

SETTING THE WORLDWIDE STANDARD IN GSE

TRONAIR®



APPLICATION REFERENCE SECTION

MANUFACTURER	PAGE	MANUFACTURER	PAGE	MANUFACTURER	PAGE
Adam	1	Dassault/Falcon	37-40	Nihon	65
Aermacchi	1	Diamond Aircraft	40	Nomad	65
Aero Vodochodoy	1	Eclipse	40	Northrop	65
Aerospatiale	1	Embraer	41-44	Piaggio	65
Airbus	2-3	Fairchild-Dorner	45-46	Pilatus	66
Airbus Helicopter (Eurocopter)	4-5	Fokker	47	Piper	67
Airbus Military (CASA)	6-7	GeneralAtomics	48	PZLMielec	67
ATR	7	General Dynamics	48	Saab	68
BAe (British Aerospace)	8-10	Grob	48	Saberliner	69
Bell	11-13	Gulfstream	49-52	Shorts	69
Boeing	14-19	Hawker Beechcraft	53-58	Sikorsky	70-71
Boeing Rotocraft	20	HondaJet	59	Sino Swearingen	72
Bombardier (Business)	20-25	IAI	60		
Bombardier (Regional)	25-28	Leonardo (Agusta Westland)	61		
Britten Norman	29	Lockheed	62		
Cessna	29-36	McDonnell Douglas	63-64		
Comac	36	Mitsubishi	65		
Daher Socata	37	Mooney	65		

PRODUCT SECTION

 markings at time of printing noted by product

PRODUCT	PAGE	PRODUCT	PAGE
LIFTING & SHORING (ATA-7)		SERVICING (ATA-12) <i>continued</i>	
Tripod Jacks	73-78	Nitrogen Boosters	109
Tripod Jack Proof Load Fixture	73	Oxygen Booster	109
Portable Tripod Jack Proof Load Tester	73	Oxygen Four Bottle Carts/Carts with Booster	110
Tripod Jack Pad Adaptors	74	Oxygen Pressure Regulators and Adaptors	110
Tripod Jack Extensions	74	Multi-Purpose Cart	111
Hand Wheel Safety Nut	75	AIR CONDITIONING (ATA-21)	
Telescoping Hydraulic Axle Jacks	79-80	Cabin Pressurization Test Units	112-113
Aircraft Recovery Dolly	80	Portable Cabin Pressurization Test Unit	114
Stabilizing Stands	81-82	Leak Fluid Dispenser	114
Stabilizing Stand Alarm Kits	82	Mobile 4 US Ton AC Environment Control Carts	115
TOWING & TAXIING (ATA-9)		ELECTRICAL (ATA-24)	
JETporter Electric Towbarless Tugs	83-84	Tier 4, 400 Hz 90kVA, Diesel Ground Power Units	116
Eagle Tugs	85-87	28.5 VDC Tier 4 Diesel Ground Power Units	117
Attachment Heads	88-90	28.5 VDC Gasoline Ground Power Unit	118
Multi-Head Towbar Systems	91	28.5 VDC Solid State Rectifiers	119-120
Portable Towbars	92	24 VDC Battery Cart - <i>1,000 Amps Peak</i>	121
Custom Towbars	93-94	Battery Charger	121
Commercial Towbars	95	Nickel Cadmium Battery Charger/Analyzer	121
Snap-Bak Towbars	96	FUEL (ATA-28)	
Portable Snap-Bak Towbars	96	Fuel Transfer Carts	122
Towbar Accessories	97	Fuel System Leak Test Unit	122
Multi-Head Storage Rack	97	Fuel Sample Test Tools	123
Telecoupler	97	Fuel Tools	123
Shear and Shock Protection	97	Fuel Sump Unit	123
PARKING & MOORING (ATA-10)		HYDRAULIC POWER (ATA-29)	
TronLock	98	Ram Air Turbine (RAT) Test Equipment	124-126
Wheel Chocks	98	Ram Air Turbine (RAT) Test Unit	124
Engine Intake Cover	98	Ram Air Turbine (RAT) Test Tool	125
SERVICING (ATA-12)		Actuator Adjustment Tool	125
Hydraulic & Engine Oil Servicing Equipment	99-102	GTT Pressure Monitoring Box	126
Skydrol Recovery Cart	100	Hydraulic Power Units - <i>Ordering Instructions</i>	127
Shimmy Damper Fluid Service Unit	101	Hydraulic Power Units - <i>Optional Features</i>	128
CSD Service Cart	101	Hydraulic Power Units - <i>Quick Select Chart</i>	129
Hydraulic & Engine Oil Servicing In-Line Filter Kits	101	Diesel Engine Driven Hydraulic Power Units	130
Military Hydraulic & Engine Oil Servicing	102	50 & 51 Series Hydraulic Power Units	131
Military PAO Service Cart	102	5J, 52, 53 & 54 Series Hydraulic Power Units	131
Hydraulic & Engine Oil Test Equipment	103	5J, 52, 53 & 54 Series Performance Curves	132
Lavatory Servicing Carts	104-105	55, 56 & 57 Series Hydraulic Power Units	133
Fittings, Connectors, Adaptors & Tools	105	55, 56 & 57 Series Performance Curves	134
Potable Water Transport Carts	106	Special Purpose Hydraulic Power Units	135
Nitrogen and Oxygen Transport Carts	107	5A, 5L, 58 & 59 Series Hydraulic Power Units	135
One and Two Bottle	107	5A, 5L, 58 & 59 Series Performance Curves	136
One and Four Bottle	107	TAD Series True Dual Hydraulic Power Units	137
International Gas Cylinder Connector Chart	107	Gasoline Engine Driven Hydraulic Power Units	138
Nitrogen & Helium Four Bottle Carts/Carts with Booster	108		

PRODUCT	PAGE
HYDRAULIC POWER (ATA-29) <i>continued</i>	
Compact Hydraulic Power Unit.....	138
Hydraulic Coupling Hose Adaptor Kits.....	139-143
Hydraulic Pressure & Return Coupling Kits	139-140
Multiple Aircraft Pressure & Return Coupling Kits	141-142
Hydraulic Reservoir Fill Coupling Kits	143
Hydraulic CSD Fill & Engine Oil Kits	143
Hydraulic CSD Overflow Kit	143
HPU Self Cleaning Circulation Kits	143
Hydraulic Fluid Laser Contamination Monitors.....	144
30° Thin Head Wrenches.....	144
Fluid Test Kit.....	145
“Super Clean” Fluid Sample Bottle	145
Fluid Sample Valve Kit.....	145
ICE & RAIN PROTECTION (ATA-30)	
Mobile Deicer Carts	146
Portable Deicer	146
Service Unit For TKS Fluid	146
LANDING GEAR (ATA-32)	
Pneumatic Driven Hydraulic Beadbreaker.....	147
Anti-Skid Test Units	147
Hydraulic Beadbreaker.....	178
Beadbreaker Adaptor Rings	148
Manual Beadbreaker	148
Landing Gear Dollies.....	148
Wheel & Brake Dolly.....	150
Wheel Dolly	150
Brake Service Units.....	151
Brake Bleed Unit.....	151
Universal Tool - Strut, Brake & Tire	152
Strut Service Tool	152
Wheel/Strut Servicing Adaptors & Connectors	153
Certified Nitrogen Service Gauges & Regulators	154
FUSELAGE (ATA-53)	
Hydraulic Maintenance Platforms.....	155
B4 and B5 Type Maintenance Platforms	156
Heavy Duty Hydraulic Utility Cranes.....	157-158
Universal Lifts.....	159
Battery Lifts.....	159
Mounted Hoist	160
PROPELLERS (ATA-61)	
Propeller Stands	161
Wall Mount Propeller SStands.....	161
Propeller and Blade Slings	161
Propeller Tools.....	161
POWER PLANT (ATA-71)	
Mobile Engine Work Stands	162
Multi-Purpose Rotating Turbine Engine Work Stands	163
Portable Turbine Engine Change Stand	164
Engine Slings.....	165-166
Portable Engine Compressor Washers	167
Engine Compressor Washers.....	168
AIRCRAFT TOOLING	
Phenom 100 & 300 Aircraft Tooling	169-170

For detailed model information reference the items page(s) • Bracketed # = quantity • R = required

Adam
A500, A700
LIFTING & SHORING - ATA 7
02-0536C0110 Main (2) 02-0526C0110 Tail 02-7947C0000
TOWING & TAXIING - ATA 9
01-2000-0000 01-1950-5000 eJP-3 eJP-3L ETT-8X TTR-6 TTR-8
PARKING & MOORING - ATA 10
99-9008-6000 99-9028-6000 99-9045-9000
SERVICING - ATA 12
ENGINE OIL
06-5009C6800 06-5010-6800 06-5022-6800 06-5042-0800
HYDRAULIC FLUID
06-4005-0800 06-4035-0800 06-5022-6800 06-5042-0800
NITROGEN
12-3104-0000 18-4200-1100 K-1225 18-4208-0010 18-4303-0000 18-4315-0000 18-4318-0000 PC-1107 K-3706
OXYGEN
12-3104-0000 12-3104-0000 20-4502-6000 20-4504-7000 20-4505-7000 20-4523-0000 20-4525-0000 PC-1006 PC-1124 K-3337
AIR CONDITIONING - ATA 21
15_7603-1000 (base model)
ELECTRICAL POWER - ATA 24
11-2820-0000 11-6602-1000 11-6644C1010 112850 112860
FUEL - ATA 28
07-3000-1921
ICE & RAIN PROTECTION - ATA 30
09-6200-0010
LANDING GEAR - ATA 32
14-6801-0120 Z-1063-09 Main (R) Z-1064-07 Nose (R)
14-6802-6000 14-6804-6000 14-6805-6010 14-6806-6030 14-6807-6011 14-6808-6000 14-6877-6012 14-6892-6000
FUSELAGE - ATA 53
04-6152-0120 K-2012 Gooseneck Boom Kit K-2013 Pneumatic Pump Kit K-2953 Hand Winch Kit
POWER PLANT - ATA 71
08-4048-0013

Aermacchi (Alenia Aeronautica)
C27J, G-222
TOWING & TAXIING - ATA 9
01-1231-0000 01A1231-0014 A1231-0024 ETT-8X ETT-12X TTR-8

Aero Vodochody
L-39NG
LIFTING & SHORING - ATA 7
02-8130C0100 K-5514 02-7947C0000
SERVICING - ATA 12
ENGINE OIL
06-5009C6800 06-5010-6800 06-5022-6800
HYDRAULIC FLUID
06-4005-0511 06-4035-0500 06-5022-6500 06-5042-0500
NITROGEN
18-4201-1010 18-4208-0010 18-4303-0000 PC-1107 18-4315-0000 K-3706 18-4318-0000 K-3706
OXYGEN
20-4500-7000 20-4502-6000 20-4504-7000 20-4505-7000 PC-1124 20-4523-0000 PC-1006 20-4525-0000 PC-1006
ELECTRICAL POWER - ATA 24
11-2820-0000 11-4290-0000 112850 112860
HYDRAULIC POWER - ATA 29
5X11-ZZ (base model)
ICE & RAIN PROTECTION - ATA 30
09-4003-4010
FUSELAGE - ATA 53
04-6028C0121 K-3057 Crane Hook Attachment Kit Z-4082 Lift Tray Assembly 04-6150-0120 K-2012 Gooseneck Boom Kit K-2013 Pneumatic Pump Kit K-2953 Hand Winch Kit

Aerospatiale
Nord 262
LIFTING & SHORING - ATA 7
02-0524C0110 Main (2) 02-0526C0110 Nose 02-7947C0000
TOWING & TAXIING - ATA 9
eJP-3 eJP-3L ETT-8X TTR-6 TTR-8
ELECTRICAL POWER - ATA 24
112850 112860
POWER PLANT - ATA 71
08-4048-0013

Airbus
A220-100 (CS100), A220-300 (CS300)
LIFTING & SHORING - ATA 7
02A7922C0100 Nose 71400A-14 Nose/Fwd 72500A-2 Wing/Main (2) 02A7945C0100 Main (2) 83200R-1 MLG 861600B NLG 03A5846C0100 Stabilizing Stand
TOWING & TAXIING - ATA 9
01B1387-0100 ETT-12X ETT-16 TTR-12
PARKING & MOORING - ATA 10
99-9028-6000
SERVICING - ATA 12
ENGINE OIL
06-5022-6800 06-5042-0800 06-5083-0800
HYDRAULIC FLUID
06-4005-3611 06-5020-0800 06-5022-6600 06-5024-3610
LAVATORY
10-6401-0010 K-2410 (R) K-2922 (R) 10-6411-0000 K-2410 (R) K-2922 (R)
POTABLE WATER
19-4301-0000 19-4303-0000 K-2411
NITROGEN
18-4318-0000 PC-1107 K-3706 18-4318-0000 PC-1107 K-3706
OXYGEN
20-4500-7000 20-4502-6000 20-4504-7000 20-4505-7000 20-4523-0000 20-4525-0000 PC-1006 PC-1009 PC-1124
AIR CONDITIONING - ATA 21
15 7610-6000 (base model) 15D7603-1000 15K7603-1000
ELECTRICAL POWER - ATA 24
11-4090-0000 11-4290-0000
HYDRAULIC POWER - ATA 29
5833-KY (base model) Recommended: 58331LA_CMY4 KHC-3559 KHC-4030 AGE17631B 13-6622-0000 06-5051-6600 K-4388 (R)
LANDING GEAR - ATA 32
14-6802-6000 14-6804-6000 14-6805-6010 14-6806-6030 14-6807-6011 14-6808-6000 14-6833-6030 14-6878-0110 14-6883-0110 14-6892-6000 14-6918-6600 K-3025
FUSELAGE - ATA 53
04-6001-1100 04-6005-1100 04-6028C0121 04-6030-5111

Airbus
A300, A310
LIFTING & SHORING - ATA 7
73300A-11 Nose/Fwd 881100B-7 Wing/Main (2) 848700A-2 Tail/Aft 848700A-2 NLG/MLG 874600-8 Axle
TOWING & TAXIING - ATA 9
A004190D ETT-16 XM-20
SERVICING - ATA 12
ENGINE OIL
06-5022-6800 06-5024-3800 06-5042-0800 06-5073-0800 K-2258 (R) K-2173
HYDRAULIC FLUID
06-4005-3611 06-4035-3600 06-5022-6600 06-5024-3610 06-5043-3600 KHC-1014
LAVATORY
10-6401-0010 K-2029 (R) K-2410 (R) K-3606 10-6411-0000 K-2029 (R) K-2410 (R) K-3606 10-6403-6000
POTABLE WATER
19-4301-0000 K-2411
NITROGEN
18-4201-1010 K-1225 18-4208-0010 18-4303-0000 18-4315-0000 18-4318-0000 PC-1107 K-3706
OXYGEN
20-4500-7000 20-4502-6000 20-4504-7000 20-4505-7000 20-4523-0000 20-4525-0000 PC-1006 PC-1009 PC-1124
ELECTRICAL POWER - ATA 24
11-4090-0000 11-4290-0000 11-6610-6000
FUEL - ATA 28
07-3000-1921 07-3026-6900
HYDRAULIC POWER - ATA 29
(recommended base models) 5833-BJ (60 hz countries) 5A33-BJ (50 hz countries) KHC-1468
LANDING GEAR - ATA 32
14-6878-0110 14-6883-0110 17500M BC400P (R) 17500S-2 BC400P (R)
FUSELAGE - ATA 53
04-6001-1100 04-6030-5111

Airbus
A318, A319
LIFTING & SHORING - ATA 7
872100A-4 Nose/Fwd 73300A-10 Wing/Main (2) 872200A-6 Tail/Aft 882100-6 (50P9AR) NLG/MLG 891900 NLG/MLG Fly-Away 64200S NLG
TOWING & TAXIING - ATA 9
A003817D ETT-16 XM-20
SERVICING - ATA 12
ENGINE OIL
06-5022-6800 06-5024-3800 06-5042-0800 06-5073-0800 KHC-2258 (R) KHC-2173 (R)
HYDRAULIC FLUID
06-4005-3611 06-4035-3600 06-5022-6600 06-5024-3610 06-5043-3600 KHC-1014
LAVATORY
10-6401-0010 K-2029 (R) K-2410 (R) K-3606 10-6403-6000 10-6411-0000 K-2029 (R) K-2410 (R) K-3606
POTABLE WATER
19-4301-0000 K-2411
NITROGEN
18-4201-1010 K-1225 18-4208-0010 18-4303-0000 18-4315-0000 18-4318-0000 PC-1107 K-3706
OXYGEN
20-4500-7000 20-4502-6000 20-4504-7000 20-4505-7000 20-4523-0000 20-4525-0000 PC-1124
ELECTRICAL POWER - ATA 24
11-4090-0000 11-4290-0000 11-6610-6000
HYDRAULIC POWER - ATA 29
(recommended base models) 5833-BJ (60 hz countries) 5A33-BJ (50 hz countries) KHC-1468 06-5051-6600 K-4388 (R) 13-6600-3600 AGE10600D
LANDING GEAR - ATA 32
14-6878-0110 14-6883-0110 17500M - A319 only BC400P (R) 17500S-2 - A319 only BC400P (R)
FUSELAGE - ATA 53
04-6001-1100 04-6030-5111

Airbus
A320, A321, A321 Neo
LIFTING & SHORING - ATA 7
872100A-4 Nose/Fwd 73300A-10 Wing/Main (2) 872200A-6 Tail/Aft 882100-6 (50P9AR) NLG/MLG 891900 NLG/MLG Fly-Away 64200S NLG
TOWING & TAXIING - ATA 9
A003817D XM-20 XM-30
SERVICING - ATA 12
ENGINE OIL
06-5022-6800 06-5024-3800 06-5042-0800 06-5073-0800 KHC-2258 (R) KHC-2173 (R)
HYDRAULIC FLUID
06-4005-3611 06-4035-3600 06-5022-6600 06-5024-3610 06-5043-3600 KHC-1014
LAVATORY
10-6401-0010 K-2029 (R) K-2410 (R) K-3606 10-6403-6000 10-6411-0000 K-2029 (R) K-2410 (R) K-3606
POTABLE WATER
19-4301-0000 K-2411
NITROGEN
18-4201-1010 K-1225 18-4208-0010 18-4303-0000 18-4315-0000 18-4318-0000 PC-1107 K-3706
OXYGEN
20-4500-7000 20-4502-6000 20-4504-7000 20-4505-7000 20-4523-0000 20-4525-0000 PC-1124
ELECTRICAL POWER - ATA 24
11-4090-0000 11-4290-0000 11-6610-6000
HYDRAULIC POWER - ATA 29
(recommended base models) 5833-BJ (60 hz countries) 5A33-BJ (50 hz countries) KHC-1468 06-5051-6600 K-4388 (R) 13-6600-3600 AGE10600D
LANDING GEAR - ATA 32
14-6878-0110 14-6883-0110 17500M BC400P (R) 17500S-2 BC400P (R)
FUSELAGE - ATA 53
04-6001-1100 04-6030-5111

For detailed model information reference the items page(s) • Bracketed # = quantity • R = required

Airbus
A330-200/300, A340-200/300
LIFTING & SHORING - ATA 7
881100B-11-5 Wing/Main (2) 876000-3 Nose/Fwd 871400 NLG/MLG Fly-Away 876100-3 Tail/Aft A330-200/300 only : 874600-8 (65P10AR) NLG/MLG
TOWING & TAXIING - ATA 9
A212636D
SERVICING - ATA 12
ENGINE OIL
06-5022-6800 06-5024-3800 06-5042-0800 06-5073-0800 KHC-2258 (R) KHC-2173 (R)
HYDRAULIC FLUID
06-4005-3611 06-4035-3600 06-5022-6600 06-5024-3610 06-5043-3600 KHC-1014
NITROGEN
18-4201-1010 K-1225 18-4208-0010 18-4303-0000 18-4315-0000 18-4318-0000 PC-1107 K-3706
OXYGEN
20-4500-7000 20-4502-6000 20-4504-7000 20-4505-7000 20-4523-0000 20-4525-0000 PC-1124
ELECTRICAL POWER - ATA 24
11-4090-0000 11-4290-0000 11-6610-6000
HYDRAULIC POWER - ATA 29
(base models) 5833-BJ (60 hz countries) 5A33-BJ (50 hz countries) Recommended 58331BJ_B4 (60 hz countries) 5A331BJ_B4 (50 hz countries) KHC-1468 13-6600-3600 AGE10600D 06-5051-6600 K-2340 (R)
LANDING GEAR - ATA 32
14-6878-0110 14-6883-0110 17500M BC500P (R) 17500S-2 BC500P (R)
FUSELAGE - ATA 53
04-6001-1100 04-6030-5111

Airbus
A340-500/600
LIFTING & SHORING - ATA 7
881100B-11-5 Wing/Main (2) 876000-3 Nose/Fwd 892000 NLG/MLG Fly-Away 876100-3 Tail/Aft
TOWING & TAXIING - ATA 9
A005265D
SERVICING - ATA 12
ENGINE OIL
06-5022-6800 06-5024-3800 06-5042-0800 06-5073-0800 KHC-2258 (R) KHC-2173 (R)
HYDRAULIC FLUID
06-4005-3611 06-4035-3600 06-5022-6600 06-5024-3610 06-5043-3600 KHC-1014
NITROGEN
18-4201-1010 K-1225 18-4208-0010 18-4303-0000 18-4315-0000 18-4318-0000 PC-1107 K-3706
OXYGEN
20-4500-7000 20-4502-6000 20-4504-7000 20-4505-7000 20-4523-0000 20-4525-0000 PC-1124
ELECTRICAL POWER - ATA 24
11-4090-0000 11-4290-0000 11-6610-6000
HYDRAULIC POWER - ATA 29
(base models) 5833-BJ (60 hz countries) 5A33-BJ (50 hz countries) Recommended 58331BJ_B4 (60 hz countries) 5A331BJ_B4 (50 hz countries) KHC-1468 13-6600-3600 AGE10600D 06-5051-6600 K-4388 (R)
LANDING GEAR - ATA 32
14-6878-0110 14-6883-0110 17500M BC500P (R) 17500S-2 BC500P (R)
FUSELAGE - ATA 53
04-6001-1100 04-6030-5111

Airbus
A350-900/1000
LIFTING & SHORING - ATA 7
881100B-10 Nose/Fwd 881100B-11-5 Wing/Main (2) 885500-8 (65P10AR) NLG/MLG 892000 NLG/MLG Fly-Away 876100-3 Tail/Aft
TOWING & TAXIING - ATA 9
A212636D
SERVICING - ATA 12
SUPPLEMENTAL COOLANT SYSTEM FILL/DRAIN CART
1016 1016309 (R) 1016310 (R) PF56201
ENGINE OIL
06-5022-6800 06-5024-3800 06-5042-0800 06-5073-0800 KHC-2258 (R) KHC-2173
HYDRAULIC FLUID
06-4005-3611 06-4035-3600 06-5022-6600 06-5024-3610 06-5043-3600 KHC-1014
NITROGEN
18-4201-1010 K-1225 18-4208-0010 18-4303-0000 18-4315-0000 18-4318-0000 PC-1107 K-3706
OXYGEN
20-4500-7000 20-4502-6000 20-4504-7000 20-4505-7000 20-4523-0000 20-4525-0000 PC-1124
ELECTRICAL POWER - ATA 24
11-4090-0000 11-4290-0000 11-6610-6000
HYDRAULIC POWER - ATA 29
(base models) 5933 (60 hz countries) 5L33 (50 hz countries) Recommended 59331GW_BBC4 (60 hz countries) 5L331GW_BBC4 (50 hz countries) 693A KHC-4010 06-5051-6600 K-4388
LANDING GEAR - ATA 32
17500M BC500P 17500S-2 BC500P

Airbus
A380
TOWING & TAXIING - ATA 9
01-1317-0000
SERVICING - ATA 12
ENGINE OIL
06-5022-6800 06-5024-3800 06-5042-0800 06-5073-0800 KHC-2258 (R) KHC-2173
HYDRAULIC FLUID
06-4005-3611 06-4035-3600 06-5022-6600 06-5024-3610 06-5043-3600 KHC-1014
NITROGEN
18-4201-1010 K-1225 18-4208-0010 18-4303-0000 18-4315-0000 18-4318-0000 PC-1107 K-3706
OXYGEN
20-4500-7000 20-4502-6000 20-4504-7000 20-4505-7000 20-4523-0000 20-4525-0000 PC-1124
ELECTRICAL POWER - ATA 24
11-4090-0000 11-4290-0000 11-6610-6000
HYDRAULIC POWER - ATA 29
(base models) 5933 (60 hz countries) 5L33 (50 hz countries) Recommended 59331GW_BBC4 (60 hz countries) 5L331GW_BBC4 (50 hz countries) 693A KHC-4010 06-5051-6600 K-4388
LANDING GEAR - ATA 32
17500M BC500P 17500S-2 BC500P

AS355 Twin Star
LIFTING & SHORING - ATA 7
02-0511C0132 Fwd (2) 02A7898C0100 Fwd (2) 02-0222C0111 Aft 02-7947C0000
TOWING & TAXIING - ATA 9
TTR-6

Airbus Helicopter (Eurocopter)
AS330 Puma
LIFTING & SHORING - ATA 7
02-7934C0100 Nose 02-7934C0100 Main (2)
TOWING & TAXIING - ATA 9
01-1202-0000 01-0577-0020 (R) 01-1215-0000 01-0577-0020 (R) 01-1950-5000 01-1954-6000 01-1954-6002 XM-20 XM-30
PARKING & MOORING - ATA 10
99-9028-6000
SERVICING - ATA 12
ENGINE OIL
06-5009C6800 06-5010-6800 06-5022-6800
HYDRAULIC FLUID
06-4005-0511 06-4035-0500 06-5022-6500 06-5042-0500
NITROGEN
18-4201-1010 K-1225 18-4208-0010 18-4303-0000 18-4315-0000 18-4318-0000 PC-1107 K-3706
ELECTRICAL POWER - ATA 24
11-2820-0000 11-6610-6000 112850 112860
FUEL - ATA 28
07-3000-1921 07-3006-6900
HYDRAULIC POWER - ATA 29
52211BF (base model) K-4492 (R) KHC-1306
ICE & RAIN PROTECTION - ATA 30
09-4003-4010 09-6200-0010
LANDING GEAR - ATA 32
14-6801-0120 Z-1063-07 Main (R) Z-1063-07 Nose (R) 14-6802-6000 14-6804-6000 14-6805-6010 14-6806-6011 14-6807-6011 14-6808-6000 14-6830-6012 14-6883-0110 14-6892-6000 14-4039-0010
FUSELAGE - ATA 53
04-6028C0121 K-3057 Crane Hook (R) 04-6029-5111 04-6029-5111-A5 04-6029-5111 04-6029-5111-A5 04-6150-0120 K-2012 Gooseneck Boom Kit K-2013 Pneumatic Pump Kit K-2953 Hand Winch Kit
POWER PLANT - ATA 71
08-4048-0013 K-4500 (R) for Turbomecs Arriel/Makila engines

Airbus Helicopter (Eurocopter)
AS332 Super Puma
LIFTING & SHORING - ATA 7
02-7934C0100 Nose 02-7934C0100 Main (2)
TOWING & TAXIING - ATA 9
01-1202-0000 01-0577-0020 (R) 01-1215-0000 01-0577-0020 (R) 01-1950-5000 01-1954-6000 01-1954-6002 TTR-6 TTR-8 ETT-8X
PARKING & MOORING - ATA 10
99-9028-6000
SERVICING - ATA 12
ENGINE OIL
06-5009C6800 06-5010-6800 06-5022-6800
HYDRAULIC FLUID
06-4005-0511 06-4035-0500 06-5022-6500 06-5042-0500
NITROGEN
18-4201-1010 K-1225 18-4208-0010 18-4303-0000 18-4315-0000 18-4318-0000 PC-1107 K-3706
ELECTRICAL POWER - ATA 24
11-2820-0000 11-6610-6000 112850 112860
FUEL - ATA 28
07-3000-1921 07-3006-6900
HYDRAULIC POWER - ATA 29
52211BF (base model) K-4492 (R) KHC-1306
ICE & RAIN PROTECTION - ATA 30
09-4003-4010 09-6200-0010
LANDING GEAR - ATA 32
14-6801-0120 Z-1063-07 Main (R) Z-1063-07 Nose (R) 14-6802-6000 14-6804-6000 14-6805-6010 14-6806-6011 14-6807-6011 14-6808-6000 14-6830-6012 14-6883-0110 14-6892-6000 14-4039-0010
FUSELAGE - ATA 53
04-6028C0121 K-3057 Crane Hook (R) 04-6029-5111 04-6029-5111-A5 04-6029-5111 04-6029-5111-A5 04-6150-0120 K-2012 Gooseneck Boom Kit K-2013 Pneumatic Pump Kit K-2953 Hand Winch Kit
POWER PLANT - ATA 71
08-4048-0013 K-4500 (R) for Turbomecs Arriel/Makila engines

Airbus Helicopter (Eurocopter)
AS365N Dauphin
LIFTING & SHORING - ATA 7
02-0526C0110 Fwd (2) HJ-514 (2) (R) 02-0517C0140 Aft 02-7947C0000
TOWING & TAXIING - ATA 9
01-1202-0000 01-0556-0020 (R) 01-1148-0000 01-1338-0000 01-1339-0000 01-1954-6000 01-1954-6002 TTR-6
PARKING & MOORING - ATA 10
99-9028-6000
SERVICING - ATA 12
ENGINE OIL
06-5009C6800 06-5010-6800 06-5022-6800
HYDRAULIC FLUID
06-4005-0511 06-4035-0500 06-5022-6500 06-5042-0500
NITROGEN
18-4201-1010 K-1225 18-4208-0010 18-4303-0000 18-4315-0000 18-4318-0000 PC-1107 K-3706
ELECTRICAL POWER - ATA 24
11-2820-0000 11-6610-6000 112850 112860
FUEL - ATA 28
07-3000-1921 07-3006-6900
HYDRAULIC POWER - ATA 29
52211BF (base model) K-4492 (R) KHC-1306
ICE & RAIN PROTECTION - ATA 30
09-4003-4010 09-6200-0010
LANDING GEAR - ATA 32
14-6801-0120 Z-1063-07 Main (R) Z-1063-07 Nose (R) 14-6802-6000 14-6804-6000 14-6805-6010 14-6806-6011 14-6807-6011 14-6808-6000 14-6830-6012 14-6883-0110 14-6892-6000 14-4039-0010
FUSELAGE - ATA 53
04-6028C0121 K-3057 (R) 04-6029-5111 04-6029-5111-A5 04-6029-5111 04-6150-0120 K-2012 Gooseneck Boom Kit K-2013 Pneumatic Pump Kit K-2953 Hand Winch Kit
POWER PLANT - ATA 71
08-4048-0013 K-4500 (R) for Turbomecs Arriel/Makila engines

Airbus Helicopter (Eurocopter)
AS532 Cougar, H225 (EC225 Super Pump MKII+), H225M (EC725 Super Cougar)
LIFTING & SHORING - ATA 7
02-7934C0100 Nose 02-7934C0100 Main (2) 02-7813C0100 Axle
TOWING & TAXIING - ATA 9
01-1202-0000 01-0577-0020 (R) 01-1215-0000 01-0577-0020 (R) 01-1950-5000 01-1954-6000 01-1954-6002 TTR-6
PARKING & MOORING - ATA 10
99-9028-6000
SERVICING - ATA 12
ENGINE OIL
06-5009C6800 06-5010-6800 06-5022-6800
HYDRAULIC FLUID
06-4005-0511 06-4035-0500 06-5022-6500 06-5042-0500
NITROGEN
18-4201-1010 K-1225 18-4208-0010 18-4303-0000 18-4315-0000 18-4318-0000 PC-1107 K-3706
ELECTRICAL POWER - ATA 24
11-2820-0000 11-6610-6000 112850 112860
FUEL - ATA 28
07-3000-1921 07-3006-6900
HYDRAULIC POWER - ATA 29
5221EB_C (base model) KHC-1005 KHC-4020
ICE & RAIN PROTECTION - ATA 30
09-4003-4010
LANDING GEAR - ATA 32
14-6801-0120 Z-1063-08 Main (R) Z-1063-13 Nose (R) 14-6802-6000 14-6804-6000 14-6805-6010 14-6806-6011 14-6807-6011 14-6808-6000 14-6883-0110 14-6892-6000 14-4039-0010
FUSELAGE - ATA 53
04-6150-0120 K-2012 Gooseneck Boom Kit K-2013 Pneumatic Pump Kit K-2953 Hand Winch Kit 04-6029-5111 04-6029-5111-A5
POWER PLANT - ATA 71
08-4048-0013 K-4500 (R) for Turbomecs Arriel/Makila engines

For detailed model information reference the items page(s) • Bracketed # = quantity • R = required

Airbus Helicopter (Eurocopter)
BK-117, BO-105
LIFTING & SHORING - ATA 7
02-0511C0132 Fwd (2) 02A7898C0100 Fwd (2) 02-0511C0132 Aft 02A7898C0100 Aft 02-7947C0000
TOWING & TAXIING - ATA 9
TTR-6
SERVICING - ATA 12
ENGINE OIL
06-5009C6800 06-5010-6800 06-5022-6800
HYDRAULIC FLUID
06-4005-0511 06-4035-0500 06-5022-6500 06-5042-0500
NITROGEN
18-4201-1010 K-1225 18-4208-0010 18-4303-0000 18-4315-0000 18-4318-0000 PC-1107 K-3706
ELECTRICAL POWER - ATA 24
11-2820-0000 11-6602-1000 11-6610-6000 112850 112860 92-0552-9010
FUEL - ATA 28
07-3000-1921 07-3006-6900
HYDRAULIC POWER - ATA 29
51101AV (base model) 51101AE (base model) (BK-117 only) KHC-1075
ICE & RAIN PROTECTION - ATA 30
09-4003-4010
FUSELAGE - ATA 53
04-6028C0121 Z-4082 Lift Tray (R) 04-6029-5111 04-6029-5111-A5 04-6150-0120 K-2012 Gooseneck Boom Kit K-2013 Pneumatic Pump Kit K-2953 Hand Winch Kit
POWER PLANT - ATA 71
08-0104-4000 (Allison 250) 08-0133-4000 (LTS 101) 08-2023-0010 K-2108 (R) (Allison 250) K-2908 (R) (LTS 101) 08-4048-0013 K-4500 (R) for Turbomecs Arriel/Makila engines

HH-65A Dolphin
LIFTING & SHORING - ATA 7
02-0527C0140 Fwd (2) 02-0526C0110 Aft (2) HJ-514 02-7813C0100 Axle
TOWING & TAXIING - ATA 9
01-1201-0000 01-0850-0000 (R) 01-1210-0010 TTR-6
ELECTRICAL POWER - ATA 24
11-2820-0000
HYDRAULIC POWER - ATA 29
51201FF_D (base model) KHC-1306

Airbus Helicopter (Eurocopter)
H125 (AS350 A-Star)
LIFTING & SHORING - ATA 7
AS350 A-Star (high skid gear): 02-0222C0111 Fwd (2) 02-0234-0111 Aft 02-7947C0000
AS350 A-Star (low skid gear): 02-0511C0132 Fwd (2) 02A7989C0100 Fwd (2) 02-0222C0111 Aft 02-7947C0000
TOWING & TAXIING - ATA 9
TTR-6
ELECTRICAL POWER - ATA 24
11-2820-0000 112850 112860

H135 (EC135), H145 (CE145), UH-72A Lakota
LIFTING & SHORING - ATA 7
02-0511C0132 Fwd (2) 02A7898C0100 Fwd (2) 02-0511C0132 Aft 02A7898C0100 Aft 02-7947C0000
TOWING & TAXIING - ATA 9
TTR-6
SERVICING - ATA 12
ENGINE OIL
06-5009C6800 06-5010-6800 06-5022-6800
HYDRAULIC FLUID
06-4005-0511 06-4035-0500 06-5022-6500 06-5042-0500
NITROGEN
18-4201-1010 K-1225 18-4208-0010 18-4303-0000 18-4315-0000 18-4318-0000 PC-1107 K-3706
ELECTRICAL POWER - ATA 24
11-2820-0000 11-6602-1000 11-6610-6000 112850 112860 92-0552-9010
FUEL - ATA 28
07-3000-1921 07-3006-6900
ICE & RAIN PROTECTION - ATA 30
09-4003-4010
FUSELAGE - ATA 53
04-6028C0121 Z-4082 Lift Tray (R) 04-6029-5111 04-6029-5111-A5 04-6150-0120 K-2012 Gooseneck Boom Kit K-2013 Pneumatic Pump Kit K-2953 Hand Winch Kit
POWER PLANT - ATA 71
08-4048-0013 K-4500 (R) for Turbomecs Arriel/Makila engines

Airbus Helicopter (Eurocopter)
H155 (EC155)
LIFTING & SHORING - ATA 7
02-7813C0100 Axle
TOWING & TAXIING - ATA 9
01-1202-0000 01-0577-0020 (R) 01-1148-0000 01-1954-6000 01-1954-6002 TTR-6
PARKING & MOORING - ATA 10
99-9028-6000
HYDRAULIC POWER - ATA 29
5221FF_C K-4492 (R) KHC-1036

H160
LIFTING & SHORING - ATA 7
02A7898C0100 Fwd (2) 02A1032C0111 Aft (2) 02A17934C0100 Aft (2)(alternate) 02-7861C0100 Axle 02-7947C0000
TOWING & TAXIING - ATA 9
01-1202-0000 01-0627-0000 (R)
PARKING & MOORING - ATA 10
99-9028-6000
SERVICING - ATA 12
ENGINE OIL
06-5009C6800 06-5010-6800 06-5022-6800
HYDRAULIC FLUID
06-4005-0511 06-4035-0500 06-5022-6500 06-5042-0500
NITROGEN
18-4201-1010 K-1225 18-4208-0010 18-4303-0000 K-3706 PC-1107
ELECTRICAL POWER - ATA 24
11-2820-0000 11-6610-6000 112850 112860
FUEL - ATA 28
07-3000-1921 07-3006-6900
HYDRAULIC POWER - ATA 29
5421EB_C (base model) KHC-1005 KHC-4020
ICE & RAIN PROTECTION - ATA 30
09-4003-4010
LANDING GEAR - ATA 32
14-6801-0120 Z-1063-11Main (R) Z-1063-08 Nose (R)
14-6802-6000 14-6804-6000 14-6805-6010 14-6806-6011 14-6807-6011 14-6808-6000 14-6883-0110 14-6892-6000 14-4039-0010
FUSELAGE - ATA 53
04-6029-5111 04-6150-0120 K-2012 Gooseneck Boom Kit K-2013 Pneumatic Pump Kit K-2953 Hand Winch Kit
POWER PLANT - ATA 71
08-4049-0013

Airbus Helicopter (Eurocopter)
H175 (EC175)
LIFTING & SHORING - ATA 7
02A7898C0100 Fwd (2) 02A1032C0111 Aft (2) 02-7813C0100 Axle
TOWING & TAXIING - ATA 9
01-1202-0000 Head (R) (TBD) 01-1954-6000 TTR-6
PARKING & MOORING - ATA 10
99-9028-6000
SERVICING - ATA 12
ENGINE OIL
06-5009C6800 06-5010-6800 06-5022-6800
HYDRAULIC FLUID
06-4005-0511 06-4035-0500 06-5022-6500
NITROGEN
18-4201-1010 K-1225 18-4208-0010 18-4303-0000
18-4315-0000 18-4318-0000 PC-1107 K-3706
ELECTRICAL POWER - ATA 24
11-2820-0000 11-6610-6000 112850 112860
FUEL - ATA 28
07-3000-1921 07-3006-6900
HYDRAULIC POWER - ATA 29
5221EB_C (base model) KHC-1005 KHC-4020
ICE & RAIN PROTECTION - ATA 30
09-4003-4010
LANDING GEAR - ATA 32
14-6801-0120 Z-1063-13 Main (R) Z-1063-08 Nose (R)
14-6802-6000 14-6804-6000 14-6805-6010 14-6806-6011 14-6807-6011 14-6808-6000 14-6883-0110 14-6892-6000 14-4039-0010
FUSELAGE - ATA 53
04-6029-5111 04-6029-5111-A5 04-6150-0120 K-2012 Gooseneck Boom Kit K-2013 Pneumatic Pump Kit K-2953 Hand Winch Kit
POWER PLANT - ATA 71
08T4049-0013

Airbus Military (CASA)	
212-100/200	
LIFTING & SHORING - ATA 7	FUSELAGE - ATA 53
02-7804C0110 Main (2) 02-0517C0140 Nose 02-7947C0000 03-5808-0000 Stabilizing Stand	04-6028C0121 Z-4082 Lift Tray (R) 04-6029-5111 04-6029-5111-A5 04-6029-5111 04-6029-5111-A5 04-6150-0120 K-2012 Gooseneck Boom Kit K-2013 Pneumatic Pump Kit K-2953 Hand Winch Kit
TOWING & TAXIING - ATA 9	POWER PLANT - ATA 71
01-1201-0000 01-0531-0000 (R) 01-1216-0000 01-0531-0000 (R) 01-1954-6000 01-1954-6002 eJP-3 eJP-3L	08-0103-4000 08-2013-0010 K-2110 (R) 08-4048-0013
SERVICING - ATA 12	
ENGINE OIL	
06-5009C6800 06-5010-6800 06-5022-6800 06-5042-0800	
HYDRAULIC FLUID	
06-4005-0511 06-4035-0500 06-5022-6500 06-5042-0500	
LAVATORY	
10-4036-0010 K-2029 (R) K-2410 (R) 10-6409-0000 10-6408-0000 K-2029 (R) K-2410 (R)	
POTABLE WATER	
19-4305-0000 19-4306-0000 K-2411	
NITROGEN	
18-4201-1010 K-1225 18-4208-0010 18-4303-0000 18-4315-0000 18-4318-0000 PC-1107 K-3706	
OXYGEN	
20-4500-7000 20-4502-6000 20-4504-7000 20-4505-7000 20-4523-0000 20-4525-0000 PC-1124	
ELECTRICAL POWER - ATA 24	
11-2820-0000 11-6610-6000 112850 112860	
FUEL - ATA 28	
07-3000-1921 07-3006-6900	
ICE & RAIN PROTECTION - ATA 30	
09-6200-0010	
LANDING GEAR - ATA 32	
14-6801-0120 Z-1063-13 Main (R) Z-1063-15 Nose (R) 14-6802-6000 14-6804-6000 14-6805-6010 14-6806-6011 14-6807-6011 14-6808-6000 14-6883-0110 14-6892-6000	

A330-MRTT
LIFTING & SHORING - ATA 7
A212636D
SERVICING - ATA 12
ENGINE OIL
06-5073-0800 KHC-2173 CSD Fill
HYDRAULIC POWER - ATA 29
5833-BJ (base model) KHC-1468 13-6600-3600 AGE106005

A400M
HYDRAULIC POWER - ATA 29
(base models) 5933-GW (50 hz countires) 5L33-GW (60 hz countires) 693A AGE17079A AGE18380

Airbus Military (CASA)	
C-295	
LIFTING & SHORING - ATA 7	LANDING GEAR - ATA 32
02-1036C0111 Main (2) 02-7809C0111 Nose 02-7947C0000 03-5806-0000 Stabilizing Stand K-3864 03A5806-0000 Stabilizing Stand	14-6801-0120 Z-1063-14 Main (R) Z-1063-13 Nose (R) 14-6802-6000 14-6804-6000 14-6805-6010 14-6806-6011 14-6807-6011 14-6808-6000 14-6883-0110 14-6892-6000
TOWING & TAXIING - ATA 9	FUSELAGE - ATA 53
01-1280-0000 ETT-8X ETT-12X TTR-6 TTR-8	04-6028C0121 Z-4082 Lift Tray (R) 04-6029-5111 04-6029-5111-A5 04-6150-0120 K-2012 Gooseneck Boom Kit K-2013 Pneumatic Pump Kit K-2953 Hand Winch Kit
SERVICING - ATA 12	POWER PLANT - ATA 71
ENGINE OIL	08-0134-4000 K-2909 (R) 08-0106-4000 08-0108-4000 08-4048-0013
06-5009C6800 06-5010-6800 06-5022-6800	
HYDRAULIC FLUID	
06-4005-0511 06-4035-0500 06-5022-6500 06-5042-0500	
LAVATORY	
10-4036-0010 K-2410 (R) K-2412 (R) 10-6403-6000 10-6408-0000 K-2410 (R) K-2412 (R) 10-6409-0000	
POTABLE WATER	
19-4305-0000 19-4306-0000 K-2411	
NITROGEN	
18-4201-1010 K-1225 18-4208-0010 18-4303-0000 18-4315-0000 18-4318-0000 PC-1107 K-3706	
OXYGEN	
20-4500-7000 20-4502-6000 20-4504-7000 20-4505-7000 20-4523-0000 20-4525-0000 PC-1124 PC-1006 PC-1009	
ELECTRICAL POWER - ATA 24	
11-2820-0000 11-6610-6000 112850 112860	
FUEL - ATA 28	
07-3000-1921 07-3006-6900	
HYDRAULIC POWER - ATA 29	
5211-BL (base model) KHC-1858	
ICE & RAIN PROTECTION - ATA 30	
09-6200-0010	

For detailed model information reference the items page(s) • Bracketed # = quantity • R = required

Airbus Military (CASA)	
CN-235, HC-144A	
LIFTING & SHORING - ATA 7	LANDING GEAR - ATA 32
02-1036C0111 Main (2)	14-6801-0120
02-0517C0140 Nose	Z-1063-14 Main (R)
02-7813C0100 Axle	Z-1063-13 Nose (R)
02-7947C0000	14-6802-6000
03-5806-0000 Stabilizing Stand	14-6804-6000
K-3864	14-6805-6010
03A5806-0000 Stabilizing Stand	14-6806-6011
TOWING & TAXIING - ATA 9	14-6807-6011
01-1201-0010	14-6808-6000
01-0552-0011 (R)	14-6883-0110
01-1189-0012	14-6892-6000
01-1310-0000	FUSELAGE - ATA 53
01-1950-5000	04-6028C0121
01-1954-6000	Z-4082 Lift Tray (R)
01-1954-6002	04-6029-5111
ETT-8X	04-6029-5111-A5
TTR-6	04-6150-0120
TTR-8	K-2012 Gooseneck Boom Kit
SERVICING - ATA 12	K-2013 Pneumatic Pump Kit
ENGINE OIL	K-2953 Hand Winch Kit
06-5009C6800	POWER PLANT - ATA 71
06-5010-6800	08-0134-4000
06-5022-6800	K-2909 (R)
HYDRAULIC FLUID	08-0106-4000
06-4005-0511	08-0108-4000
06-4035-0500	08-4048-0013
06-5022-6500	
06-5042-0500	
06-5043-1500	
LAVATORY	
10-4036-0010	
K-2410 (R)	
K-2412 (R)	
10-6403-6000	
10-6408-0000	
K-2410 (R)	
K-2412 (R)	
10-6409-0000	
POTABLE WATER	
19-4305-0000	
19-4306-0000	
K-2411	
NITROGEN	
18-4201-1010	
K-1225	
18-4208-0010	
18-4303-0000	
18-4315-0000	
18-4318-0000	
PC-1107	
K-3706	
OXYGEN	
20-4500-7000	
20-4502-6000	
20-4504-7000	
20-4505-7000	
20-4523-0000	
20-4525-0000	
PC-1124	
PC-1006	
PC-1009	
ELECTRICAL POWER - ATA 24	
11-2820-0000	
11-6610-6000	
112850	
112860	
FUEL - ATA 28	
07-3000-1921	
07-3006-6900	
HYDRAULIC POWER - ATA 29	
5211-BL (base model)	
KHC-1858	
ICE & RAIN PROTECTION - ATA 30	
09-6200-0010	

ATR	
42, 72	
LIFTING & SHORING - ATA 7	LANDING GEAR - ATA 32
02-7802C0111 Main (2)	14-6801-0120
02-7822C0110 Nose (2)	Z-1063-19 Main (R)
R-1239 (2) (R)	Z-1063-08 Nose (R)
02-7827C0110 Tail	14-6802-6000
02-7947C0000	14-6804-6000
02-7813C0100 Axle Nose/Main	14-6805-6010
TOWING & TAXIING - ATA 9	14-6806-6011
01-1201-0010	14-6807-6011
01-0610-0000 (R)	14-6808-6000
01-1290-0100	14-6883-0110
01-0610-0000 (R)	14-6892-6000
01-1950-5000	FUSELAGE - ATA 53
01-1954-6000	04-6028C0121
01-1954-6002	K-3057 Crane Hook (R)
ETT-8X	Z-4082 Lift Tray (R)
TTR-6	04-6029-5111
TTR-8	04-6029-5111-A5
PARKING & MOORING - ATA 10	04-6150-0120
99-9028-6000	K-2012 Gooseneck Boom Kit
SERVICING - ATA 12	K-2013 Pneumatic Pump Kit
ENGINE OIL	K-2953 Hand Winch Kit
06-5009C6800	POWER PLANT - ATA 71
06-5010-6800	08-0134-4000
06-5022-6800	K-2909 (R)
HYDRAULIC FLUID	08-0106-4000
06-4005-0511	08-0108-4000
06-4035-0500	08-4048-0013
06-5022-6500	
06-5042-0500	
06-5043-1500	
KHC-1089	
LAVATORY	
10-6402-0010	
K-2029 (R)	
K-2410 (R)	
10-6403-6000	
10-6412-0000	
K-2029 (R)	
K-2410 (R)	
POTABLE WATER	
19-4305-0000	
19-4306-0000	
K-2411	
NITROGEN	
18-4201-1010	
K-1225	
18-4208-0010	
18-4303-0000	
18-4315-0000	
18-4318-0000	
PC-1107	
K-3706	
OXYGEN	
20-4500-7000	
20-4502-6000	
20-4504-7000	
20-4505-7000	
20-4523-0000	
20-4525-0000	
PC-1124	
PC-1006	
PC-1009	
ELECTRICAL POWER - ATA 24	
11-2820-0000	
11-4090-0000	
11-4290-0000	
11-6610-6000	
112850	
112860	
FUEL - ATA 28	
07-3000-1921	
07-3001-4900	
HYDRAULIC POWER - ATA 29	
5131-BE (base model)	
ICE & RAIN PROTECTION - ATA 30	
09-6200-0010	

BAe (British Aerospace)	
ATP	
LIFTING & SHORING - ATA 7	LANDING GEAR - ATA 32
02-7800C0110 Main (2) 02-1256C0111 Nose 02-7830C0110 Axle 02-7947C0000 03-5808-0000 Wing Stand (2)	14-6801-0120 Z-1063-13 Main (R) Z-1063-16 Nose (R)
TOWING & TAXIING - ATA 9	14-6802-6000 14-6804-6000 14-6805-6010 14-6806-6011 14-6807-6011 14-6808-6000 14-6883-0110 14-6892-6000
01-1202-0000 01-0555-0000 (R) 01-0565-0000 (R) 01-1193-0010 01-1950-5000 01-1954-6000 01-1954-6002 eJP-10 eJP-12 ETT-8X TTR-6 TTR-8	FUSELAGE - ATA 53
PARKING & MOORING - ATA 10	04-6028C0121 K-3057 Crane Hook (R) Z-4082 Lift Tray (R)
99-9028-6000	04-6029-5111 04-6029-5111-A5
SERVICING - ATA 12	04-6152-0120 K-2012 Gooseneck Boom Kit K-2013 Pneumatic Pump Kit K-2953 Hand Winch Kit
ENGINE OIL	
06-5010-6800 06-5022-6800 06-5042-0800	
HYDRAULIC FLUID	
06-4005-3611 06-4035-3600 06-5022-6600 06-5042-3600 06-5043-3600 KHC-1089	
LAVATORY	
10-6402-0010 K-2029 (R) K-2410 (R) 10-6403-6000 10-6412-0000 K-2029 (R) K-2410 (R)	
POTABLE WATER	
19-4305-0000 19-4306-0000 K-2411	
NITROGEN	
18-4201-1010 K-1225 18-4208-0010 18-4303-0000 18-4315-0000 18-4318-0000 PC-1107 K-3706	
OXYGEN	
20-4500-7000 20-4502-6000 20-4504-7000 20-4505-7000 20-4523-0000 20-4525-0000 PC-1124	
ELECTRICAL POWER - ATA 24	
11-4090-0000 11-4290-0000 11-6610-6000	
FUEL - ATA 28	
07-3000-1921 07-3001-4900	
HYDRAULIC POWER - ATA 29	
5211-AB (base model) KHC-1005 KHC-4020	
ICE & RAIN PROTECTION - ATA 30	
09-6200-0010	

BAC I-II
TOWING & TAXIING - ATA 9
01-1124-0000 ETT-12X TTR-12

BAe (British Aerospace)	
146-100/200/300, Avro RJ100	
LIFTING & SHORING - ATA 7	LANDING GEAR - ATA 32
02-2560C0111 Main (2) 02-1256C0111 Tail 02-7830C0110 Axle Main 02-7813C0100 Axle Nose 02-7947C0000	14-6802-6000 14-6804-6000 14-6805-6010 14-6806-6011 14-6807-6011 14-6808-6000 14-6883-0110 14-6892-6000
TOWING & TAXIING - ATA 9	FUSELAGE - ATA 53
01-1161-0009 01-1950-5000 eJP-10 eJP-12 ETT-12X TTR-12	04-6028C0121 K-3057 Crane Hook (R) Z-4082 Lift Tray (R)
PARKING & MOORING - ATA 10	04-6029-5111 04-6029-5111-A5 04-6028C0121 K-3057 Crane Hook (R) Z-4082 Lift Tray (R)
99-9028-6000	POWER PLANT - ATA 71
SERVICING - ATA 12	08-4049-0013
ENGINE OIL	
06-5010-6800 06-5022-6800 06-5042-0800	
HYDRAULIC FLUID	
06-4005-3611 06-4035-3600 06-5022-6600 06-5042-3600 06-5043-3600 KHC-1089	
LAVATORY	
10-4036-0010 K-2410 (R) K-2412 (R) 10-6403-6000 10-6408-0000 K-2410 (R) K-2412 (R) 10-6409-0000	
POTABLE WATER	
19-4301-0000 19-4305-0000 19-4306-0000 K-2411	
NITROGEN	
18-4201-1010 K-1225 18-4208-0010 18-4303-0000 18-4315-0000 18-4318-0000 PC-1107 K-3706	
OXYGEN	
20-4500-7000 20-4502-6000 20-4504-7000 20-4505-7000 20-4523-0000 20-4525-0000 PC-1124 PC-1006 PC-1009	
ELECTRICAL POWER - ATA 24	
11-4090-0000 11-4290-0000 11-6610-6000	
FUEL - ATA 28	
07-3000-1921 07-3006-6900	
HYDRAULIC POWER - ATA 29	
5431-AE (base model) KHC-1008-A KHC-4025	
ICE & RAIN PROTECTION - ATA 30	
09-6200-0010	

For detailed model information reference the items page(s) • Bracketed # = quantity • R = required

BAe (British Aerospace)		BAe (British Aerospace)	
Jetstream 31		Jetstream 41	
LIFTING & SHORING - ATA 7	FUSELAGE - ATA 53	LIFTING & SHORING - ATA 7	LANDING GEAR - ATA 32
02-0536C0110 Main (2) 03-5834-0000 Tripod extension for out-board wing jacking (2) 02-0536C0110 Nose 02-7813C0100 Axle 02-7947C0000 03A5800C0010 Tailstand	04-6028C0121 K-3057 Crane Hook (R) Z-4082 Lift Tray (R) 04-6029-5111 04-6029-5111-A5 04-6152-0120 K-2012 Gooseneck Boom Kit K-2013 Pneumatic Pump Kit K-2953 Hand Winch Kit	02-1036C0111 Main (2) 02-0536C0110 Nose 02-7832C0110 Axle 02-7947C0000 03A5800C0010 Tailstand K-3864	14-6801-0120 Z-1063-13 Main (R) Z-1063-09 Nose (R) 14-6802-6000 14-6804-6000 14-6805-6010 14-6806-6011 14-6807-6011 14-6808-6000 14-6883-0110 14-6892-6000
TOWING & TAXIING - ATA 9	POWER PLANT - ATA 71	TOWING & TAXIING - ATA 9	FUSELAGE - ATA 53
01-1201-0010 01-0526-0000 (R) 01-1954-6000 01-1954-6002 ETT-8X eJP-3 eJP-3L TTR-6 TTR-8	08-0103-4000 08-2023-0010 K-2110 (R) 08-4049-0013 K-1057 (R)	01-1201-0010 01-0575-0011 (R) 01-1215-0000 01-1950-5000 01-1954-6000 01-1954-6002 eJP-3 eJP-3L ETT-8X TTR-6 TTR-8	04-6028C0121 K-3057 Crane Hook (R) Z-4082 Lift Tray (R) 04-6029-5111 04-6029-5111-A5 04-6152-0120 K-2012 Gooseneck Boom Kit K-2013 Pneumatic Pump Kit K-2953 Hand Winch Kit
PARKING & MOORING - ATA 10		PARKING & MOORING - ATA 10	POWER PLANT - ATA 71
99-9028-6000		99-9028-6000	08-0103-4000 08-2023-0010 K-2110 (R) 08-2024-0000 08-4049-0013 K-1057 (R)
SERVICING - ATA 12		SERVICING - ATA 12	
ENGINE OIL		ENGINE OIL	
06-5009C6800 06-5010-6800 06-5022-6800 06-5042-0800		06-5009C6800 06-5010-6800 06-5022-6800 06-5042-0800	
HYDRAULIC FLUID		HYDRAULIC FLUID	
06-4005-0511 06-4035-0500 06-5022-6500 06-5042-0500		06-4005-0511 06-4035-0500 06-5022-6500 06-5042-0500	
NITROGEN		NITROGEN	
18-4201-1010 K-1225 18-4208-0010 18-4303-0000 18-4315-0000 18-4318-0000 PC-1107 K-3706		18-4201-1010 K-1225 18-4208-0010 18-4303-0000 18-4315-0000 18-4318-0000 PC-1107 K-3706	
OXYGEN		OXYGEN	
20-4500-7000 20-4504-7000 20-4505-7000 20-4523-0000 20-4525-0000 PC-1124 PC-1006		20-4500-7000 20-4502-6000 20-4504-7000 20-4505-7000 20-4523-0000 20-4525-0000 PC-1124 PC-1006 PC-1009	
ELECTRICAL POWER - ATA 24		ELECTRICAL POWER - ATA 24	
11-2820-0000 11-6610-6000 112850 112860		11-2820-0000 11-6610-6000 112850 112860	
FUEL - ATA 28		FUEL - ATA 28	
07-3000-1921 07-3006-6900		07-3000-1921 07-3006-6900	
HYDRAULIC POWER - ATA 29		HYDRAULIC POWER - ATA 29	
5110-AA (base model) KHC-1004 KHC-4020		5110-AA (base model) KHC-1004 KHC-4020	
ICE & RAIN PROTECTION - ATA 30		ICE & RAIN PROTECTION - ATA 30	
09-6200-0010		09-6200-0010	
LANDING GEAR - ATA 32		LANDING GEAR - ATA 32	
14-6801-0120 Z-1063-16 Main (R) Z-1063-09 Nose (R) 14-6802-6000 14-6804-6000 14-6805-6010 14-6806-6011 14-6807-6011 14-6808-6000 14-6830-6012 14-6883-0110 14-6892-6000			

BAe (British Aerospace)	
RJ70, RJ85	
LIFTING & SHORING - ATA 7	LANDING GEAR - ATA 32
02-7800C0110 Main (2) G-1206 Ram Nut (R) (RJ70 only) TR-1176 Nut Extension (R) (RJ70 only)	14-6802-6000 14-6804-6000 14-6805-6010 14-6806-6011 14-6807-6011 14-6808-6000 14-6878-0110 14-6883-0110 14-6892-6000
02-7830C0110 Axle Main 02-7813C0100 Axle Nose 02- 1256C0111 Tail 02-7947C0000	
TOWING & TAXIING - ATA 9	FUSELAGE - ATA 53
01-1161-0009 eJP-10 eJP-12 ETT-12X TTR-12	04-6028C0121 K-3057 Crane Hook (R) Z-4082 Lift Tray (R)
PARKING & MOORING - ATA 10	04-6029-5111 04-6029-5111-A5
99-9028-6000	POWER PLANT - ATA 71
SERVICING - ATA 12	08-4049-0013
ENGINE OIL	
06-5010-6800 06-5022-6800 06-5042-0800	
HYDRAULIC FLUID	
06-4005-3611 06-4035-3600 06-5022-6600 06-5042-3600 06-5043-3600 KHC-1089	
LAVATORY	
10-6402-0010 K-2029 (R) K-2410 (R) 10-6403-6000 10-6412-0000 K-2029 (R) K-2410 (R)	
POTABLE WATER	
19-4305-0000 19-4306-0000 K-2411	
NITROGEN	
18-4201-1010 K-1225 18-4208-0010 18-4303-0000 18-4315-0000 18-4318-0000 PC-1107 K-3706	
OXYGEN	
20-4500-7000 20-4504-7000 20-4505-7000 20-4523-0000 20-4525-0000 PC-1124 PC-1006 PC-1009	
ELECTRICAL POWER - ATA 24	
11-6610-6000	
FUEL - ATA 28	
07-3000-1921 07-3006-6900	
HYDRAULIC POWER - ATA 29	
5411-AE (base model) KHC-1008 KHC-4025	
ICE & RAIN PROTECTION - ATA 30	
09-6200-0010	

Beachjet
See Hawker Beechcraft

For detailed model information reference the items page(s) • Bracketed # = quantity • R = required

Bell
204, 205, 212
LIFTING & SHORING - ATA 7
02-0511C0132 Fwd (2) 02A7898C0100 Fwd (2) 02-0511C0132 Aft 02A7898C0100 Aft 02-7947C0000 K-1106
TOWING & TAXIING - ATA 9
TTR-6 (204 only)
SERVICING - ATA 12
ENGINE OIL
06-5009C6800 06-5010-6800 06-5022-6800 06-5042-0800
HYDRAULIC FLUID
06-4005-0511 06-4035-0500 06-5022-6500 06-5042-0500
ELECTRICAL POWER - ATA 24
11-2820-0000 11-6602-1000 11-6610-6000 112850 112860 92-0552-9010
FUEL - ATA 28
07-3000-1921 07-3001-4900 07-3023-0900
HYDRAULIC POWER - ATA 29
204, 212 only: 5010-AB (base model) KHC-1005 KHC-4020
ICE & RAIN PROTECTION - ATA 30
09-4003-4010
FUSELAGE - ATA 53
04-6028C0121 K-3057 Crane Hook (R) 04-6029-5111 04-6029-5111-A5 04-6152-0120 K-2012 Gooseneck Boom Kit K-2013 Pneumatic Pump Kit K-2953 Hand Winch Kit
POWER PLANT - ATA 71
08-4048-1010 K-1152 (R)

Bell
206B3, CH-139, OH-58, TH-67 206L4/LT, 407, 407GX
LIFTING & SHORING - ATA 7
Low Skid Gear: 02-0511C0132 Fwd (2) 02A7898C0100 Fwd (2) 02-0517C0140 Aft
High Skid Gear: 02-0522C0141 Fwd (2) 02-7856C0100 Aft (2) 02-7947C0000
TOWING & TAXIING - ATA 9
TTR-6 (OH-58 only)
SERVICING - ATA 12
ENGINE OIL
06-5009C6800 06-5010-6800 06-5022-6800
HYDRAULIC FLUID
06-4005-0511 06-4035-0500 06-5022-6500 06-5042-0500
ELECTRICAL POWER - ATA 24
11-2820-0000 11-6602-1000 11-6610-6000 112850 112860 92-0552-9010
FUEL - ATA 28
07-3000-1921 07-3006-6900 07-3023-0900
HYDRAULIC POWER - ATA 29
5010-AB (base model) 5221-AB (base model) KHC-1005 KHC-4020
ICE & RAIN PROTECTION - ATA 30
09-4003-4010
FUSELAGE - ATA 53
04-6028C0121 K-3057 Crane Hook (R) Z-4082 Lift Tray (R) 04-6150-0120 K-2012 Gooseneck Boom Kit K-2013 Pneumatic Pump Kit K-2953 Hand Winch Kit
206B3, CH-139, OH-58, TH-67: 04-6029-5111 04-6029-5111-A5
POWER PLANT - ATA 71
08-0104-4000 08-2023-0010 K-2108 (R) 08-4048-1013

Bell
214, 214ST
LIFTING & SHORING - ATA 7
02-0511C0132 Main Skid 02A7898C0100 Main Skid 02-0517C0140 Nose Skid (2) 02-0520C0111 Main Landing Gear (2) 02A7898C0100 Nose Landing Gear 02-7947C0000
TOWING & TAXIING - ATA 9
01-1202-000 01-0535-0000 (R) 01-1150-0000 01-1216-0000 01-1950-5000 01-1954-6000 01-1954-6002
PARKING & MOORING - ATA 10
99-9028-6000
SERVICING - ATA 12
ENGINE OIL
06-5009C6800 06-5010-6800 06-5022-6800
HYDRAULIC FLUID
06-4005-0511 06-4035-0500 06-5022-6500 06-5042-6500
NITROGEN
18-4201-1010 K-1225 18-4208-0010 18-4303-0000 18-4315-0000 18-4318-0000 PC-1107 K-3706
ELECTRICAL POWER - ATA 24
11-2820-0000 11-6602-1000 11-6610-6000 112850 112860 92-0552-9010
FUEL - ATA 28
07-3000-1921 07-3006-6900
HYDRAULIC POWER - ATA 29
5411-AE (base model) KHC-1008 KHC-4025
ICE & RAIN PROTECTION - ATA 30
09-6200-0010
LANDING GEAR - ATA 32
14-6802-6000 14-6804-6000 14-6805-6010 14-6806-6011 14-6807-6011 14-6808-6000 14-6878-0110 14-6883-0110 14-6892-6000
FUSELAGE - ATA 53
04-6028C0121 K-3057 Crane Hook (R) Z-4082 Lift Tray (R) 04-6029-5111 04-6029-5111-A5 04-6152-0120 K-2012 Gooseneck Boom Kit K-2013 Pneumatic Pump Kit K-2953 Hand Winch Kit
POWER PLANT - ATA 71
08-4049-0013

Bell
222, 230
LIFTING & SHORING - ATA 7
02A7898C0100 Nose K-1106 02-0511C0132 Nose 02-0520C0111 Main (2) 02-0520C0111 Main Skid (2) 02-7947C0000
TOWING & TAXIING - ATA 9
01-1202-000 01-0525-0000 (R) 01-1216-0000 01-0525-0000 (R) 01-1134-0006 01-1950-5000 01-1954-6000 01-1954-6002 TTR-6
PARKING & MOORING - ATA 10
99-9028-6000
SERVICING - ATA 12
ENGINE OIL
06-5009C6800 06-5010-6800 06-5022-6800
HYDRAULIC FLUID
06-4005-0511 06-4035-0500 06-5022-6500 06-5042-6500
NITROGEN
18-4201-1010 K-1225 18-4208-0010 18-4303-0000 18-4315-0000 18-4318-0000 PC-1107 K-3706
ELECTRICAL POWER - ATA 24
11-2820-0000 11-6602-1000 11-6610-6000 112850 112860 92-0552-9010
FUEL - ATA 28
07-3000-1921 07-3006-6900 07-3023-0900
HYDRAULIC POWER - ATA 29
5010-AB (base model) KHC-1005 KHC-4020
ICE & RAIN PROTECTION - ATA 30
09-4003-4010
LANDING GEAR - ATA 32
14-6801-0120 Z-1063-09 Main (R) Z-1063-08 Nose (R) 14-6802-6000 14-6804-6000 14-6805-6010 14-6806-6011 14-6807-6011 14-6808-6000 14-6883-0110 14-6892-6000 14-4039-0010
FUSELAGE - ATA 53
04-6028C0121 K-3057 Crane Hook (R) Z-4082 Lift Tray (R) 04-6029-5111 04-6029-5111-A5 04-6152-0120 K-2012 Gooseneck Boom Kit K-2013 Pneumatic Pump Kit K-2953 Hand Winch Kit
POWER PLANT - ATA 71
08-4049-0013 K-2108 (R) Allison 250 K-2111 (R) LTS101 08-0104-4000 08-0105-4000 08-4048-0013

Bell
412
LIFTING & SHORING - ATA 7
02-0511C0132 Forward (2) 02A7898C0100 Forward (2) 02-0511C0132 Aft (2) 02A7898C0100 Aft (2) K-1106 02-7947C0000
TOWING & TAXIING - ATA 9
01-1232-0000 TTR-6
PARKING & MOORING - ATA 10
99-9028-6000
SERVICING - ATA 12
ENGINE OIL
06-5009C6800 06-5010-6800 06-5022-6800
HYDRAULIC FLUID
06-4005-0511 06-4035-0500 06-5022-6500 06-5042-6500
NITROGEN
18-4201-1010 K-1225 18-4208-0010 18-4303-0000 18-4315-0000 18-4318-0000 PC-1107 K-3706
ELECTRICAL POWER - ATA 24
11-2820-0000 11-6602-1000 11-6610-6000 112850 112860 92-0552-9010
FUEL - ATA 28
07-3000-1921 07-3006-6900 07-3023-0900
HYDRAULIC POWER - ATA 29
5010-AB (base model) KHC-1005 KHC-4020
ICE & RAIN PROTECTION - ATA 30
09-4003-4010
FUSELAGE - ATA 53
04-6029-5111 K-3130 04-6029-5111-A5 04-6150-0120 K-2012 Gooseneck Boom Kit K-2013 Pneumatic Pump Kit K-2953 Hand Winch Kit
POWER PLANT - ATA 71
08T4049-0013 K-1152 (R)

Bell
427
LIFTING & SHORING - ATA 7
02-0511C0132 Aft (2) 02A7898C0100 Aft (2) 02-0517C0140 Main (2) 02-0517C0140 Nose 02-7947C0000
High Skid Gear
02-7856C0100 Main (2) 02-7856C0100 Nose
ELECTRICAL POWER - ATA 24
11-2820-0000 112850 112860
FUEL - ATA 28
07-3023-0900
HYDRAULIC POWER - ATA 29
5010-EB_C (base model) KHC-1005 KHC-4020

Bell
429
LIFTING & SHORING - ATA 7
02-0517C0140 Main (2) 02-0517C0140 Nose 02-7947C0000
TOWING & TAXIING - ATA 9
TTR-6
SERVICING - ATA 12
ENGINE OIL
06-5009C6800 06-5010-6800 06-5022-6800
HYDRAULIC FLUID
06-4005-0511 06-4035-0500 06-5022-6500 06-5042-6500
NITROGEN
18-4201-1010 K-1225 18-4208-0010 18-4303-0000 18-4315-0000 18-4318-0000 PC-1107 K-3706
ELECTRICAL POWER - ATA 24
11-2820-0000 112850 112860
FUEL - ATA 28
07-3000-1921 07-3006-6900 07-3023-0900
HYDRAULIC POWER - ATA 29
(base models) 5241-EB_C (60 hz countries) 5441-EB_C (50 hz countries) KHC-1005 KHC-4020
ICE & RAIN PROTECTION - ATA 30
09-4003-4010
LANDING GEAR - ATA 32
14-6801-0120 Z-1063-09 Main (R) Z-1063-08 Nose (R) 14-6802-6000 14-6804-6000 14-6805-6010 14-6806-6011 14-6807-6011 14-6808-6000 14-6883-0110 14-6892-6000 14-4039-0010
FUSELAGE - ATA 53
04-6029-5111 04-6029-5111-A5 04-6150-0120 K-2012 Gooseneck Boom Kit K-2013 Pneumatic Pump Kit K-2953 Hand Winch Kit
POWER PLANT - ATA 71
08-4049-0013 08-4060-6700

Bell
430
LIFTING & SHORING - ATA 7
02A7898C0100 Nose K-1106 02-0511C0132 Nose 02-0520C0111 Main (2) 02-0520C0111 Main Skid (2) 02-7947C0000
TOWING & TAXIING - ATA 9
01-1202-000 01-0525-0000 (R) 01-1216-0000 01-0525-0000 (R) 01-1134-0006 01-1950-5000 01-1954-6000 01-1954-6002
PARKING & MOORING - ATA 10
99-9028-6000
SERVICING - ATA 12
ENGINE OIL
06-5009C6800 06-5010-6800 06-5022-6800
HYDRAULIC FLUID
06-4005-0511 06-4035-0500 06-5022-6500 06-5042-6500
NITROGEN
18-4201-1010 K-1225 18-4208-0010 18-4303-0000 18-4315-0000 18-4318-0000 PC-1107 K-3706
ELECTRICAL POWER - ATA 24
11-2820-0000 11-6602-1000 11-6610-6000 112850 112860 92-0552-9010
FUEL - ATA 28
07-3000-1921 07-3006-6900 07-3023-0900
HYDRAULIC POWER - ATA 29
5010-AB (base model) KHC-1005 KHC-4020
ICE & RAIN PROTECTION - ATA 30
09-4003-4010
LANDING GEAR - ATA 32
14-6801-0120 Z-1063-09 Main (R) Z-1063-08 Nose (R) 14-6802-6000 14-6804-6000 14-6805-6010 14-6806-6011 14-6807-6011 14-6808-6000 14-6883-0110 14-6892-6000 14-4039-0010
FUSELAGE - ATA 53
04-6028C0121 K-3057 Crane Hook (R) Z-4082 Lift Tray (R) 04-6029-5111 04-6029-5111-A5 04-6152-0120 K-2012 Gooseneck Boom Kit K-2013 Pneumatic Pump Kit K-2953 Hand Winch Kit
POWER PLANT - ATA 71
08-4049-0013 K-2108 (R) Allison 250 K-2111 (R) LTS101 08-0104-4000 08-0105-4000 08-4048-0013

For detailed model information reference the items page(s) • Bracketed # = quantity • R = required

Bell
505
LIFTING & SHORING - ATA 7
02-0517C0140 Main (2)
02-0517C0140 Nose
02-7947C0000
SERVICING - ATA 12
ENGINE OIL
06-5009C6800
06-5010-6800
06-5022-6800
HYDRAULIC FLUID
06-4005-0800
06-4035-0800
06-5042-0800
ELECTRICAL POWER - ATA 24
112850
112860
11-2820-0000
11-6644C1010
92-0552-9010
92-0552-9011
FUEL - ATA 28
07-3023-0900
HYDRAULIC POWER - ATA 29
5140 (base model) (60 hz countries)
54241 (base model) (50 hz countries)
ICE & RAIN PROTECTION - ATA 30
09-4003-4010
FUSELAGE - ATA 53
04-6028C0121
K-3057 Crane Hook
Z-4082
04-6150-0120
K-2012 Gooseneck Boom Kit
K-2013 Pneumatic Pump Kit
K-2953 Hand Winch Kit

Bell
525
LIFTING & SHORING - ATA 7
02A7898C0100-A1 (4) (R)
K-4220
02-7861C0100
02-7947C0000
03A5800C0010
TOWING & TAXIING - ATA 9
01-1202-000
01-0616-0000 (R)
01-1216-0000
01-0616-0000 (R)
01-1376-0000
01-1950-5000
01-1954-6000
01-1954-6002
PARKING & MOORING - ATA 10
99-9028-6000
SERVICING - ATA 12
ENGINE OIL
06-5009C6800
06-5010-6800
06-5022-6800
HYDRAULIC FLUID
06-4005-0800
06-4035-0800
06-5042-0800
06-5082-6700
ELECTRICAL POWER - ATA 24
11-2820-0000
11-6644C10100
112850
112860
FUEL - ATA 28
07-3006-6900
07-3023-0900
FUSELAGE - ATA 53
04-6029-5111
04-6029-5111-A5
04-6150-0120
K-2012 Gooseneck Boom Kit
K-2013 Pneumatic Pump Kit
K-2953 Hand Winch Kit

Bell
UH-1, UH-1H
LIFTING & SHORING - ATA 7
02-0511C0130 Fwd (2)
02A7898C0100 Fwd (2)
K-1106
02-0511C0132 Aft
02A7898C0100 Aft (2)
K-1106
02-7947C0000
SERVICING - ATA 12
ENGINE OIL
06-5009C6800
06-5010-6800
06-5022-6800
06-5042-0800
HYDRAULIC FLUID
06-4005-0511
06-4035-0500
06-5022-6500
06-5042-6500
ELECTRICAL POWER - ATA 24
11-2820-0000
11-4090-0000
11-4290-0000
11-6602-1000
11-6610-6000
112850
112860
FUEL - ATA 28
07-3000-1921
07-3001-4900
07-3023-0900
HYDRAULIC POWER - ATA 29
5010-AB (base model)
KHC-1005
KHC-4020
ICE & RAIN PROTECTION - ATA 30
09-4003-4010
FUSELAGE - ATA 53
04-6028C0121
K-3057 Crane Hook (R)
04-6029-5111
04-6029-5111-A5
04-6150-0120
K-2012 Gooseneck Boom Kit
K-2013 Pneumatic Pump Kit
K-2953 Hand Winch Kit
POWER PLANT - ATA 71
08-4048-1012
K-1152

Boeing
707
LIFTING & SHORING - ATA 7
872100A-4 Nose/Fwd 02-7844C0111 Fwd 75900A-2 Main/Wing (2) 02A7850C0100 Main 872200A-6 Tail/Aft 02-7802C0110 Aft 872200A-6 NLG/MLG 02-7947C0000
SERVICING - ATA 12
ENGINE OIL
06-5022-6800 06-5024-3800 06-5043-1800
HYDRAULIC FLUID
06-4005-3611 06-4035-3600 06-5022-6600 06-5024-3610 06-5025-3610 06-5042-3600
POTABLE WATER
19-4301-0000 K-2411
NITROGEN
18-4201-1010 K-1225 18-4208-0010 18-4303-0000 18-4315-0000 18-4318-0000 PC-1107 K-3706
OXYGEN
20-4500-7000 20-4502-6000 20-4504-7000 20-4505-7000 20-4523-0000 20-4525-0000 PC-1124 PC-1006 PC-1009
ELECTRICAL POWER - ATA 24
11-6610-6000
FUEL - ATA 28
07-3000-1921
HYDRAULIC POWER - ATA 29
5431-BC (base model) KHC-1160 KHC-4029
LANDING GEAR - ATA 32
14-6883-0110 K-2965 (R) 14-6802-6000 14-6804-6000 14-6805-6010 14-6806-6011 14-6807-6011 14-6808-6000 14-6878-0110 14-6892-6000 17500M BC400P (R) 17500S-2 BC400P (R)
FUSELAGE - ATA 53
04-6001-1100 04-6030-5111
POWER PLANT - ATA 71
08-4049-0013

Boeing
717
LIFTING & SHORING - ATA 7
71200B-4 Nose/Fwd 02-1032C0111 Fwd 882600-5 Main/Wing (2) 02A7850C0100 Main (2) 721200B-4 Tail/Aft 02-7844C0111 Aft 64200S NLG 83200R-1 MLG 02-7947C0000
TOWING & TAXIING - ATA 9
A005269D A005384D ETT-12X ETT-16 TTR-12
SERVICING - ATA 12
ENGINE OIL
06-5010-6800 06-5022-6800 06-5042-0800
HYDRAULIC FLUID
06-4005-3611 06-4035-3600 06-5025-3610 06-5042-3600 06-5043-3600
LAVATORY
10-6401-0010 K-2029 (R) K-2410 (R) 10-6403-6000 10-6411-0000 K-2029 (R) K-2410 (R)
POTABLE WATER
19-4301-0000 K-2411
NITROGEN
18-4201-1010 K-1225 18-4208-0010 18-4303-0000 18-4315-0000 18-4318-0000 PC-1107 K-3706
OXYGEN
20-4500-7000 20-4502-6000 20-4504-7000 20-4505-7000 20-4523-0000 20-4525-0000 PC-1124 PC-1006 PC-1009
ELECTRICAL POWER - ATA 24
11-4090-0000 11-4290-0000 11-6610-6000
FUEL - ATA 28
07-3000-1921
HYDRAULIC POWER - ATA 29
5431-GE_C (base model) KHC-1160 KHC-4029
LANDING GEAR - ATA 32
14-6883-0110 K-2965 (R) 14-6802-6000 14-6804-6000 14-6805-6010 14-6806-6011 14-6807-6011 14-6808-6000 14-6878-0110 14-6892-6000 17500M BC400P (R) 17500S-2 BC400P (R)
FUSELAGE - ATA 53
04-6001-1100 04-6030-5111
POWER PLANT - ATA 71
08-4044-0010

Boeing
727-100
LIFTING & SHORING - ATA 7
71800B-4 Nose/Fwd 02A2560C0111 Fwd 75900A-2 Main/Wing (2) 02A7850C0100 Main 71800B-2 Tail/Aft 02A7844C0111 Aft 882100-1 NLG/MLG 02-7947C0000
TOWING & TAXIING - ATA 9
A003686D A004190D XM-20 XM-30
SERVICING - ATA 12
ENGINE OIL
06-5022-6800 06-5042-0800 06-5043-1800
HYDRAULIC FLUID
06-4005-3611 06-4035-3600 06-5022-6600 06-5025-3610 06-5042-3600 06-5043-3600 KHC-2014
POTABLE WATER
19-4301-0000 K-2411
NITROGEN
18-4201-1010 K-1225 18-4208-0010 18-4303-0000 18-4315-0000 18-4318-0000 PC-1107 K-3706
OXYGEN
20-4500-7000 20-4502-6000 20-4504-7000 20-4505-7000 20-4523-0000 20-4525-0000 PC-1124 PC-1006 PC-1009
ELECTRICAL POWER - ATA 24
11-4090-0000 11-4290-0000 11-6610-6000
HYDRAULIC POWER - ATA 29
5631-BN (base model)
LANDING GEAR - ATA 32
14-6883-0110 K-2965 (R) 14-6802-6000 14-6804-6000 14-6805-6010 14-6806-6011 14-6807-6011 14-6808-6000 14-6878-0110 14-6892-6000 17500M BC400P (R) 17500S-2 BC400P (R)
FUSELAGE - ATA 53
04-6001-1100 04-6030-5111
POWER PLANT - ATA 71
08-4044-0010

For detailed model information reference the items page(s) • Bracketed # = quantity • R = required

Boeing	
727-200	
LIFTING & SHORING - ATA 7	LANDING GEAR - ATA 32
71800B-4 Nose/Fwd 02A2560C0111 Fwd 75900A-2 Main/Wing (2) 02A7850C0100 Main 71800B-2 Tail/Aft 02A7844C0111 Aft 882100-1 NLG/MLG 02-7947C0000	14-6883-0110 K-2965 (R) 14-6802-6000 14-6804-6000 14-6805-6010 14-6806-6011 14-6807-6011 14-6808-6000 14-6878-0110 14-6892-6000 17500M BC400P (R) 17500S-2 BC400P (R)
TOWING & TAXIING - ATA 9	FUSELAGE - ATA 53
A003686D A004190D XM-20 XM-30	04-6001-1100 04-6029-5111 04-6029-5111-A5
SERVICING - ATA 12	POWER PLANT - ATA 71
ENGINE OIL	08-4044-0010
06-5022-6800 06-5042-0800 06-5043-1800	
HYDRAULIC FLUID	
06-4005-3611 06-4035-3600 06-5022-6600 06-5025-3610 06-5042-3600 06-5043-3600 KHC-2014	
LAVATORY	
10-6401-0010 K-2410 (R) K-2933 (R) K-3606 (R) 10-6403-6000 10-6411-0000 K-2410 (R) K-2933 (R) K-3606 (R)	
POTABLE WATER	
19-4301-0000 K-2411	
NITROGEN	
18-4201-1010 K-1225 18-4208-0010 18-4303-0000 18-4315-0000 18-4318-0000 PC-1107 K-3706	
OXYGEN	
20-4500-7000 20-4502-6000 20-4504-7000 20-4505-7000 20-4523-0000 20-4525-0000 PC-1124 PC-1006 PC-1009	
ELECTRICAL POWER - ATA 24	
11-4090-0000 11-4290-0000 11-6610-6000	
HYDRAULIC POWER - ATA 29	
5731-BN (base model) 673A-FN (base model) KHC-2078	

Boeing	
737-100 thru -500	
LIFTING & SHORING - ATA 7	LANDING GEAR - ATA 32
71400A-8 Nose/Fwd 02A7896C0100 Fwd K-5749 882600-5 Main/Wing (2) 02A7895C0100 Main 71400A-7 Tail/Aft 02A7897C0100 Aft K-2749 83200R-1 NLG 64200S MLG 02-7935C0000 Proof Load Fixture	14-6883-0110 K-2965 (R) 14-6802-6000 14-6804-6000 14-6805-6010 14-6806-6011 14-6807-6011 14-6808-6000 14-6878-0110 14-6892-6000 17500M BC400P (R) 17500S-2 BC400P (R)
TOWING & TAXIING - ATA 9	FUSELAGE - ATA 53
A003819D ETT-12X ETT-16 TTR-12	04-6001-1100 04-6005-1100 04-6030-5111
SERVICING - ATA 12	POWER PLANT - ATA 71
ENGINE OIL	08-4044-0010 K-2248 (R)
06-5022-6800 06-5024-3800 06-5042-0800	
HYDRAULIC FLUID	
06-4005-3611 06-4035-3600 06-5022-6600 06-5025-3610 06-5042-3600 06-5043-3600 KHC-2014	
LAVATORY	
10-6401-0010 K-2410 (R) K-2922 (R) 10-6403-6000 10-6411-0000 K-2410 (R) K-2922 (R)	
POTABLE WATER	
19-4301-0000 K-2411	
NITROGEN	
18-4201-1010 K-1225 18-4208-0010 18-4303-0000 18-4315-0000 18-4318-0000 PC-1107 K-3706	
OXYGEN	
20-4500-7000 20-4502-6000 20-4504-7000 20-4505-7000 20-4523-0000 20-4525-0000 PC-1124 PC-1006 PC-1009	
ELECTRICAL POWER - ATA 24	
11-4090-0000 11-4290-0000 11-6610-6000	
FUEL - ATA 28	
07-3000-1921 07-3001-4900	
HYDRAULIC POWER - ATA 29	
5731-BC (base model) 673A-FC (base model) KHC-1160 KHC-4029	

Boeing	
737-600 thru -900, 737 MAX	
LIFTING & SHORING - ATA 7	LANDING GEAR - ATA 32
71400A-8 Nose/Fwd 02A7896C0100 Fwd K-2749 882600-5 Main/Wing (2) 02A7895C0100 Main 71400A-7 Tail/Aft 02A7897C0100 Aft K-5749 884200-2 NLG/MLG 02-7935C0000 Proof Load Fixture	14-6883-0110 K-2965 (R) 14-6802-6000 14-6804-6000 14-6805-6010 14-6806-6011 14-6807-6011 14-6808-6000 14-6878-0110 14-6892-6000 17500M BC400P (R) 17500S-2 BC400P (R)
TOWING & TAXIING - ATA 9	FUSELAGE - ATA 53
A003819D XM-20 XM-30	04-6001-1100 04-6005-1100 04-6030-5111
SERVICING - ATA 12	POWER PLANT - ATA 71
ENGINE OIL	08-4044-0010 K-2248 (R)
06-5022-6800 06-5024-3800 06-5042-0800 06-5073-0800 KHC-2173	
HYDRAULIC FLUID	
06-4005-3611 06-4035-3600 06-5022-6600 06-5025-3610 06-5042-3600 06-5043-3600 KHC-2014	
LAVATORY	
10-6401-0010 K-2410 (R) K-2922 (R) 10-6403-6000 10-6411-0000 K-2410 (R) K-2922 (R)	
POTABLE WATER	
19-4301-0000 K-2411	
NITROGEN	
18-4201-1010 K-1225 18-4208-0010 18-4303-0000 18-4315-0000 18-4318-0000 PC-1107 K-3706	
OXYGEN	
20-4500-7000 20-4502-6000 20-4504-7000 20-4505-7000 20-4523-0000 20-4525-0000 PC-1124 PC-1006 PC-1009	
ELECTRICAL POWER - ATA 24	
11-4090-0000 11-4290-0000 11-6610-6000	
FUEL - ATA 28	
07-3000-1921 07-3001-4900	
HYDRAULIC POWER - ATA 29	
5731-BC (base model) 673A-FC (base model) KHC-1160 KHC-4029	

Boeing
747
LIFTING & SHORING - ATA 7
73300A-10 Nose/Fwd 881100B-4 Main/Wing (2) 70600A-3 Wing-Tip (2) 891800-2 Tail/Aft 885500-8 NLG/MLG A005386D A004661D (galvanized)
TOWING & TAXIING - ATA 9
A003830D
SERVICING - ATA 12
ENGINE OIL
06-5073-0800 KHC-2173 CSD Fill 06-5022-6800 06-5024-3800 06-5042-0800
HYDRAULIC FLUID
06-4005-3611 06-4035-3600 06-5024-3610 06-5025-3610 06-5043-3600 KHC-1009
POTABLE WATER
19-4301-0000 K-2411
NITROGEN
18-4201-1010 K-1225 18-4208-0010 18-4303-0000 18-4315-0000 18-4318-0000 PC-1107 K-3706
OXYGEN
20-4500-7000 20-4503-6000 20-4504-7000 20-4505-7000 20-4523-0000 20-4525-0000 PC-1124 PC-1006 PC-1009
ELECTRICAL POWER - ATA 24
11-4090-0000 11-4290-0000 11-6610-6000
HYDRAULIC POWER - ATA 29
5833-BJ (base model) KHC-1468
LANDING GEAR - ATA 32
14-6883-0110 K-2965 (R) 17500M BC500P (R) 17500S-2 BC500P (R)
FUSELAGE - ATA 53
04-6001-1100 04-6030-5111

Boeing
747-8
LIFTING & SHORING - ATA 7
73300A-10 Nose/Fwd 881100B-4 Main/Wing (2) 70600A-3 Wing-Tip (2) 885500-8 NLG/MLG
TOWING & TAXIING - ATA 9
A003830D
SERVICING - ATA 12
HYDRAULIC FLUID
06-5025-3610
HYDRAULIC POWER - ATA 29
13-6600-3600 AGE10600D
LANDING GEAR - ATA 32
17500M BC500P (R) 17500S-2 BC500P (R)

For detailed model information reference the items page(s) • Bracketed # = quantity • R = required

Boeing
757
LIFTING & SHORING - ATA 7
73300A-10 Nose/Fwd 881100B-4 Main/Wing (2) R-3541 (R) 872200A-11 Tail/Aft
TOWING & TAXIING - ATA 9
A003813D
SERVICING - ATA 12
ENGINE OIL
06-5010-6800 06-5022-6800 06-5024-3800 06-5042-0800 06-5073-0800 KHC-2173 (R) KHC-2258
HYDRAULIC FLUID
06-4005-3611 06-4035-3600 06-5024-3610 06-5025-3610 06-5043-3600 KHC-1009
POTABLE WATER
19-4301-0000 K-2411
NITROGEN
18-4201-1010 K-1225 18-4208-0010 18-4303-0000 18-4315-0000 18-4318-0000 PC-1107 K-3706
OXYGEN
20-4500-7000 20-4502-6000 20-4504-7000 20-4505-7000 20-4523-0000 20-4525-0000 PC-1124 PC-1006 PC-1009
ELECTRICAL POWER - ATA 24
11-4090-0000 11-4290-0000 11-6610-6000
HYDRAULIC POWER - ATA 29
5833-BJ (base model) KHC-1468
LANDING GEAR - ATA 32
14-6883-0110 K-2965 (R) 14-6878-0110 17500M BC400P (R) 17500S-2 BC400P (R)
FUSELAGE - ATA 53
04-6001-1100 04-6030-5111

Boeing
767
LIFTING & SHORING - ATA 7
73300A-10 Nose/Fwd 881100B-4 Main/Wing (2) 885000-7 Tail/Aft 874600-8 NLG/MLG
TOWING & TAXIING - ATA 9
A212636D
SERVICING - ATA 12
ENGINE OIL
06-5022-6800 06-5024-3800 06-5042-0800 06-5043-1800 06-5073-0800 KHC-2173 KHC-2258 (R)
HYDRAULIC FLUID
06-4005-3611 06-4035-3600 06-5024-3610 06-5025-3610 06-5043-3600 KHC-1009
POTABLE WATER
19-4301-0000 K-2411
NITROGEN
18-4201-1010 K-1225 18-4208-0010 18-4303-0000 18-4315-0000 18-4318-0000 PC-1107 K-3706
OXYGEN
20-4500-7000 20-4502-6000 20-4504-7000 20-4505-7000 20-4523-0000 20-4525-0000 PC-1124 PC-1006 PC-1009
ELECTRICAL POWER - ATA 24
11-4090-0000 11-4290-0000 11-6610-6000
HYDRAULIC POWER - ATA 29
5833-BJ (base model) KHC-1468
LANDING GEAR - ATA 32
14-6802-6000 14-6878-0110 14-6883-0110 K-2965 (R) 14-6892-6000 17500M BC400P (R) 17500S-2 BC400P (R)
FUSELAGE - ATA 53
04-6001-1100 04-6030-5111

Boeing
777
LIFTING & SHORING - ATA 7
881000B-10 Nose/Fwd 881100B-4 Main/Wing (2) 880200-5 Mid-Wing (2) for Shoring & Gear Swing 880300A-3 Wing-Tip (2) 76100-5 Tail/Aft 885500-8 NLG/MLG
TOWING & TAXIING - ATA 9
A212635D A212636D
SERVICING - ATA 12
ENGINE OIL
06-5022-6800 06-5024-3800 06-5042-0800 06-5043-1800 06-5073-0800 KHC-2173 (R)
HYDRAULIC FLUID
06-4005-3611 06-4035-3600 06-5024-3610 06-5025-3610 06-5042-3600 06-5043-3600
POTABLE WATER
19-4301-0000 K-2411
NITROGEN
18-4201-1010 K-1225 18-4208-0010 18-4303-0000 18-4315-0000 18-4318-0000 PC-1107 K-3706
OXYGEN
20-4500-7000 20-4502-6000 20-4504-7000 20-4505-7000 20-4523-0000 20-4525-0000 PC-1124 PC-1006 PC-1009
ELECTRICAL POWER - ATA 24
11-4090-0000 11-4290-0000 11-6610-6000
HYDRAULIC POWER - ATA 29
5833-BJ (base model) KHC-1468
LANDING GEAR - ATA 32
14-6883-0110 K-2965 (R) 14-6878-0110 17500M BC500P (R) 17500S-2 BC500P (R)
FUSELAGE - ATA 53
04-6001-1100 04-6030-5111

Boeing
787
LIFTING & SHORING - ATA 7
73300A-10 Nose/Fwd 881100B-4 Main/Wing (2) 880300A-4 Mid-Wing (2) 880300A-4 Wing-Tip (2) 885000-7 Tail/Aft 874600-8 NLG/MLG
TOWING & TAXIING - ATA 9
A003806D A212636D
SERVICING - ATA 12
COOLANT SERVICE CART
1010A K21016-130 (R) 1011A K21016-130 (R) PF56180 K21016-129 (R)
ENGINE OIL
06-5022-6800 06-5024-3800 06-5042-0800 06-5043-1800 06-5073-0800 KHC-2173 (R)
HYDRAULIC FLUID
06-4005-3611 06-4035-3600 06-5024-3610 06-5025-3610 06-5043-3600 KHC-1009
POTABLE WATER
19-4301-0000 K-2411
NITROGEN
18-4201-1010 K-1225 18-4208-0010 18-4303-0000 18-4315-0000 18-4318-0000 PC-1107 K-3706
OXYGEN
20-4500-7000 20-4502-6000 20-4504-7000 20-4505-7000 20-4523-0000 20-4525-0000 PC-1124 PC-1006 PC-1009
ELECTRICAL POWER - ATA 24
11-4090-0000 11-4290-0000 11-6610-6000
FUEL - ATA 28
07-3000-1921
HYDRAULIC POWER - ATA 29
(base models) 5953-GW (60 Hz countries) 5L53-GW (50 Hz countries) Split System Option C (R) KHC-4010 695A AGE17077B AGE18380
LANDING GEAR - ATA 32
14-6883-0110 K-2965 (R) 14-6878-0110 17500M BC500P (R) 17500S-2 BC500P (R)
FUSELAGE - ATA 53
04-6001-1100 04-6030-5111

Boeing
BBJ, BBJ2
LIFTING & SHORING - ATA 7
02A7895C0100 Main (2) 02A7896C0100 Fwd K-5749 02A7897C0100 Aft 02-7935C0000 Proof Load Fixture
TOWING & TAXIING - ATA 9
01-1392-9000 A003819D XM-20 XM-30
SERVICING - ATA 12
ENGINE OIL
06-5022-6800 06-5024-3800 06-5042-0800 06-5073-0800 KHC-2173
HYDRAULIC FLUID
06-4005-3611 06-4035-3600 06-5022-6600 06-5025-3610 06-5042-3600 06-5043-3600 KHC-2014
LAVATORY
10-6401-0010 K-2410 (R) K-2922 (R) 10-6403-6000 10-6411-0000 K-2410 (R) K-2922 (R)
POTABLE WATER
19-4301-0000 K-2411
NITROGEN
18-4201-1010 K-1225 18-4208-0010 18-4303-0000 18-4315-0000 18-4318-0000 PC-1107 K-3706
OXYGEN
20-4500-7000 20-4502-6000 20-4504-7000 20-4505-7000 20-4523-0000 20-4525-0000 PC-1124 PC-1006 PC-1009
ELECTRICAL POWER - ATA 24
11-4090-0000 11-4290-0000 11-6610-6000
FUEL - ATA 28
07-3000-1921 07-3001-4900
HYDRAULIC POWER - ATA 29
5731-BC (base model) 673A-FC (base model) KHC-1160 KHC-4029
LANDING GEAR - ATA 32
14-6883-0110 K-2965 (R) 14-6802-6000 14-6804-6000 14-6805-6010 14-6806-6011 14-6807-6011 14-6808-6000 14-6878-0110 14-6892-6000
FUSELAGE - ATA 53
04-6001-1100 04-6005-1100 04-6030-5111
POWER PLANT - ATA 71
08-4044-0010 K-2248 (R)

Boeing
DC-8 Series 60
LIFTING & SHORING - ATA 7
71800B-2 Nose/Fwd 75900A-2 Main/Wing (2) 882100-6 MLG 882100-6 NLG 5706789 (R)
TOWING & TAXIING - ATA 9
A003806D
SERVICING - ATA 12
ENGINE OIL
06-5022-6800 06-5024-3800 06-5042-0800
HYDRAULIC FLUID
06-4005-3611 06-4035-3600 06-5022-6600 06-5025-3610 06-5042-3600 06-5043-3600 KHC-2259
LAVATORY
10-6401-0010 K-2029 (R) K-2410 (R) 10-6403-6000 10-6411-0000 K-2029 (R) K-2410 (R)
POTABLE WATER
19-4301-0000 K-2411
NITROGEN
18-4201-1010 K-1225 18-4208-0010 18-4303-0000 18-4315-0000 18-4318-0000 PC-1107 K-3706
OXYGEN
20-4500-7000 20-4502-6000 20-4504-7000 20-4505-7000 20-4523-0000 20-4525-0000 PC-1124 PC-1006 PC-1009
ELECTRICAL POWER - ATA 24
11-4090-0000 11-4290-0000 11-6610-6000
HYDRAULIC POWER - ATA 29
5631-BC (base model) KHC-1160 KHC-4029
LANDING GEAR - ATA 32
14-6883-0110 K-2965 (R) 14-6802-6000 14-6804-6000 14-6805-6010 14-6806-6011 14-6808-6000 14-6830-6012 14-6878-0110 14-6892-6000 17500M BC500P (R) 17500S-2 BC500P (R)
FUSELAGE - ATA 53
04-6001-1100 04-6030-5111
POWER PLANT - ATA 71
08-4048-0013

Boeing
DC-9 Series 10, 20, 30, 33
LIFTING & SHORING - ATA 7
02-1032C0111 Fwd 02-1256C0111 Aft 02-1040C0111 Aft - DC-9 Series 10, 20, 30 02-7844C0111 Aft - DC-9 Series 33 02-7947C0000
TOWING & TAXIING - ATA 9
A005269D A005384D ETT-12X ETT-16 TTR-12
SERVICING - ATA 12
ENGINE OIL
06-5022-6800 06-5024-3800 06-5042-0800
HYDRAULIC FLUID
06-4005-3611 06-4035-3600 06-5022-6600 06-5025-3610 06-5042-3600 06-5043-3600 KHC-1009
LAVATORY
10-6401-0010 K-2029 (R) K-2410 (R) 10-6403-6000 10-6411-0000 K-2029 (R) K-2410 (R)
POTABLE WATER
19-4301-0000 K-2411
NITROGEN
18-4201-1010 K-1225 18-4208-0010 18-4303-0000 18-4315-0000 18-4318-0000 PC-1107 K-3706
OXYGEN
20-4500-7000 20-4502-6000 20-4504-7000 20-4505-7000 20-4523-0000 20-4525-0000 PC-1124 PC-1006 PC-1009
ELECTRICAL POWER - ATA 24
11-4090-0000 11-4290-0000 11-6610-6000
FUEL - ATA 28
07-3000-1921
HYDRAULIC POWER - ATA 29
5431-BC (base model) KHC-1160 KHC-4029
LANDING GEAR - ATA 32
14-6883-0110 K-2965 (R) 14-6802-6000 14-6804-6000 14-6805-6010 14-6806-6011 14-6808-6000 14-6830-6012 14-6878-0110 14-6892-6000 17500M BC500P (R) 17500S-2 BC500P (R)
FUSELAGE - ATA 53
04-6001-1100 04-6030-5111

Boeing
DC-9 Series 40, 50
LIFTING & SHORING - ATA 7
02A7850C0100 Main (2) 02A1032C0111 Fwd 02A7897C0100 Aft K-5749 02A7844C0111 Aft 02-7947C0000
TOWING & TAXIING - ATA 9
A005269D A005384D ETT-12X ETT-16 TTR-12
SERVICING - ATA 12
ENGINE OIL
06-5022-6800 06-5024-3800 06-5042-0800
HYDRAULIC FLUID
06-4005-3611 06-4035-3600 06-5022-6600 06-5025-3610 06-5042-3600 06-5043-3600 KHC-1009
LAVATORY
10-6401-0010 K-2029 (R) K-2410 (R) 10-6403-6000 10-6411-0000 K-2029 (R) K-2410 (R)
POTABLE WATER
19-4301-0000 K-2411
NITROGEN
18-4201-1010 K-1225 18-4208-0010 18-4303-0000 18-4315-0000 18-4318-0000 PC-1107 K-3706
OXYGEN
20-4500-7000 20-4503-6000 20-4504-7000 20-4505-7000 20-4523-0000 20-4525-0000 PC-1124 PC-1006 PC-1009
ELECTRICAL POWER - ATA 24
11-4090-0000 11-4290-0000 11-6610-6000
FUEL - ATA 28
07-3000-1921
HYDRAULIC POWER - ATA 29
5431-BC (base model) KHC-1160 KHC-4029
LANDING GEAR - ATA 32
14-6883-0110 K-2965 (R) 14-6802-6000 14-6804-6000 14-6805-6010 14-6806-6011 14-6808-6000 14-6830-6012 14-6878-0110 14-6892-6000 17500M BC500P (R) 17500S-2 BC500P (R)
FUSELAGE - ATA 53
04-6001-1100 04-6030-5111

For detailed model information reference the items page(s) • Bracketed # = quantity • R = required

Boeing
DC-10 Series 10, 15, 30
LIFTING & SHORING - ATA 7
73300A-10 Nose/Fwd 881100B-7 Main/Wing (2) 879400-8 NLG/MLG
TOWING & TAXIING - ATA 9
A212636D
LANDING GEAR - ATA 32
17500M BC500P (R) 17500S-2 BC500P (R)

KC-46, KC-46A Pegasus
LIFTING & SHORING - ATA 7
881100B-10 Nose 881100B-4 Main/Wing (2) 885000-8 Tail/Aft 2295-10PR Axle 8398-010 Recovery Axle
SERVICING - ATA 12
ENGINE OIL
06-5022-6800 06-5024-3800 06-5042-0800 06-5043-1800 06-5073-0800 KHC-2173 KHC-2258 (R) PF53481-8PWS PW55451-23
HYDRAULIC FLUID
06-4005-3611 06-4035-3600 06-5024-3610 06-5025-3610 06-5043-3600 KHC-1009
POTABLE WATER
19-4301-0000 K-2411
NITROGEN
18-4201-1010 K-1225 18-4208-0010 18-4303-0000 18-4315-0000 18-4318-0000 PC-1107 K-3706
OXYGEN
20-4500-7000 20-4502-6000 20-4504-7000 20-4505-7000 20-4523-0000 20-4525-0000 PC-1124 PC-1006 PC-1009
ELECTRICAL POWER - ATA 24
11-4090-0000 11-4290-0000 11-6610-6000
HYDRAULIC POWER - ATA 29
5833-BJ (base model) KHC-1468
LANDING GEAR - ATA 32
14-6802-6000 14-6878-0110 14-6883-0110 K-2965 (R) 14-6892-6000
FUSELAGE - ATA 53
04-6001-1100 04-6030-5111

Boeing
MD-11
LIFTING & SHORING - ATA 7
881100B-7 Main/Wing (2) 848700A-2 Wing-Tip (2) 879400-8 NLG/MLG
LANDING GEAR - ATA 32
17500M BC500P (R) 17500S-2 BC500P (R)

Boeing
MD-80/90
LIFTING & SHORING - ATA 7
02A7850C0100 Main (2) 02A1032C0111 Fwd 02A7897C0100 Aft K-5749 02A7844C0111 Aft 02-7947C0000
MD-80/90 only:
64200S NLG 75900A-2 Main/Wing (2) 882100-6 MLG 71800B-2 Tail/Aft
TOWING & TAXIING - ATA 9
A005269D A005384D ETT-12X ETT-16 TTR-12
SERVICING - ATA 12
ENGINE OIL
06-5022-6800 06-5024-3800 06-5042-0800
HYDRAULIC FLUID
06-4005-3611 06-4035-3600 06-5022-6600 06-5025-3610 06-5042-3600 06-5043-3600 KHC-1009
LAVATORY
10-6401-0010 K-2029 (R) K-2410 (R) 10-6403-6000 10-6411-0000 K-2029 (R) K-2410 (R)
POTABLE WATER
19-4301-0000 K-2411
NITROGEN
18-4201-1010 K-1225 18-4208-0010 18-4303-0000 18-4315-0000 18-4318-0000 PC-1107 K-3706
OXYGEN
20-4500-7000 20-4503-6000 20-4504-7000 20-4505-7000 20-4523-0000 20-4525-0000 PC-1124 PC-1006 PC-1009
ELECTRICAL POWER - ATA 24
11-4090-0000 11-4290-0000 11-6610-6000
FUEL - ATA 28
07-3000-1921
HYDRAULIC POWER - ATA 29
5431-BC (base model) KHC-1160 KHC-4029
LANDING GEAR - ATA 32
14-6883-0110 K-2965 (R) 14-6802-6000 14-6804-6000 14-6805-6010 14-6806-6011 14-6808-6000 14-6830-6012 14-6878-0110 14-6892-6000 17500M BC500P (R) 17500S-2 BC500P (R)
FUSELAGE - ATA 53
04-6001-1100 04-6030-5111

Boeing
P-8 Poseidon
LIFTING & SHORING - ATA 7
02A7895C0100 Main (2) 02A7896C0100 Fwd K-2749 02A7897C0100 Aft K-5749 02-7935C0000 Proof Load Fixture
TOWING & TAXIING - ATA 9
01-1392-9000 A003819D XM-20 XM-30
SERVICING - ATA 12
ENGINE OIL
06-5022-6800 06-5024-3800 06-5042-0800
HYDRAULIC FLUID
06-4005-3611 06-4035-3600 06-5022-6600 06-5025-3610 06-5042-3600 06-5043-3600 KHC-2014
LAVATORY
10-6401-0010 K-2410 (R) K-2922 (R) 10-6403-6000 10-6411-0000 K-2410 (R) K-2922 (R)
POTABLE WATER
19-4301-0000 K-2411
NITROGEN
18-4201-1010 K-1225 18-4208-0010 18-4303-0000 18-4315-0000 18-4318-0000 PC-1107 K-3706
OXYGEN
20-4500-7000 20-4502-6000 20-4504-7000 20-4505-7000 20-4523-0000 20-4525-0000 PC-1124 PC-1006 PC-1009
FUEL - ATA 28
07-3000-1921 07-3001-4900
HYDRAULIC POWER - ATA 29
5731-BC (base model) 673A-FC (base model) KHC-1160 KHC-4029
LANDING GEAR - ATA 32
14-6883-0110 K-2965 (R) 14-6802-6000 14-6804-6000 14-6805-6010 14-6806-6011 14-6807-6011 14-6808-6000 14-6878-0110 14-6892-6000
FUSELAGE - ATA 53
04-6001-1100 04-6005-1100 04-6030-5111
POWER PLANT - ATA 71
08-4044-0010 K-2248 (R)

Boeing Rotorcraft	
Apache AH-64	
TOWING & TAXIING - ATA 9	
01-1185-0006 01-1185-0011 01-1201-0010-B2 01-0618-0000 (R)	
SERVICING - ATA 12	
HYDRAULIC RESERVOIR FLUID	
06-5022-6500-A7 N-2424-06 (R) N-2559-05 (R)	
ELECTRICAL POWER - ATA 24	
11-4090-0000 11-4290-0000	
HYDRAULIC POWER - ATA 29	
5421-EA_C (base model) KHC-1004 KHC-4020 KHC-4034	

234 Chinook	
LIFTING & SHORING - ATA 7	
02-7809C0110 Main (2) 12314S-1 Main (2) 02-7813C0100 Axle 53D22004 Axle (2) 02-7947C0000	
TOWING & TAXIING - ATA 9	
01-1335-0000 ETT-8X ETT-12X TTR-6 TTR-8	
SERVICING - ATA 12	
HYDRAULIC RESERVOIR FLUID	
06-5022-6500-A7 N-2424-06 (R) N-2559-05 (R)	
ELECTRICAL POWER - ATA 24	
11-4090-0000 11-4290-0000	
HYDRAULIC POWER - ATA 29	
5411-CD (base model) KHC-3744	

CH47, MH47 Chinook	
LIFTING & SHORING - ATA 7	
02-7809C0110 Main (2) 12314S-1 Main (2) 02-7813C0100 Axle 53D22004 Axle (2) 02-7947C0000	
TOWING & TAXIING - ATA 9	
01-1335-0000	
SERVICING - ATA 12	
HYDRAULIC RESERVOIR FLUID	
06-5022-6500-A7 N-2424-06 (R) N-2559-05 (R)	
ELECTRICAL POWER - ATA 24	
11-4090-0000 11-4290-0000	
HYDRAULIC POWER - ATA 29	
5411-CD (base model) KHC-3744 06-5051-6500 K-4972 (R)	

Bombardier (Business)		
Challenger 300, 350		
LIFTING & SHORING - ATA 7		HYDRAULIC POWER - ATA 29
02-1036C0110 Main (2) 02-7856C0100 Nose 02-7863C0100 Axle 02-7947C0000 03A5822-0000 Stabilizing Stand		Pre S/B 100-29-05: 5431-CQ (base model) KHC-3559 Post S/B 100-29-05: 5431-AI (base model) KHC-1011 KHC-1011-M
TOWING & TAXIING - ATA 9		(base models) 54311AI_FKQ4 (60 hz countries) 54311AI_EKQ4 (50 hz countries) KHC-4023 13-6615-6000 AGE17073A 06-5051-6600 K-2340
01-1202-0000 01-0597-0000 (R) 01-1215-0000 01-0597-0000 (R) 01-1296-0000 01-1954-6000 01-1954-6002 ETT-8X ETT-12X TTR-6 TTR-8		ICE & RAIN PROTECTION - ATA 30
PARKING & MOORING - ATA 10		09-6200-0010
99-9015-6000 99-9045-9000		LANDING GEAR - ATA 32
SERVICING - ATA 12		14B6801-0120 Z-1063-17 (R) Z-1064-11 (R) 14-6802-6000 14-6804-6000 14-6805-6010 14-6806-6011 14-6807-6011 14-6808-6000 14-6883-0110 14-6892-6000 14-6898-6000 14-6903-6000 14-6915-0100 14-6918-0600
ENGINE OIL		FUSELAGE - ATA 53
06-5009C6800 06-5022-6800 06-5042-0800		04-6028C0121 Z-4082 Lift Tray (R) 04-6029-5111 04-6029-5111-A5 04-6152-0120 K-2012 Gooseneck Boom Kit K-2013 Pneumatic Pump Kit K-2953 Hand Winch Kit
HYDRAULIC FLUID		POWER PLANT - ATA 71
06-4005-0511 06-4035-0500 06-5004C0500		08-4049-1013
LAVATORY		
10-4036-0010 K-2029 (R) K-2410 (R) 10-6403-6000 10-6408-0000 K-2029 (R) K-2410 (R) 10-6409-0000 10-6408-0000 K-2029 (R) K-2410 (R) 10-6409-0000		
POTABLE WATER		
19-4305-0000 19-4306-0000 K-2411		
NITROGEN		
18-4201-1010 K-1225 18-4208-0010 18-4303-0000 18-4315-0000 18-4318-0000 PC-1107 K-3706		
OXYGEN		
20-4500-7000 20-4502-6000 20-4504-7000 20-4505-7000 20-4523-0000 20-4525-0000 PC-1124		
ELECTRICAL POWER - ATA 24		
11-2820-0000 11-4090-0000 11-4290-0000 11-6610-6000 112850 112860		
FUEL - ATA 28		
07-3000-1921 07-3006-6900		

For detailed model information reference the items page(s) • Bracketed # = quantity • R = required

Bombardier (Business)	
Challenger 600, 601, 604, 650	
LIFTING & SHORING - ATA 7	HYDRAULIC POWER - ATA 29
02-1036C0110 Main (2)	(base models)
02-1032C0111 Nose	5231-AI
02-7813C0100 Axle	52311AI_FKQ4 (60 hz countries)
02-7947C0000	52311AI_EKQ4 (50 hz countries)
03A5800-0010 Stabilizing Stand	KHC-1011
TOWING & TAXIING - ATA 9	KHC-1011-M
01-1202-0000	AGE17073A
01-0550-0000 (R)	13-6615-6000
01-1186-0000	06-5051-6600
01-1196-0010	K-2340
01-1950-5000	ICE & RAIN PROTECTION - ATA 30
01-1954-6000	09-6200-0010
01-1954-6002	LANDING GEAR - ATA 32
ETT-8X	14B6801-0120
ETT-12X	Z-1063-17 (R)
TTR-6	Z-1064-13 (R)
TTR-8	14-6802-6000
PARKING & MOORING - ATA 10	14-6804-6000
99-9028-6000	14-6805-6010
99-9045-9000	14-6806-6011
SERVICING - ATA 12	14-6807-6011
ENGINE OIL	14-6808-6000
06-5009C6800	14-6830-6012
06-5010-6800	14-6883-0110
06-5022-6800	14-6892-6000
06-5042-0800	14-6915-0100
HYDRAULIC FLUID	14-6918-0600
06-4005-3611	18-4216-6000
06-4035-3600	FUSELAGE - ATA 53
06-5022-6600	04-6001-1100
06-5042-3600	04-6028C0121
KHC-1012	K-3057 Crane Hook (R)
KHC-1012-M	Z-4082 Lift Tray (R)
LAVATORY	04-6005-1100
10-4036-0010	04-6029-5111
K-2410 (R)	04-6029-5111-A5
K-2412 (R)	04-6152-0120
10-6408-0000	K-2012 Gooseneck Boom Kit
K-2410 (R)	K-2013 Pneumatic Pump Kit
K-2412 (R)	K-2953 Hand Winch Kit
10-6409-0000	POWER PLANT - ATA 71
POTABLE WATER	08-4049-1013
19-4305-0000	K-1710 (R)
19-4306-0000	
K-2411	
NITROGEN	
18-4201-1010	
K-1225	
18-4208-0010	
18-4303-0000	
18-4315-0000	
18-4318-0000	
PC-1107	
K-3706	
OXYGEN	
20-4500-7000	
20-4502-6000	
20-4504-7000	
20-4505-7000	
20-4523-0000	
20-4525-0000	
PC-1006	
PC-1124	
ELECTRICAL POWER - ATA 24	
11-4090-0000	
11-4290-0000	
11-6610-6000	
FUEL - ATA 28	
07-3000-1921	
07-3006-6900	

Bombardier (Business)	
Challenger 605	
LIFTING & SHORING - ATA 7	LANDING GEAR - ATA 32
02-1036C0110 Main (2)	14B6801-0120
02-1032C0111 Nose	Z-1063-17 (R)
02-7813C0100 Axle	Z-1064-13 (R)
02-7947C0000	14-6802-6000
03A5800-0010 Stabilizing Stand	14-6804-6000
TOWING & TAXIING - ATA 9	14-6805-6010
01-1202-0000	14-6806-6011
01-0550-0000 (R)	14-6807-6011
01-1186-0000	14-6808-6000
01-1196-0010	14-6830-6012
01-1950-5000	14-6883-0110
01-1954-6000	14-6892-6000
01-1954-6002	14-6915-0100
ETT-8X	14-6918-0600
ETT-12X	18-4216-6000
TTR-6	FUSELAGE - ATA 53
TTR-8	04-6001-1100
PARKING & MOORING - ATA 10	04-6028C0121
99-9028-6000	K-3057 Crane Hook (R)
SERVICING - ATA 12	Z-4082 Lift Tray (R)
ENGINE OIL	04-6005-1100
06-5009C6800	04-6029-5111
06-5010-6800	04-6029-5111-A5
06-5022-6800	04-6152-0120
06-5042-0800	K-2012 Gooseneck Boom Kit
HYDRAULIC FLUID	K-2013 Pneumatic Pump Kit
06-4005-3611	K-2953 Hand Winch Kit
06-4035-3600	POWER PLANT - ATA 71
06-5022-6600	08-4049-1013
06-5042-3600	K-1710 (R)
KHC-1012	
KHC-1012-M	
LAVATORY	
10-4036-0010	
K-2410 (R)	
K-2412 (R)	
10-6408-0000	
K-2410 (R)	
K-2412 (R)	
10-6409-0000	
POTABLE WATER	
19-4305-0000	
19-4306-0000	
K-2411	
NITROGEN	
18-4201-1010	
K-1225	
18-4208-0010	
18-4303-0000	
18-4315-0000	
18-4318-0000	
PC-1107	
K-3706	
OXYGEN	
20-4500-7000	
20-4502-6000	
20-4504-7000	
20-4505-7000	
20-4523-0000	
20-4525-0000	
PC-1006	
PC-1124	
ELECTRICAL POWER - ATA 24	
11-6610-6000	
FUEL - ATA 28	
07-3000-1921	
07-3006-6900	
HYDRAULIC POWER - ATA 29	
5231-AI (base model)	
KHC-1011	
KHC-1011-M	
KHC-4023	
AGE17073A	
13-6615-6000	
ICE & RAIN PROTECTION - ATA 30	
09-6200-0010	

Bombardier (Business)	
Challenger 850	
LIFTING & SHORING - ATA 7	HYDRAULIC POWER - ATA 29
02-1036C0110 Main (2) 02-0527C0140 Nose 02-7813C0100 Axle 02-7947C0000 03A5800-0010 Stabilizing Stand	5431-EI_C (base model) 54311EI_CEKQ4 AGE17073A 13-6615-6000 06-5051-6600 K-2340 (R)
TOWING & TAXIING - ATA 9	ICE & RAIN PROTECTION - ATA 30
01-1202-0000 01-0550-0000 (R) 01-1202-0000 01-0550-0000 (R) 01-1202-0000 01-0550-0000 (R) 01-1299-0011 01-1954-6000 01-1954-6002 ETT-8X ETT-12X TTR-6 TTR-8	09-6200-0010 LANDING GEAR - ATA 32
PARKING & MOORING - ATA 10	14B6801-0120 Z-1063-17 (R) Z-1064-13 (R) 14-6802-6000 14-6804-6000 14-6805-6010 14-6806-6011 14-6807-6011 14-6808-6000 14-6883-0110 14-6892-6000 14-6915-0100 14-6918-0600
99-9028-6000	FUSELAGE - ATA 53
SERVICING - ATA 12	04-6001-1100 04-6005-1100 04-6028C0121 Z-4082 Lift Tray (R) 04-6029-5111 04-6029-5111-A5 04-6152-0120 K-2012 Gooseneck Boom Kit K-2013 Pneumatic Pump Kit K-2953 Hand Winch Kit
ENGINE OIL	POWER PLANT - ATA 71
06-5010-6800 06-5022-6800 06-5042-0800 06-5073-0800 KHC-2173 (R)	08-4049-1013 K-1710 (R)
HYDRAULIC FLUID	
06-4005-3611 06-4035-3600 06-5020-3600 06-5022-6600 06-5024-3610 06-5042-3600 KHC-1012 KHC-1012-M	
LAVATORY	
10-6402-0010 K-2029 (R) K-2410 (R) 10-6403-0000 10-6412-0000 K-2029 (R) K-2410 (R)	
POTABLE WATER	
19-4301-0000 K-2411	
NITROGEN	
18-4201-1010 K-1225 18-4208-0010 18-4303-0000 18-4315-0000 18-4318-0000 PC-1107 K-3706	
OXYGEN	
20-4500-7000 20-4502-6000 20-4504-7000 20-4505-7000 20-4523-0000 20-4525-0000 PC-1006 PC-1009 PC-1124	
ELECTRICAL POWER - ATA 24	
11-4090-0000 11-4290-0000 11-6610-6000 112850 112860	
FUEL - ATA 28	
07-3000-1921 07-3006-6900	

Bombardier (Business)	
C-21	
LIFTING & SHORING - ATA 7	FUSELAGE - ATA 53
02-0526C0110 Main (2) 02-0526C0110 Nose 02-7818C0110 Axle 02-7825C0110 Axle 02-7947C0000 03-5824-9000 Stabilizing Stand	04-6000-0910 04-6028C0121 K-3057 Crane Hook (R) 04-6029-5111 04-6029-5111-A5 04-6152-0120 K-2012 Gooseneck Boom Kit K-2013 Pneumatic Pump Kit K-2953 Hand Winch Kit
TOWING & TAXIING - ATA 9	POWER PLANT - ATA 71
01-1202-0000 01-0591-0000 (R) 01-1102-0010 01-1954-6000 01-1954-6002 eJP-3 eJP-3L TTR-6 TTR-8	08-0100-4000 08-0102-4010 08-2001-0000 K-2114 (R) 08-2021C0000 K-1795 (R) 08-2030-0000 K-2770 (R) 08-4049-1013
PARKING & MOORING - ATA 10	
99-9028-6000	
SERVICING - ATA 12	
ENGINE OIL	
06-5009C6800 06-5010-6800 06-5022-6800 06-5042-0800	
HYDRAULIC FLUID	
06-4005-0511 06-4035-0500 06-5022-6500 06-5042-0500 KHC-1139	
NITROGEN	
18-4201-1010 K-1225 18-4208-0010 18-4303-0000 18-4315-0000 18-4318-0000 PC-1107 K-3706	
OXYGEN	
20-4500-7000 20-4502-6000 20-4504-7000 20-4505-7000 20-4523-0000 20-4525-0000 PC-1124 PC-1006	
AIR CONDITIONING - ATA 21	
15_7603-1000 (base model)	
ELECTRICAL POWER - ATA 24	
11-2820-0000 11-6610-6000 112850 112860	
FUEL - ATA 28	
07-3000-1921 07-3006-6900	
HYDRAULIC POWER - ATA 29	
5110-AA (base model) KHC-1004 KHC-4020	
ICE & RAIN PROTECTION - ATA 30	
09-6200-0010	
LANDING GEAR - ATA 32	
14-6801-0120 Z-1063-11 (R) Z-1064-13 (R) 14-6802-6000 14-6804-6000 14-6805-6010 14-6806-6011 14-6807-6011 14-6808-6000 14-6892-6000 14-6896-6000 K-3485 (R) Piston Assemblies 5441003 K-3555 (R) Piston Assemblies 2441107	

CL-215 (CL-215T)
LIFTING & SHORING - ATA 7
02-1040C0110 Main (2) 02-0527C0140 Nose 02-7813C0100 Axle 02-7947C0000
TOWING & TAXIING - ATA 9
01-1201-0000 01-0578-0010 (R) 01-1954-6000 01-1954-6002 ETT-12X TTR-6 TTR-8
ELECTRICAL POWER - ATA 24
11-2820-0000 11-4090-0000 11-4290-0000
HYDRAULIC POWER - ATA 29
5231-AB (base model) KHC-1005 KHC-4020

CL415
LIFTING & SHORING - ATA 7
02-1040C0110 Main (2) 02-0527C0140 Nose 02-7813C0100 Axle 02-7947C0000
TOWING & TAXIING - ATA 9
01-1201-0000 01-0578-0010 (R) 01-1954-6000 01-1954-6002 ETT-12X TTR-6 TTR-8
ELECTRICAL POWER - ATA 24
11-2820-0000 11-4090-0000 11-4290-0000
HYDRAULIC POWER - ATA 29
5421-AB (base model) 5621-AB (base model) KHC-1005 KHC-4020

For detailed model information reference the items page(s) • Bracketed # = quantity • R = required

Bombardier (Business)	
Global 5000, 5500, 6000, 6500, Global Express, Global Express XRS	
LIFTING & SHORING - ATA 7	HYDRAULIC POWER - ATA 29
02A7844C0111 Main (2) 02A1248C0112 Nose 02-7835C0100 Axle Main 02-7813C0100 Axle Nose 02-7935C0000 03A5822C0000 Stabilizing Stand	(base models) 5431-FH 54311FH_CKM4 Split System KHC-1342 KHC-4024 06-5051-6600 K-2340
TOWING & TAXIING - ATA 9	ICE & RAIN PROTECTION - ATA 30
01-1270-0010 01-0801-0010 (R) 01-1290-0100 01-0801-0010 (R) 01-1296-0020 01-1275-0010 01A1275-0020 01-1950-5000 eJP-10 eJP-12 ETT-8X ETT-12X TTR-8 TTR-12	09-6200-0010
PARKING & MOORING - ATA 10	LANDING GEAR - ATA 32
99-9028-6000 99-9045-9000	14-6802-6000 14-6804-6000 14-6805-6010 14-6806-6011 14-6807-6011 14-6808-6000 14-6838-5110 14-6866-6010 14-6878-0110 14-6883-0110 14-6892-6000 14-6909C0000 14-6912-6000
SERVICING - ATA 12	FUSELAGE - ATA 53
ENGINE OIL	04-6001-1100 04-6005-1100 04-6028C0121 Z-4082 Lift Tray (R) 04-6029-5111 04-6029-5111-A5
06-5009C6800 06-5010-6800 06-5022-6800	
HYDRAULIC FLUID	
06-4005-3611 06-4035-3600 06-5022-6600 06-5043-3600 KHC-1012 KHC-1012-M	
LAVATORY	
10-4036-0010 K-2410 (R) K-2412 (R) 10-6403-6000 10-6408-0000 K-2410 (R) K-2412 (R) 10-6409-0000	
POTABLE WATER	
19-4305-0000 19-4306-0000 K-2411	
NITROGEN	
18-4201-1010 K-1225 18-4208-0010 18-4303-0000 18-4315-0000 18-4318-0000 PC-1107 K-3706	
OXYGEN	
20-4500-7000 20-4502-6000 20-4504-7000 20-4505-7000 20-4523-0000 20-4525-0000 PC-1006 PC-1124	
AIR CONDITIONING - ATA 21	
Global Express XRS only: 15_7603-1000 (base model) Global 5000-6500 only: 15_7610-6000 (base model)	
ELECTRICAL POWER - ATA 24	
11-6610-6000	
FUEL - ATA 28	
07-3000-1921 07-3006-6900	

Bombardier (Business)	
Global 7500 (7000), 8000	
LIFTING & SHORING - ATA 7	HYDRAULIC POWER - ATA 29
02A7895C0100-A1 Main (2) 02A7949C0100 Nose 02-7935C0000 02-7926C0100 Axle Main/Nose 02-7835C0100 Axle Main 02-7813C0100 Axle Nose 03A5802C0000 Stabilizing Stand	(base models) 5431-FH 54311FH_CKM4 Split System KHC-1342 KHC-4024 06-5051-6600 K-2340 (R)
TOWING & TAXIING - ATA 9	ICE & RAIN PROTECTION - ATA 30
01-1270-0010 01-0810-0000 (R) 01-1290-0100 01-0810-0000 (R) 01B1365-0000 01-1950-5000 eJP-12 ETT-8X ETT-12X TTR-8 TTR-12	09-6200-0010
PARKING & MOORING - ATA 10	LANDING GEAR - ATA 32
99-9028-6036	14-6802-6000 14-6804-6000 14-6805-6010 14-6806-6011 14-6807-6011 14-6808-6000 14-6830-6012 14-6854-0000 14-6866-6010 14-6878-0110 14-6883-0110 14-6892-6000 14-6909C0000 18-4216-6000
SERVICING - ATA 12	FUSELAGE - ATA 53
ENGINE OIL	04-6001-1100 04-6005-1100 04-6029-5111 04-6029-5111-A5
06-5009C6800 06-5010-6800 06-5022-6800	
HYDRAULIC FLUID	
06-4005-3611 06-4035-3600 06-5021-3600 06-5021-3600-A1 06-5022-6600 06-5042-3600 06-5080-0600 KHC-1012 KHC-1012-M 06-4035-0500 for Landing Gear Strut	
LAVATORY	
10-6402-0010 K-2410 (R) K-2412 (R) 10-6410-0000 K-2410 (R) K-2412 (R)	
POTABLE WATER	
19-4301-0000 19-4303-0000 K-2411	
NITROGEN	
18-4201-1010 K-1225 18-4208-0010 18-4303-0000 18-4315-0000 18-4318-0000 PC-1107 K-3706	
OXYGEN	
20-4500-7000 20-4502-6000 20-4504-7000 20-4505-7000 20-4523-0000 20-4525-0000 PC-1006 PC-1124	
AIR CONDITIONING - ATA 21	
15_7610-6000 (base model)	
ELECTRICAL POWER - ATA 24	
11-6610-6000	
FUEL - ATA 28	
07-3006-6900 07-3006-6900-A1	

Bombardier (Business)	
Learjet 23, 24, 25, 31, 31A, 35, 55	
LIFTING & SHORING - ATA 7	LANDING GEAR - ATA 32
02-0526C0110 Main (2) 02-0526C0110 Nose 02-7818C0110 Axle 02-7825C0110 Axle 02-7947C0000 03A5802C0000 Stabilizing Stand	14-6801-0120 Z-1063-11 (R) Z-1064-13 (R) 14-6802-6000 14-6804-6000 14-6805-6010 14-6806-6011 14-6807-6011 14-6808-6000 14-6892-6000 14-6896-6000 K-3485 (R) Piston Assemblies 5441003 K-3555 (R) Piston Assemblies 2441107
TOWING & TAXIING - ATA 9	FUSELAGE - ATA 53
01-1202-0000 01-0591-0000 (R) 01-1102-0010 01-1954-6000 01-1954-6002 01-1112-0010 (except Learjet 25) eJP-3 eJP-3L ETT-8X TTR-6 TTR-8	04-6000-0910 04-6028C0121 K-3057 Crane Hook (R) 04-6029-5111 04-6029-5111-A5 04-6150-0120 K-2012 Gooseneck Boom Kit K-2013 Pneumatic Pump Kit K-2953 Hand Winch Kit
PARKING & MOORING - ATA 10	POWER PLANT - ATA 71
99-9028-6000 99-9045-9000	08-0100-4000 08-0102-4010 08-2001-0000 K-2114 (R) 08-2021C0000 K-1795 (R) 08-2030-0000 K-2770 (R) 08-4049-1013
SERVICING - ATA 12	
ENGINE OIL	
06-5009C6800 06-5010-6800 06-5022-6800 06-5042-0800	
HYDRAULIC FLUID	
06-4005-0511 06-4035-0500 06-5022-6500 06-5042-0500 KHC-1139	
NITROGEN	
18-4201-1010 K-1225 18-4208-0010 18-4303-0000	
OXYGEN	
20-4500-7000 20-4502-6000 20-4504-7000 20-4505-7000 20-4523-0000 20-4525-0000 PC-1006 PC-1124	
AIR CONDITIONING - ATA 21	
15_7603-1000 (base model) K-1661 (R) - Learjet 23/24/25 K-1286 (R) - Learjet 31/31A/35 K-2182 (R) - Learjet 55, S/N 1 to 124 K-1360 (R) - Learjet 55, S/N 124 & after	
15_7605-1000 (base model) K-1661 (R) - Learjet 23/24/25 K-1286 (R) - Learjet 31/31A/35 K-2182 (R) - Learjet 55, S/N 1 to 124 K-1360 (R) - Learjet 55, S/N 124 & after	
ELECTRICAL POWER - ATA 24	
11-4090-0000 11-4290-0000 11-2820-0000 11-6610-6000 112850 112860	
FUEL - ATA 28	
07-3000-1921 07-3006-6900 H-2598 - Lear 35 only	
HYDRAULIC POWER - ATA 29	
5110-AA (base model) Recommended: 51101AA_FKW KHC-1004 KHC-4020 06-5051-6600 K-4385	
ICE & RAIN PROTECTION - ATA 30	
09-6200-0010	

Bombardier (Business)	
Learjet 45, 70, 75	
LIFTING & SHORING - ATA 7	HYDRAULIC POWER - ATA 29
02-1032C0110 Main (2) 02-0522C0141 Nose 02-7834C0111 Axle 02-7947C0000 03A5809C0000 Stabilizing Stand	(base models) 5211-BV 52111BV_FKQ4 (60 hz countries) 52111BV_EKQ4 (50 hz countries) 06-5051-6600 K-2339 (R)
TOWING & TAXIING - ATA 9	ICE & RAIN PROTECTION - ATA 30
01-1202-0000 01-0591-0000 (R) 01-1102-0010 01-1112-0010 01-1950-5000 01-1954-6000 01-1954-6002 eJP-3 K-5387 (R) eJP-3L K-5387 (R) ETT-8X TTR-6 TTR-8	09-6200-0010 LANDING GEAR - ATA 32
PARKING & MOORING - ATA 10	14-6801-0120 Z-1063-15 (R) Z-1064-13 (R) 14-6802-6000 14-6804-6000 14-6805-6010 14-6806-6011 14-6807-6011 14-6808-6000 14-6890-0100 14-6892-6000
99-9028-6000 99-9045-9000	FUSELAGE - ATA 53
SERVICING - ATA 12	04-6028C0121 K-3057 Crane Hook (R) K-3189 Wing Flap K-4664 APU Lift (R) Lear 45 Z-4082 Lift Tray (R) 04-6029-5111 04-6029-5111-A5 04-6150-0120 K-2012 Gooseneck Boom Kit K-2013 Pneumatic Pump Kit K-2953 Hand Winch Kit
ENGINE OIL	POWER PLANT - ATA 71
06-5009C6800 06-5010-6800 06-5022-6800 06-5042-0800	08-0141-4000 08-2024C0000 K-3215 (R) 08-2030-0000 K-2808 (R) 08-4048-0013
HYDRAULIC FLUID	
06-4005-0511 06-4035-0500 06-5022-6500 06-5042-0500 KHC-2424	
LAVATORY	
10-4036-0010 K-2412 (R) K-2288 (R) 10-6408-0000 K-2412 (R) K-2288 (R) 10-6409-0000	
NITROGEN	
18-4201-1010 K-1225 18-4208-0010 18-4303-0000 18-4315-0000 18-4318-0000 PC-1107 K-3706	
OXYGEN	
20-4500-7000 20-4502-6000 20-4504-7000 20-4505-7000 20-4523-0000 20-4525-0000 PC-1124	
AIR CONDITIONING - ATA 21	
15_7603-1000 (base model) K-1359 (R) K-3357 15_7605-6010 (base model) K-1359 (R)	
ELECTRICAL POWER - ATA 24	
11-2820-0000 11-6610-6000 112850 112860	
FUEL - ATA 28	
07-3000-1921 07-3006-6900	

For detailed model information reference the items page(s) • Bracketed # = quantity • R = required

Bombardier (Business)	
Learjet 60	
LIFTING & SHORING - ATA 7	ICE & RAIN PROTECTION - ATA 30
02-1032C0110 Main (2)	09-6200-0010
02-0520C0111 Nose	LANDING GEAR - ATA 32
02-7818C0110 Axle	14-6801-0120
02-7825C0110 Axle	Z-1063-11 (R)
02-7947C0000	Z-1064-13 (R)
03A5809C0000 Stabilizing Stand	14-6802-6000
TOWING & TAXIING - ATA 9	14-6804-6000
01-1202-0000	14-6805-6010
01-0591-0000 (R)	14-6806-6011
01-1102-0010	14-6807-6011
01-1112-0010	14-6808-6000
01-1950-5000	14-6892-6000
01-1954-6000	14-6896-6000
01-1954-6002	FUSELAGE - ATA 53
eJP-3	04-6028C0121
eJP-3L	K-3057 Crane Hook (R)
ETT-8X	Z-4082 Lift Tray (R)
TTR-6	04-6029-5111
TTR-8	04-6029-5111-A5
PARKING & MOORING - ATA 10	04-6150-0120
99-9028-6000	K-2012 Gooseneck Boom Kit
SERVICING - ATA 12	K-2013 Pneumatic Pump Kit
ENGINE OIL	K-2953 Hand Winch Kit
06-5009C6800	POWER PLANT - ATA 71
06-5010-6800	08-0121-4010
06-5022-6800	K-2809 (R)
06-5042-0800	08-2018-0000
HYDRAULIC FLUID	08-4049-0013
06-4005-0511	
06-4035-0500	
06-5004C0500	
06-5022-6500	
06-5042-0500	
KHC-2424	
LAVATORY	
10-4036-0010	
K-2412 (R)	
K-2288 (R)	
10-6408-0000	
K-2412 (R)	
K-2288 (R)	
10-6409-0000	
NITROGEN	
18-4201-1010	
K-1225	
18-4208-0010	
18-4303-0000	
18-4315-0000	
18-4318-0000	
PC-1107	
K-3706	
OXYGEN	
20-4500-7000	
20-4502-6000	
20-4504-7000	
20-4505-7000	
20-4523-0000	
20-4525-0000	
PC-1006	
PC-1124	
AIR CONDITIONING - ATA 21	
15_7603-1000 (base model)	
K-2182 (R)	
15_7605-6010 (base model)	
K-2182 (R)	
ELECTRICAL POWER - ATA 24	
11-2820-0000	
11-6610-6000	
112850	
112860	
FUEL - ATA 28	
07-3000-1921	
07-3006-6900	
HYDRAULIC POWER - ATA 29	
51100-AA (base model)	
Recommended: 51101AA_FKW	
06-5051-6600	
K-4385 (R)	

Learjet 85
LIFTING & SHORING - ATA 7
02A1036C0111 Main (2)
02-0536C0110 Nose
02-7947C0000
TOWING & TAXIING - ATA 9
01-1202-0000
01-0608-0000 (R)
01-1215-0000
ETT-8X
TTR-6
TTR-8
SERVICING - ATA 12
ENGINE OIL
06-4035-0800
06-5004-0800
06-5009C6800
06-5010-6800
06-5022-6800
HYDRAULIC POWER - ATA 29
5441 (base model)
KHC-4051
POWER PLANT - ATA 71
08-0149C4000
08-2037-0000

Bombardier (Regional)	
Challenger 870, 890	
LIFTING & SHORING - ATA 7	HYDRAULIC POWER - ATA 29
02A7843C0112 Main (2)	5631-EIC (base model)
02A7845C0120 Nose	Recommended: 56311EI_BBC4
02-7854C0110 Axle Main/Nose	KHC-1011
02-7947C0000	KHC-1011-M
03A5828C0000 Stabilizing Stand	KHC-4023
TOWING & TAXIING - ATA 9	AGE17073A
01-1201-0010	13-6615-6000
01-0586-0000 (R)	06-5051-6600
01-1270-0010	K-4388 (R)
01-0803-0000 (R)	LANDING GEAR - ATA 32
01-1290-0100	14-6802-6000
01-0803-0000 (R)	14-6804-6000
01-1281-0010	14-6805-6010
01-1282-0010	14-6806-6011
01-1305-0000	14-6807-6011
01-1951-6000	14-6808-6000
01-1954-6002	14-6878-0110
eJP-10	14-6883-0110
eJP-12	14-6887-8110
ETT-8X	14-6892-6000
ETT-12X	14-6915-0100
TTR-6 - Challenger 870 only	14-6918-0600
TTR-8	FUSELAGE - ATA 53
TTR-12	04-6028C0121
PARKING & MOORING - ATA 10	K-3057 Crane Hook (R)
99-9028-6000	Z-4082 Lift Tray (R)
SERVICING - ATA 12	04-6029-5111
ENGINE OIL	04-6029-5111-A5
06-5010-6800	POWER PLANT - ATA 71
06-5022-6800	08-0137-6000
06-5042-0800	08-4049-0013
06-5073-0800	
KHC-2173 (R)	
HYDRAULIC FLUID	
06-4005-3611	
06-4035-3600	
06-5020-3600	
06-5022-6600	
06-5024-3610	
06-5042-3600	
06-5043-3600	
KHC-1012	
KHC-1012-M	
LAVATORY	
10-6402-0010	
K-2410 (R)	
K-2922 (R)	
10-6403-6000	
10-6412-0000	
K-2410 (R)	
K-2922 (R)	
POTABLE WATER	
19-4301-0000	
K-2411	
NITROGEN	
18-4201-1010	
K-1225	
18-4208-0010	
18-4303-0000	
18-4315-0000	
18-4318-0000	
PC-1107	
K-3706	
OXYGEN	
20-4500-7000	
20-4502-6000	
20-4504-7000	
20-4505-7000	
20-4523-0000	
20-4525-0000	
PC-1006	
PC-1009	
PC-1124	
ELECTRICAL POWER - ATA 24	
11-4090-0000	
11-4290-0000	
11-6610-6000	
FUEL - ATA 28	
07-3000-1921	
07-3006-6900	

Bombardier (Regional)	
CRJ100, CRJ200	
LIFTING & SHORING - ATA 7	HYDRAULIC POWER - ATA 29
02-1036C0111 Main (2) 02-0527C0140 Nose 02-7813C0100 Axle 02-7947C0000 03A5800C0010 Stabilizing Stand	5631-EIC (base model) Recommended: 56311EI_CEQK4 KHC-1011 KHC-1011-M KHC-4023 AGE17073A 13-6615-6000 06-5051-6600 K-2340 (R)
TOWING & TAXIING - ATA 9	LANDING GEAR - ATA 32
01-1201-0010 01-0571-0011 (R) 01-1290-0100 01-0571-0011 (R) 01-1215-0000 01-0571-0011 (R) 01-1229-0011 01-1954-6000 01-1954-6002 eJP-10 eJP-12 ETT-8X TTR-8 TTR-12	14B6801-0120 Z-1063-18 (R) Z-1064-13 (R) 14-6802-6000 14-6804-6000 14-6805-6010 14-6806-6011 14-6807-6011 14-6808-6000 14-6883-0110 14-6892-6000 14-6915-0100 14-6918-0600
PARKING & MOORING - ATA 10	FUSELAGE - ATA 53
99-9028-6000	04-6001-1100 04-6005-1100 04-6028C0121 Z-4082 Lift Tray (R) 04-6029-5111 04-6029-5111-A5 04-6152-0120 K-2012 Gooseneck Boom Kit K-2013 Pneumatic Pump Kit K-2953 Hand Winch Kit
SERVICING - ATA 12	POWER PLANT - ATA 71
ENGINE OIL	08-4049-0013 K-1710 (R)
06-5010-6800 06-5022-6800 06-5042-0800 06-5073-0800 KHC-2173 (R)	
HYDRAULIC FLUID	
06-4005-3611 06-4035-3600 06-5020-3600 06-5022-6600 06-5024-3610 06-5042-3600 06-5043-3600 KHC-1012 KHC-1012-M	
LAVATORY	
10-6402-0010 K-2410 (R) K-2922 (R) 10-6403-6000 10-6412-0000 K-2410 (R) K-2922 (R)	
POTABLE WATER	
19-4301-0000 K-2411	
NITROGEN	
18-4201-1010 K-1225 18-4208-0010 18-4303-0000 18-4315-0000 18-4318-0000 PC-1107 K-3706	
OXYGEN	
20-4500-7000 20-4502-6000 20-4504-7000 20-4505-7000 20-4523-0000 20-4525-0000 PC-1006 PC-1009 PC-1124	
AIR CONDITIONING - ATA 21	
15_7603-1000 (base model)	
ELECTRICAL POWER - ATA 24	
11-4090-0000 11-4290-0000 11-6610-6000 112850 112860	
FUEL - ATA 28	
07-3000-1921 07-3001-4900	

Bombardier (Regional)	
CRJ700, CRJ705, CRJ900, CRJ1000	
LIFTING & SHORING - ATA 7	ELECTRICAL POWER - ATA 24
02A7843C0112 Main (2) 02A7845C0120 Nose 02-7854C0110 Axle Main/Nose 02-7947C0000 03-5825-0110 Stabilizing Stand K-3864	11-4090-0000 11-4290-0000 11-6610-6000
TOWING & TAXIING - ATA 9	FUEL - ATA 28
01-1201-0010 - CRJ700/705 only 01-0586-0000 (R) 01-1270-0010 01-0803-0000 (R) 01-1290-0100 01-0803-0000 (R) 01-1281-0010 01-1282-0010 01-1305-0000 01-1954-6000 01-1954-6002 eJP-10 eJP-12 ETT-8X ETT-12X TTR-6 - CRJ700/705 only TTR-8 TTR-12	07-3000-1921 07-3006-6900
PARKING & MOORING - ATA 10	HYDRAULIC POWER - ATA 29
99-9028-6000	5631-EIC (base model) Recommended: 56311EI_BBC4 KHC-1011 KHC-1011-M KHC-4023 AGE17073A 13-6615-6000 06-5051-6600 K-4388 (R)
SERVICING - ATA 12	LANDING GEAR - ATA 32
ENGINE OIL	14-6802-6000 14-6804-6000 14-6805-6010 14-6806-6011 14-6807-6011 14-6808-6000 14-6878-0110 14-6883-0110 14-6887-8110 14-6892-6000 14-6915-0100 14-6918-0600
06-5010-6800 06-5022-6800 06-5042-0800 06-5073-0800 KHC-2173 (R)	FUSELAGE - ATA 53
HYDRAULIC FLUID	04-6028C0121 K-3057 Crane Hook (R) Z-4082 Lift Tray (R) 04-6029-5111 04-6029-5111-A5
06-4005-3611 06-4035-3600 06-5020-3600 06-5022-6600 06-5024-3610 06-5042-3600 06-5043-3600 KHC-1012 KHC-1012-M	POWER PLANT - ATA 71
LAVATORY	08-0137-6000 08-4049-0013
10-6402-0010 K-2410 (R) K-2922 (R) 10-6412-0000 K-2410 (R) K-2922 (R)	
POTABLE WATER	
19-4301-0000 K-2411	
NITROGEN	
18-4201-1010 K-1225 18-4208-0010 18-4303-0000 18-4315-0000 18-4318-0000 PC-1107 K-3706	
OXYGEN	
20-4500-7000 20-4502-6000 20-4504-7000 20-4505-7000 20-4523-0000 20-4525-0000 PC-1006 PC-1009 PC-1124	

For detailed model information reference the items page(s) • Bracketed # = quantity • R = required

Bombardier (Regional)	
Dash-6 (Twin Otter UV-18A)	
LIFTING & SHORING - ATA 7	
02-0511C0132 Main (2)	
02-0524C0110 Nose	
02-7947C0000	
TOWING & TAXIING - ATA 9	
01-1202-0000	
01-0513-0000 (R)	
01-0544-0000 (R)	
01-1954-6000	
01-1954-6002	
eJP-3	
eJP3L	
ETT-8X	
TTR-6	
TTR-8	
SERVICING - ATA 12	
HYDRAULIC FLUID	
06-5022-6500	
LAVATORY	
10-6402-0010	
10-6412-0000	
POTABLE WATER	
19-4301-0000	
19-4303-0000	
NITROGEN	
18-4208-0010	
18-4303-0000	
18-4315-0000	
18-4318-0000	
PC-1107	
ELECTRICAL POWER - ATA 24	
112850	
112860	
LANDING GEAR - ATA 32	
14-6801-0120	
14-6802-6000	
14-6804-6000	
14-6805-6010	
14-6806-6011	
14-6807-6011	
14-6808-6000	
14-6892-6000	
POWER PLANT - ATA 71	
08-4048-0013	

Bombardier (Regional)	
Dash-7	
LIFTING & SHORING - ATA 7	LANDING GEAR - ATA 32
02-7802C0111 Main (2)	14B6801-0120
02-0522C0141 Nose	Z-3072-20 Main (R)
02-7813C0100 Axle	Z-1063-13 Nose (R)
02-7947C0000	14-6802-6000
03-4012-0000 Stabilizing Stand	14-6804-6000
K-3864	14-6805-6010
TOWING & TAXIING - ATA 9	14-6806-6011
01-1201-0010	14-6807-6011
01-0517-0000 (R)	14-6808-6000
01-1215-0000	14-6883-0110
01-0517-0000 (R)	14-6892-6000
01-1950-5000	FUSELAGE - ATA 53
01-1954-6000	04-6001-1100
01-1954-6002	04-6028C0121
ETT-8X	K-3057 Crane Hook (R)
ETT-12X	Z-4082 Lift Tray (R)
TTR-6	04-6029-5111
TTR-8	04-6029-5111-A5
PARKING & MOORING - ATA 10	04-6150-0120
99-9028-6000	K-2012 Gooseneck Boom Kit
SERVICING - ATA 12	K-2013 Pneumatic Pump Kit
ENGINE OIL	K-2953 Hand Winch Kit
06-5009C6800	PROPELLERS - ATA 61
06-5010-6800	08-4017-0010
06-5022-6800	POWER PLANT - ATA 71
HYDRAULIC FLUID	08-0120-4000
06-4005-3611	08-4048-0013
06-4035-3600	K-1037 (R)
06-5022-6600	
06-5042-3600	
KHC-1014	
LAVATORY	
10-4036-0010	
K-2029 (R)	
K-2410 (R)	
10-6408-0000	
K-2029 (R)	
K-2410 (R)	
10-6409-0000	
POTABLE WATER	
19-4305-0000	
19-4306-0000	
K-2411	
NITROGEN	
18-4201-1010	
K-1225	
18-4208-0010	
18-4303-0000	
18-4315-0000	
18-4318-0000	
PC-1107	
K-3706	
OXYGEN	
20-4500-7000	
20-4502-6000	
20-4504-7000	
20-4505-7000	
20-4523-0000	
20-4525-0000	
PC-1006	
PC-1009	
PC-1124	
ELECTRICAL POWER - ATA 24	
11-2820-0000	
11-6610-6000	
112850	
112860	
FUEL - ATA 28	
07-3000-1921	
07-3006-6900	
HYDRAULIC POWER - ATA 29	
(base models)	
5231-EL_C	
52311EL_BCEKQ4 50 hz countries	
52311EL_BCFKQ4 60 hz countries	
KHC-1013	
06-5051-6600	
K-2340 (R)	
ICE & RAIN PROTECTION - ATA 30	
09-6200-0010	

Bombardier (Regional)	
Dash-8 100/200/300	
LIFTING & SHORING - ATA 7	HYDRAULIC POWER - ATA 29
02-7802C0111 Main (2) R-1117 (2) (R)	5H31-ZZ (base model) KHC-3754
02-0522C0141 Nose R-1117 (2) (R)	06-5051-6600 K-2340 (R)
02-7813C0100 Axle 02-7947C0000	ICE & RAIN PROTECTION - ATA 30
03A5819-0000 - Pre 8/1795 03A5821-0000 - Post 8/1795	09-4003-4010 09-6200-0010
TOWING & TAXIING - ATA 9	LANDING GEAR - ATA 32
01-1201-0010 01-0590-0000 (R)	14B6801-0120
01-1216-0000 01-0590-0000 (R)	Z-1063-16 (R) Main Z-1063-16 (R) Nose Z-1063-16 (R) Nose Hi Floatation
01-1950-5000 01-1954-6000 01-1954-6002	14-6802-6000 14-6804-6000 14-6805-6010 14-6806-6011 14-6807-6011 14-6808-6000 14-6830-6012 14-6874-6000 14-6875-4000 14-6876-4000 14-6883-0110 14-6892-6000 14-6915-0100 99-8098-6000 99-9018-6011
ETT-8X ETT-12X TTR-6 TTR-8 eJP-10 K-4236 (R)	FUSELAGE - ATA 53
PARKING & MOORING - ATA 10	04-6028C0121 K-3057 Crane Hook (R) Z-4082 Lift Tray (R)
99-8133-6000 99-9028-6000	04-6029-5111 04-6029-5111-A5 04-6150-0120 K-2012 Gooseneck Boom Kit K-2013 Pneumatic Pump Kit K-2953 Hand Winch Kit
SERVICING - ATA 12	PROPELLERS - ATA 61
ENGINE OIL	08-0111-6000 08-0115-4000 08-0504-4000 08-0703-6000 08-0704-4000 08-2016-0000
06-5009C6800 06-5010-6800 06-5022-6800	POWER PLANT - ATA 71
HYDRAULIC FLUID	08-0112-4000 08-0113-4000 08-0132-0000 08-2014-0000 08-4048-0013 K-2714 (R)
06-4005-3611 06-4035-3600 06-5022-6600 06-5042-3600 KHC-1012 KHC-1012-M	
LAVATORY	
10-4036-0010 K-2029 (R) K-2410 (R)	
10-6408-0000 K-2029 (R) K-2410 (R)	
10-6409-0000	
POTABLE WATER	
19-4305-0000 19-4306-0000 K-2411	
NITROGEN	
18-4200-1100 K-1225 18-4208-0010 18-4303-0000 18-4315-0000 18-4318-0000 PC-1107 K-3706	
OXYGEN	
20-4500-7000 20-4502-6000 20-4504-7000 20-4505-7000 20-4523-0000 20-4525-0000 PC-1006 PC-1009 PC-1124	
ELECTRICAL POWER - ATA 24	
11-2820-0000 11-4090-0000 11-4290-0000 11-6610-6000 112850 112860	
FUEL - ATA 28	
07-3000-1921 07-3006-6900 07-3008-6900	

Bombardier (Regional)	
Dash-8 Q400	
LIFTING & SHORING - ATA 7	HYDRAULIC POWER - ATA 29
02A7839C0111 Main (2) R-1998 (2) (R)	5631-GG_C (base model) Recommended: 56311GG_BC4 KHC-3754 KHC-4022 06-5051-6600 K-2340 (R)
02A7848C0120 Nose R-1117 (2) (R)	ICE & RAIN PROTECTION - ATA 30
02-7854C0110 Axle 03A5829C0000 Tailstand	09-4003-4010 09-6200-0010
TOWING & TAXIING - ATA 9	LANDING GEAR - ATA 32
01-1201-0010 01-0400-0000 (R)	14-6802-6000 14-6804-6000 14-6805-6010 14-6806-6011 14-6807-6011 14-6808-6000 14-6830-6012 14-6872-8100 K-2734-02 (R) 14-6873-8100 K-2733-02 (R) 14-6878-0100 14-6881-0010 14-6882-6000 14-6882-6010 14-6883-0110 14-6888-6000 14-6889-6000 14-6892-6000 14-6915-0100 99-9018-6011
01-1216-0000 01-0400-0000 (R)	FUSELAGE - ATA 53
eJP-10 K-4235 (R)	04-6000-0910 04-6028C0121 K-3057 Crane Hook (R) 04-0629-5111 04-0629-5111-A5 04-6152-0120 K-2012 Gooseneck Boom Kit K-2013 Pneumatic Pump Kit K-2953 Hand Winch Kit
ETT-8X ETT-12X TTR-6 TTR-8 TTR-12	POWER PLANT - ATA 71
PARKING & MOORING - ATA 10	08-0136-0010 08-4048-0013 K-2714 (R)
99-9028-6000	
SERVICING - ATA 12	
ENGINE OIL	
06-5009C6800 06-5010-6800 06-5022-6800	
HYDRAULIC FLUID	
06-4005-3611 06-4035-3600 06-5022-6600 06-5042-3600 KHC-1012 KHC-1012-M	
HYDRAULIC FLUID - Landing Gear	
06-4005-0511	
LAVATORY	
10-4036-0010 K-2029 (R) K-2410 (R)	
10-6408-0000 K-2029 (R) K-2410 (R)	
10-6409-0000	
POTABLE WATER	
19-4305-0000 19-4306-0000 K-2411	
NITROGEN	
18-4200-1100 K-1225 18-4208-0010 18-4303-0000 18-4315-0000 18-4318-0000 PC-1107 K-3706	
OXYGEN	
20-4500-7000 20-4502-6000 20-4504-7000 20-4505-7000 20-4523-0000 20-4525-0000 PC-1006 PC-1009 PC-1124	
ELECTRICAL POWER - ATA 24	
11-2820-0000 11-4090-0000 11-4290-0000 11-6610-6000 112850 112860	
FUEL - ATA 28	
07-3000-1921 07-3006-6900 07-3008-6900 07-8017-6000 07-8019-4000	

For detailed model information reference the items page(s) • Bracketed # = quantity • R = required

Britten Norman
Islander/Trislander
LIFTING & SHORING - ATA 7
02-0524C0110 Main (2) K-1034 (R) 02-7947C0000
TOWING & TAXIING - ATA 9
01-1201-0010 01-0522-0000 (R) 01-1954-6000 01-1954-6002 eJP-3 ETT-8X TTR-6 TTR-8
ELECTRICAL POWER - ATA 24
11-2820-0000 112850 112860

Cessna
150, 152, 172, 177, 180, 182, 185, 206, 207, 210
LIFTING & SHORING - ATA 7
02-0234-0111 Main (2) 03-5400-0000 Leg Ext. (R) (2) 02-7836C0110 Axle 02-7947C0000 03-4006-0000 Stabilizing Stand
TOWING & TAXIING - ATA 9
01-1233-0010 eJP-3 eJP-3L ETT-8X TTR-6 TTR-8
ELECTRICAL POWER - ATA 24
11-2820-0000
LANDING GEAR - ATA 32
14-6909C0000 14-6911-0100

310, 320, 340, 411, 414, 421
LIFTING & SHORING - ATA 7
02-0234-0111 Main (2) 02-0222C0100 Nose 02-7836C0110 Axle 02-7947C0000
TOWING & TAXIING - ATA 9
01-1202-0000 01-0511-0000 (R) 01-1112-0010 01-1954-6000 01-1954-6001 eJP-3 eJP-3L
310, 320, 340, 421 only: ETT-8X TTR-6 TTR-8
ELECTRICAL POWER - ATA 24
11-2820-0000
LANDING GEAR - ATA 32
14-6909C0000 14-6911-0100

337 Skymaster
LIFTING & SHORING - ATA 7
02-0234-0111 Main (2) 03-5400-0000 Leg Ext. (R) (2) 02-0222C0111 Nose 02-7836C0110 Axle 02-7947C0000
TOWING & TAXIING - ATA 9
01-1112-0010 eJP-3 eJP-3L ETT-8X TTR-6 TTR-8
AIR CONDITIONING - ATA 21
15_7603-1000 (base model) K-1491 (R) 15-7605-6010 K-1491 (R)
ELECTRICAL POWER - ATA 24
11-2820-0000
HYDRAULIC POWER - ATA 29
5010-AR (base model) KHC-1038
LANDING GEAR - ATA 32
14-6909C0000 14-6911-0100

Cessna
401, 404, 414A, 421C
LIFTING & SHORING - ATA 7
02-0526C0110 Main (2) 02-0526C0110 Nose 02-7836C0110 Axle 02-7947C0000
TOWING & TAXIING - ATA 9
01-1202-0000 01-0511-0000 (R) 01-1112-0010 01-1954-6000 01-1954-6001 eJP-3 eJP-3L
404 and 421C only: ETT-8X TTR-6 TTR-8
ELECTRICAL POWER - ATA 24
11-2820-0000
HYDRAULIC POWER - ATA 29
414A only: 5010-AR (base model) KHC-1038
LANDING GEAR - ATA 32
14-6909C0000 14-6911-0100

402
LIFTING & SHORING - ATA 7
02-0526C0110 Main (2) 02-0526C0110 Nose 02-7836C0110 Axle 02-7947C0000
TOWING & TAXIING - ATA 9
01-1202-0000 01-0511-0000 (R) 01-1112-0010 01-1954-6000 01-1954-6001 eJP-3 eJP-3L ETT-8X TTR-6 TTR-8
ELECTRICAL POWER - ATA 24
11-2820-0000 11-6610-6000 112850 112860
LANDING GEAR - ATA 32
14-6801-0120 Z-1063-16 Main (R) Z-1064-11 Nose (R) 14-6909C0000 14-6911-0100
PROPELLERS - ATA 61
08-2033C0000 K-5433 (R)
POWER PLANT - ATA 71
08-0102-4010 08-2001-0000 K-2116 (R) 08-4048-0013 K-1243 (R)

Cessna
408 SkyCourier
LIFTING & SHORING - ATA 7
02-0517C0140 Main (2) 02-7836C0110 Axle 02A5858C0000
TOWING & TAXIING - ATA 9
01-1202-0000 01-0594-0000 (R) 01-1291-0010 01-1292-0000 ETT-8X TTR-6 TTR-8
SERVICING - ATA 12
HYDRAULIC FLUID
06A4035C0800
NITROGEN
18-4208-0010
OXYGEN
20-4500-7000
PROPELLERS - ATA 61
08-2033C0000 K-5433 (R)
LANDING GEAR - ATA 32
14-6801-0120 Z-1063-16 Main (R) Z-1063-11 Nose (R)
POWER PLANT - ATA 71
08-0102-4010 08-2001-0000 K-2116 08-4048-0013 K-1243 (R)

Cessna	
Caravan 208, 208B, 406	
LIFTING & SHORING - ATA 7	
02-7856C0100 Main (2)	
02-0522C0111 Nose	
J-1370 (R) - Caravan 208 only	
02-7836C0110 Axle	
02-7813C0100	
02-7947C0000	
03A5802C0000 Stabilizing Stand	
TOWING & TAXIING - ATA 9	
01-1202-0000	
01-0538-0000 (R)	
01-1170-0010	
01-1954-6000	
01-1954-6002	
eJP-3	
eJP-3L	
ETT-8X	
TTR-6	
TTR-8	
PARKING & MOORING - ATA 10	
99-9028-6000	
SERVICING - ATA 12	
ENGINE OIL	
06-5009C6800	
06-5010-6800	
06-5022-6800	
HYDRAULIC FLUID	
06-4005-3611	
06-4035-3600	
06-5022-6600	
06-5042-3600	
ELECTRICAL POWER - ATA 24	
11-2820-0000	
11-6610-6000	
112850	
112860	
FUEL - ATA 28	
07-3000-1921	
07-3006-6900	
HYDRAULIC POWER - ATA 29	
5010 208/208B only	
5010-DB (base model) - Caravan 406 only	
KHC-4057	
ICE & RAIN PROTECTION - ATA 30	
09-6200-0010	
LANDING GEAR - ATA 32	
14-6801-0120	
Z-1063-13 Main (R)	
Z-1064-11 Nose (R)	
14-6802-6000	
14-6804-6000	
14-6805-6010	
14-6806-6011	
14-6807-6011	
14-6808-6000	
14-6883-0110	
14-6892-6000	
14-6909C0000	
14-6911-0100	
14-4039-0010	
FUSELAGE - ATA 53	
04-6028C0121	
Z-4082 Lift Tray (R)	
04-6029-5111	
04-6029-5111-A5	
04-6150-0120	
K-2012 Gooseneck Boom Kit	
K-2013 Pneumatic Pump Kit	
K-2953 Hand Winch Kit	
POWER PLANT - ATA 71	
08-0100-4000	
08-2001-0000	
K-2115	
08-4048-0013	
K-1243 (R)	

Cessna	
Citation 560XL, 560XLS, Ascend	
LIFTING & SHORING - ATA 7	
02-7815C0100 Main (2)	
R-1798 (R) (2)	
02-7836C0110 Axle	
02-7856C0111 Nose	
R-2008 (R)	
02-7947C0000	
03A5826-0000 Stabilizing Stand	
TOWING & TAXIING - ATA 9	
01-1202-0000	
01-0542-0000 (R)	
01-1291-0010	
01-1292-0000	
01-1299-0000	
01-1950-5000	
01-1954-6000	
01-1954-600E	
eJP-3	
eJP-3L	
ETT-8X	
TTR-6	
TTR-8	
PARKING & MOORING - ATA 10	
99-9028-6000	
SERVICING - ATA 12	
ENGINE OIL	
06-5009C6800	
06-5010-6800	
06-5022-6800	
HYDRAULIC FLUID	
06-4005-3611	
06-4035-3600	
06-5022-6600	
06-5042-3600	
K-4402-02	
LAVATORY	
10-4036-0010	
K-2410 (R)	
K-2412 (R)	
10-6408-0000	
K-2410 (R)	
K-2412 (R)	
10-6409-0000	
POTABLE WATER	
19-4305-0000	
19-4306-0000	
K-2411	
NITROGEN	
18-4201-1010	
K-1225	
18-4208-0010	
18-4303-0000	
18-4315-0000	
18-4318-0000	
PC-1107	
K-3706	
OXYGEN	
20-4500-7000	
20-4502-6000	
20-4504-7000	
20-4505-7000	
20-4523-0000	
20-4525-0000	
PC-1006	
PC-1124	
AIR CONDITIONING - ATA 21	
15 7603-1000 (base model)	
K-2601 (R)	
15-7605-0010 - Citation 560XL only	
K-2601 (R)	
ELECTRICAL POWER - ATA 24	
11-2820-0000	
11-6610-6000	
112850	
112860	
FUEL - ATA 28	
07-3000-1921	
07-3006-6900	
HYDRAULIC POWER - ATA 29	
5130-AH (base model)	
Option "T" (R)	
KHC-1010	
ICE & RAIN PROTECTION - ATA 30	
09-6200-0010	
LANDING GEAR - ATA 32	
14-6801-0120	
Z-1063-15 Main (R)	
Z-1064-13 Nose (R)	
14-6802-6000	
14-6804-6000	
14-6805-6010	
14-6806-6011	
14-6807-6011	
14-6808-6000	
14-6892-6000	
14-6909C0000	
14-6911-0100	
FUSELAGE - ATA 53	
04-6028C0121	
K-3057 Crane Hook (R)	
Z-4082 Lift Tray (R)	
04-6029-5111	
04-6029-5111-A5	
04-6152-0120	
K-2012 Gooseneck Boom Kit	
K-2013 Pneumatic Pump Kit	
K-2953 Hand Winch Kit	
POWER PLANT - ATA 71	
08-2030-0000	
K-2769 (R)	
08-0130-1000	
08-4048-0013	

For detailed model information reference the items page(s) • Bracketed # = quantity • R = required

Cessna	
Citation 650	
LIFTING & SHORING - ATA 7	FUEL - ATA 28
02-1032C0111 Main (2) R-1276 (R) (2)	07-3000-1921 07-3006-6900
02-0526C0110 Nose	ICE & RAIN PROTECTION - ATA 30
02-7813C0100 Axle	09-6200-0010
02-4950-4000 (R)	LANDING GEAR - ATA 32
02-7836C0110 Axle	14-6801-0120
02-7947C0000	Z-1063-15 Main (R)
03A5826-0000 Stabilizing Stand	Z-1064-13 Nose (R)
TOWING & TAXIING - ATA 9	14-6802-6000
01-1202-0000	14-6804-6000
01-0542-0000 (R)	14-6805-6010
01-1291-0010	14-6806-6011
01-1292-0000	14-6807-6011
01-1299-0000	14-6808-6000
01-1950-5000	14-6830-6012
01-1954-6000	14-6892-6000
01-1954-6002	14-6909C0000
eJP-3	14-6911-0100
eJP-3L	FUSELAGE - ATA 53
ETT-8X	04-6001-1100
TTR-6	04-6028C0121
TTR-8	K-3057 Crane Hook (R)
PARKING & MOORING - ATA 10	Z-4082 Lift Tray (R)
99-9028-6000	04-6029-5111
SERVICING - ATA 12	04-6029-5111-A5
ENGINE OIL	04-6152-0120
06-5009C6800	K-2012 Gooseneck Boom Kit
06-5010-6800	K-2013 Pneumatic Pump Kit
06-5022-6800	K-2953 Hand Winch Kit
HYDRAULIC FLUID	POWER PLANT - ATA 71
06-4005-3611	08-0102-4010
06-4035-3600	08-0141-4000
06-5022-6600	08-2021C0000
06-5042-3600	K-1795 (R) TFE 731-1-5
K-4402-02	08-2030-0000
LAVATORY	K-2770 (R) TFE 731-1-5
10-4036-0010	K-2808 (R) TFE 731-20
K-2410 (R)	08-4049-0013
K-2412 (R)	
10-6408-0000	
K-2410 (R)	
K-2412 (R)	
10-6409-0000	
POTABLE WATER	
19-4305-0000	
19-4306-0000	
K-2411	
NITROGEN	
18-4201-1010	
K-1225	
18-4208-0010	
18-4303-0000	
18-4315-0000	
18-4318-0000	
PC-1107	
K-3706	
OXYGEN	
20-4500-7000	
20-4502-6000	
20-4504-7000	
20-4505-7000	
20-4523-0000	
20-4525-0000	
PC-1006	
PC-1124	
AIR CONDITIONING - ATA 21	
15_7603-1000 (base model)	
K-1288 (R)	
15-7605-0010	
K-1288 (R)	
ELECTRICAL POWER - ATA 24	
11-2820-0000	
11-6610-6000	
112850	
112860	

Cessna	
Citation CJ1, CJ2, CJ3, M2	
LIFTING & SHORING - ATA 7	LANDING GEAR - ATA 32
02-0526C0110 Main (2)	14-6801-0120
02-0520C0111 Nose	Z-1063-13 Main (R)
K-3314 (R)	Z-1064-13 Nose (R)
02-7836C0110 Axle	14-6802-6000
02-7947C0000	14-6804-6000
03A5815C0010 Stabilizing Stand	14-6805-6010
TOWING & TAXIING - ATA 9	14-6806-6011
01-1202-0000	14-6807-6011
01-0542-0000 (R)	14-6808-6000
01-0626-0000 (R)	14-6830-6012
01-1101-0000	14-6892-6000
01-1112-0010	14-6909C0000
01-1950-5000	14-6911-0100
01-1954-6000	FUSELAGE - ATA 53
01-1954-6002	04-6028C0121
eJP-3	K-3057 Crane Hook (R)
K-5527 (R) for CJ3 only	Z-4082 Lift Tray (R)
eJP-3L	04-6029-5111
ETT-8X	04-6029-5111-A5
TTR-6	04-6152-0120
TTR-8	K-2012 Gooseneck Boom Kit
PARKING & MOORING - ATA 10	K-2013 Pneumatic Pump Kit
99-9008-6000	K-2953 Hand Winch Kit
99-9028-6000	POWER PLANT - ATA 71
SERVICING - ATA 12	08-0119-8000
ENGINE OIL	08-2021C000
06-5009C6800	K-2032 (R)
06-5010-6800	08-2220C0000
06-5022-6800	08-4048-0013
06-5042-0800	
HYDRAULIC FLUID	
06-4005-3611	
06-4035-3600	
06-5022-6600	
06-5042-3600	
K-4402-01	
NITROGEN	
18-4201-1010	
K-1225	
18-4208-0010	
18-4303-0000	
18-4315-0000	
18-4318-0000	
PC-1107	
K-3706	
OXYGEN	
20-4500-7000	
20-4502-6000	
20-4504-7000	
20-4505-7000	
20-4523-0000	
20-4525-0000	
PC-1006	
PC-1124	
AIR CONDITIONING - ATA 21	
15_7603-1000 (base model)	
K-2601 (R)	
15-7605-0010 - Citation CJ3, M2 only	
K-2601 (R)	
ELECTRICAL POWER - ATA 24	
11-2820-0000	
11-6610-6000	
112850	
112860	
FUEL - ATA 28	
07-3000-1921	
07-3006-6900	
HYDRAULIC POWER - ATA 29	
5F20-BQ (base model)	
KHC-2199	
KHC-4031	
ICE & RAIN PROTECTION - ATA 30	
09-6200-0010	

Cessna
Citation CJ4
LIFTING & SHORING - ATA 7
02-0517C0140 Main (2)
02-0520C0111 Nose K-3314 (R)
02-7836C0110 Axle Cessna supplied adapter (R)
02-7947C0000
03A5815C0010 Stabilizing Stand
TOWING & TAXIING - ATA 9
01-1202-0000
01-0542-0000 (R)
01-0626-0000 (R)
01-1101-0000
01-1954-6000
01-1954-6002
eJP-3 K-5527 (R)
eJP3L
ETT-8X
TTR-6
TTR-8
PARKING & MOORING - ATA 10
99-9028-6000
SERVICING - ATA 12
HYDRAULIC FLUID
06-4035-0800
LAVATORY
10-4036-0010 K-2410 (R) K-2412 (R)
10-6409-0000
POTABLE WATER
19-4305-0000
19-4306-0000
NITROGEN
18-4201-1010 K-1225
18-4208-0010
18-4303-0000
18-4315-0000
18-4318-0000
PC-1107
AIR CONDITIONING - ATA 21
15_7603-1000 (base model) K-1288 (R)
HYDRAULIC POWER - ATA 29
5441-CJ (base model) KHC-3766
LANDING GEAR - ATA 32
14-6801-0120 Z-1063-13 Main (R) Z-1064-11 Nose (R)
FUSELAGE - ATA 53
04-6152-0120 K-2012 Gooseneck Boom Kit K-2013 Pneumatic Pump Kit K-2953 Hand Winch Kit
POWER PLANT - ATA 71
08-0147C4000
08-2021C000 K-4190 (R)
08-4048-0013

Cessna
Citation Encore 560, Ultra 560
LIFTING & SHORING - ATA 7
02-0526C0110 Main (2) R-1798 (R)
02-7836C0110 Axle
02-0520C0111 Nose R-2008 (R)
02-7947C0000
03A4007-0000 Stabilizing Stand
TOWING & TAXIING - ATA 9
01-1202-0000
01-0542-0000 (R)
01-0626-0000 (R)
01-1101-0000
01-1366-0010
01-1954-6000
01-1954-6002
eJP-3
eJP-3L
ETT-8X
TTR-6
TTR-8
PARKING & MOORING - ATA 10
99-4001-0000
99-9028-6000
SERVICING - ATA 12
ENGINE OIL
06-5009C6800
06-5010-6800
06-5022-6800
HYDRAULIC FLUID
06-4005-3611
06-4035-3600
06-5022-6600
06-5042-3600
K-4402-02
HYDRAULIC FLUID - Landing Gear
06-4005-0511
06-4035-0500
NITROGEN
18-4201-1010 K-1225
18-4208-0010
18-4303-0000
18-4315-0000
18-4318-0000
PC-1107
K-3706
OXYGEN
20-4500-7000
20-4502-6000
20-4504-7000
20-4505-7000
20-4523-0000
20-4525-0000
PC-1006
PC-1124
AIR CONDITIONING - ATA 21
15_7603-1000 (base model) K-2601 (R)
15-7605-0010 K-2601 (R)
ELECTRICAL POWER - ATA 24
11-2820-0000
11-6610-6000
112850
112860
FUEL - ATA 28
07-3000-1921
07-3001-4900
HYDRAULIC POWER - ATA 29
5030-AH (base model) Option "T" (R)
KHC-1010
LANDING GEAR - ATA 32
14-6801-0120 Z-1063-13 Main (R) Z-1064-13 Nose (R)
14-6802-6000
14-6805-6010
14-6806-6011
14-6807-6011
14-6808-6000
14-6892-6000
14-6909C0000
14-6911-0100
FUSELAGE - ATA 53
04-6029-5111
04-6029-5111-A5
04-6152-0120 K-2012 Gooseneck Boom Kit K-2013 Pneumatic Pump Kit K-2953 Hand Winch Kit
POWER PLANT - ATA 71
08-0114-4010 K-2478 (R) JT15D-D5
08-0140-4000
08-2021C0000 K-1796 (R) JT15D-D5
08-2030-0000 K-2776 (R) JT15D-D5 K-3068 (R) PW535
08-4048-0013

For detailed model information reference the items page(s) • Bracketed # = quantity • R = required

Cessna	
Citation Latitude 680A	
LIFTING & SHORING - ATA 7	HYDRAULIC POWER - ATA 29
02-7815C0110 Main (2) R-1807 (R)	(base models) 5441-CJ 541CJ9EU4 50 hz countries 541CJ9FU4 60 hz countries KHC-3766 KHC-4021
02-7828C0110 Nose R-1808 (R)	ICE & RAIN PROTECTION - ATA 30
02-7862C0100 Axle	09-6200-0010
02-7836C0110 Axle	LANDING GEAR - ATA 32
02-7947C0000	14-6801-0120
03A5848C0000 Stabilizing Stand	Z-1064-11 Main (R) Z-1064-16 Nose (R)
TOWING & TAXIING - ATA 9	14-6802-6000
01-1202-0000	14-6804-6000
01-0594-0000 (R)	14-6806-6011
01-1291-0010	14-6807-6011
01-1292-0000	14-6808-6000
01-1954-6000	14-6830-6012
01-1954-6002	14-6892-6000
eJP-3	14-6899-6000
eJP-3L	14-6909C0000
ETT-8X	14-6911-0100
TTR-6	FUSELAGE - ATA 53
TTR-8	04-6028C0121
PARKING & MOORING - ATA 10	K-3057 Crane Hook (R) Z-4082 Lift Tray (R)
99-9028-6000	04-6029-5111
SERVICING - ATA 12	04-6029-5111-A5
ENGINE OIL	04-6152-0120
06-5009C6800	K-2012 Gooseneck Boom Kit
06-5010-6800	K-2013 Pneumatic Pump Kit
06-5022-6800	K-2953 Hand Winch Kit
06-5042-0800	POWER PLANT - ATA 71
HYDRAULIC FLUID	08-0143-4000
06-4005-3611	08-2034-0010
06-4035-3600	K-3842 (R)
06-5022-6600	08-4049-0013
06-5042-3600	
K-4402-01	
KHC-3779	
LAVATORY	
10-4036-0010	
K-2410 (R)	
K-2412 (R)	
10-6408-0000	
K-2410 (R)	
K-2412 (R)	
10-6409-0000	
POTABLE WATER	
19-4305-0000	
19-4306-0000	
K-2411	
NITROGEN	
18-4201-1010	
K-1225	
18-4208-0010	
18-4303-0000	
18-4315-0000	
18-4318-0000	
PC-1107	
K-3706	
OXYGEN	
20-4500-7000	
20-4502-6000	
20-4504-7000	
20-4505-7000	
20-4523-0000	
20-4525-0000	
PC-1006	
PC-1124	
AIR CONDITIONING - ATA 21	
15_7603-1000 (base model)	
K-1288 (R)	
15-7605-6010	
K-1288 (R)	
ELECTRICAL POWER - ATA 24	
11-2820-0000	
11-6610-6000	
112850	
112860	
FUEL - ATA 28	
07-3000-1921	
07-3006-6900	

Cessna
Citation Longitude 700
LIFTING & SHORING - ATA 7
02-7815C0110 Main (2) R-3053 (R)
02-7862C0100 Axle
02-7827C0110 Nose R-1808 (R)
02-7836C0110 Axle
03A5853-0000 Stabilizing Stand
TOWING & TAXIING - ATA 9
01-1202-0000
01-0594-0000 (R)
01-1291-0010
01-1292-0000
ETT-8X
TTR-6
TTR-8
PARKING & MOORING - ATA 10
99-9028-6000
SERVICING - ATA 12
HYDRAULIC FLUID
06-4035-3600
LAVATORY
10-4036-0010
K-2410 (R)
K-2412 (R)
POTABLE WATER
19-4305-0000
K-2411
HYDRAULIC POWER - ATA 29
54411GJ 5C (base model)
5441-C Split System (R)
LANDING GEAR - ATA 32
14-6801-0120
Z-1063-16 Main (R)
Z-3064-11 Nose (R)
14-6830-6012

Cessna	
Citation Sovereign 680	
LIFTING & SHORING - ATA 7	HYDRAULIC POWER - ATA 29
02-7815C0100 Main (2) R-1807 (R) (2)	5441-CJ_U (base model) KHC-3766 KHC-4021
02-7827C0110 Nose R-1808 (R)	ICE & RAIN PROTECTION - ATA 30
02-7862C0100 Axle	09-6200-0010
02-7836C0110 Axle	LANDING GEAR - ATA 32
02-7947C0000	14-6801-0120
03A5831-0000 Stabilizing Stand	Z-1064-11 Main (R) Z-1064-16 Nose (R)
TOWING & TAXIING - ATA 9	14-6802-6000
01-1202-0000	14-6804-6000
01-0594-0000 (R)	14-6806-6011
01-1291-0010	14-6807-6011
01-1292-0000	14-6808-6000
01-1954-6000	14-6830-6012
01-1954-6002	14-6892-6000
eJP-3	14-6899-6000
eJP-3L	14-6909C0000
ETT-8X	14-6911-0100
TTR-6	FUSELAGE - ATA 53
TTR-8	04-6028C0121
PARKING & MOORING - ATA 10	K-3057 Crane Hook (R) Z-4082 Lift Tray (R)
99-9028-6000	04-6029-5111
SERVICING - ATA 12	04-6029-5111-A5
ENGINE OIL	04-6152-0120
06-5009C6800	K-2012 Gooseneck Boom Kit
06-5010-6800	K-2013 Pneumatic Pump Kit
06-5022-6800	K-2953 Hand Winch Kit
06-5042-0800	POWER PLANT - ATA 71
HYDRAULIC FLUID	08-0143-4000
06-4005-3611	08-2034-0010
06-4035-3600	K-3842 (R)
06-5022-6600	08-4049-0013
06-5042-3600	
K-4402-01	
KHC-3779	
LAVATORY	
10-4036-0010	
K-2410 (R)	
K-2412 (R)	
10-6408-0000	
K-2410 (R)	
K-2412 (R)	
10-6409-0000	
POTABLE WATER	
19-4305-0000	
19-4306-0000	
K-2411	
NITROGEN	
18-4201-1010	
K-1225	
18-4208-0010	
18-4303-0000	
18-4315-0000	
18-4318-0000	
PC-1107	
K-3706	
OXYGEN	
20-4500-7000	
20-4502-6000	
20-4504-7000	
20-4505-7000	
20-4523-0000	
20-4525-0000	
PC-1006	
PC-1124	
AIR CONDITIONING - ATA 21	
15_7603-1000 (base model)	
K-2601 (R)	
15-7605-6010	
K-2601 (R)	
ELECTRICAL POWER - ATA 24	
11-2820-0000	
11-6610-6000	
112850	
112860	
FUEL - ATA 28	
07-3000-1921	
07-3006-6900	

Cessna	
Citation III, IV, VI, VII	
LIFTING & SHORING - ATA 7	ICE & RAIN PROTECTION - ATA 30
02-1032C0111 Main (2) R-1276 (R) (2)	09-6200-0010
02-0526C0110 Nose	LANDING GEAR - ATA 32
02-7813C0100 Axle	14-6801-0120
02-4950-4000 (R)	Z-1063-15 Main (R) Z-1064-13 Nose (R)
02-7836C0110 Axle	14-6802-6000
02-7947C0000	14-6804-6000
03A5801-0010 Stabilizing Stand	14-6805-6010
TOWING & TAXIING - ATA 9	14-6806-6011
01-1202-0000	14-6807-6011
01-0594-0000 (R)	14-6808-6000
01-1291-0010	14-6830-6012
01-1292-0000	14-6892-6000
01-1950-5000	14-6909C0000
01-1954-6000	14-6911-0100
01-1954-6002	FUSELAGE - ATA 53
eJP-3	04-6001-1100
eJP-3L	04-6028C0121
ETT-8X	K-3057 Crane Hook (R) Z-4082 Lift Tray (R)
TTR-6	04-6029-5111
TTR-8	04-6029-5111-A5
PARKING & MOORING - ATA 10	04-6152-0120
99-9028-6000	K-2012 Gooseneck Boom Kit
SERVICING - ATA 12	K-2013 Pneumatic Pump Kit
ENGINE OIL	K-2953 Hand Winch Kit
06-5009C6800	POWER PLANT - ATA 71
06-5010-6800	08-0102-4010
06-5022-6800	08-0141-4000
06-5042-0800	08-2021C0000
HYDRAULIC FLUID	K-1795 (R) TFE 731-1-5
06-4005-3611	08-2030-0000
06-4035-3600	K-2770 (R) TFE 731-1-5
06-5022-6600	K-2808 (R) TFE 731-20
06-5042-3600	08-4049-0013
K-4402-01	
LAVATORY	
10-4036-0010	
K-2410 (R)	
K-2412 (R)	
10-6408-0000	
K-2410 (R)	
K-2412 (R)	
10-6409-0000	
POTABLE WATER	
19-4305-0000	
19-4306-0000	
K-2411	
NITROGEN	
18-4201-1010	
K-1225	
18-4208-0010	
18-4303-0000	
18-4315-0000	
18-4318-0000	
PC-1107	
K-3706	
OXYGEN	
20-4500-7000	
20-4502-6000	
20-4504-7000	
20-4505-7000	
20-4523-0000	
20-4525-0000	
PC-1006	
PC-1124	
AIR CONDITIONING - ATA 21	
15_7603-1000 (base model)	
K-1288 (R)	
15-7605-0010 - Citation III only	
K-1288 (R)	
ELECTRICAL POWER - ATA 24	
11-2820-0000	
11-6610-6000	
112850	
112860	
FUEL - ATA 28	
07-3000-1921	
07-3006-6900	

For detailed model information reference the items page(s) • Bracketed # = quantity • R = required

Cessna	
Citation I 500, I/SP 501, II 550, SII, V	
LIFTING & SHORING - ATA 7	LANDING GEAR - ATA 32
02-0526C0110 Main (2)	14-6801-0120
02-0520C0111 Nose	Z-1063-13 Main (R)
02-7836C0110 Axle	Z-1064-13 Nose (R)
02-7947C0000	14-6802-6000
03A4007-0000 Stabilizing Stand	14-6804-6000
TOWING & TAXIING - ATA 9	14-6805-6010
01-1202-0000	14-6806-6011
01-0542-0000 (R)	14-6807-6011
01-0626-0000 (R)	14-6808-6000
01-1101-0000	14-6892-6000
01-1112-0010	14-6909C0000
01-1264-0000	14-6911-0100
01-1950-5000	FUSELAGE - ATA 53
01-1954-6000	04-6028C0121
01-1954-6002	K-3057 Crane Hook (R)
eJP-3	Z-4082 Lift Tray (R)
eJP-3L	04-6029-5111
ETT-8X	04-6029-5111-A5
TTR-6	04-6152-0120
TTR-8	K-2012 Gooseneck Boom Kit
PARKING & MOORING - ATA 10	K-2013 Pneumatic Pump Kit
99-4001-0000 - Citation I 500 only	K-2953 Hand Winch Kit
99-9028-6000	POWER PLANT - ATA 71
SERVICING - ATA 12	08-0114-4010
ENGINE OIL	K-2478 (R) -5D
06-5009C6800	08-0130-4000
06-5010-6800	08-2021C0000
06-5022-6800	K-1796 (R) JT15D
HYDRAULIC FLUID	08-2030-0000
06-4005-3611	K-2776 (R) JT15D
06-4035-3600	K-2685 (R) PW530-A
06-5022-6600	08-4048-0013
06-5042-3600	
K-4402-02	
NITROGEN	
18-4201-1010	
K-1225	
18-4208-0010	
18-4303-0000	
18-4315-0000	
18-4318-0000	
PC-1107	
K-3706	
OXYGEN	
20-4500-7000	
20-4502-6000	
20-4504-7000	
20-4505-7000	
20-4523-0000	
20-4525-0000	
PC-1006	
PC-1124	
AIR CONDITIONING - ATA 21	
15_7603-1000 (base model)	
K-2601 (R)	
15-7605-0010	
K-2601 (R)	
ELECTRICAL POWER - ATA 24	
11-2820-0000	
11-6610-6000	
112850	
112860	
FUEL - ATA 28	
07-3000-1921	
07-3007-6900	
HYDRAULIC POWER - ATA 29	
5030-AH (base model)	
Option "T" (R)	
5130-AH (base model)	
Option "T" (R)	
KHC-1010	
ICE & RAIN PROTECTION - ATA 30	
09-6200-0010	

Cessna	
Citation X 750	
LIFTING & SHORING - ATA 7	HYDRAULIC POWER - ATA 29
02-1040C0111 Main (2)	5431-EE_C (base model)
R-1807 (R) (2)	KHC-1008
02-7827C0110 Nose	KHC-4025
R-1808 (R)	ICE & RAIN PROTECTION - ATA 30
02-7833C01010 Axle	09-6200-0010
02-7836C0110 Axle	LANDING GEAR - ATA 32
02-7947C0000	14-6801-0120
03A5817C0000 Stabilizing Stand	Z-1064-11 Main (R)
TOWING & TAXIING - ATA 9	Z-1064-16 Nose (R)
01-1202-0000	14-6802-6000
01-0594-0000 (R)	14-6804-6000
01-1291-0010	14-6807-6011
01-1292-0000	14-6808-6000
01-1950-5000	14-6892-6000
01-1954-6000	14-6899-6000
01-1954-6002	14-6909C0000
ETT-8X	14-6911-0100
TTR-6	FUSELAGE - ATA 53
TTR-8	04-6028C0121
PARKING & MOORING - ATA 10	K-3057 Crane Hook (R)
99-9028-6000	Z-4082 Lift Tray (R)
SERVICING - ATA 12	04-6029-5111
ENGINE OIL	04-6029-5111-A5
06-5009C6800	04-6152-0120
06-5010-6800	K-2012 Gooseneck Boom Kit
06-5022-6800	K-2013 Pneumatic Pump Kit
HYDRAULIC FLUID	K-2953 Hand Winch Kit
06-4005-3611	POWER PLANT - ATA 71
06-4035-3600	08-0129-4000
06-5022-6600	08-2029-0000
06-5042-3600	K-2885
K-4402-02	08-4049-0013
KHC-4012	K-3202 (R)
HYDRAULIC FLUID - Landing Gear	
06-4005-0511	
06-4035-0500	
LAVATORY	
10-4036-0010	
K-2410 (R)	
K-2412 (R)	
10-6408-0000	
K-2410 (R)	
K-2412 (R)	
10-6409-0000	
NITROGEN	
18-4201-1010	
K-1225	
18-4208-0010	
18-4303-0000	
18-4315-0000	
18-4318-0000	
PC-1107	
K-3706	
OXYGEN	
20-4500-7000	
20-4502-6000	
20-4504-7000	
20-4505-7000	
20-4523-0000	
20-4525-0000	
PC-1006	
PC-1124	
AIR CONDITIONING - ATA 21	
15_7603-1000 (base model)	
K-1288 (R)	
K-4031	
15-7605-6010	
K-1288 (R)	
ELECTRICAL POWER - ATA 24	
11-2820-0000	
11-6610-6000	
112850	
112860	
FUEL - ATA 28	
07-3000-1921	
07-3006-6900	

Cessna	
Mustang 510	
LIFTING & SHORING - ATA 7	LANDING GEAR - ATA 32
02-0517C0140 Main (2) R-1798 (R)	14-6801-0120 Z-1063-13 Main (R) Z-1064-13 Nose (R)
02-0517C0140 Nose R-1798 (R)	14-6802-6000
02-7902C0100 Axle	14-6804-6000
02-7836C0110 Axle	14-6805-6010
02-7947C0000	14-6806-6011
03A5815C0000 Stabilizing Stand	14-6807-6011
03-5842C4000 Fly Away Tail Stand	14-6808-6000
	14-6877-6012
TOWING & TAXIING - ATA 9	14-6892-6000
01-1202-0000	14-6909C0000
01-0542-0000 (R)	14-6911-0100
01-0626-0000 (R)	FUSELAGE - ATA 53
01-1101-0000	04-6152-0120
01-1112-0010	K-2012 Gooseneck Boom Kit
01-2004-0000	K-2013 Pneumatic Pump Kit
01-1950-5000	K-2953 Hand Winch Kit
01-1954-6000	POWER PLANT - ATA 71
01-1954-6002	08-0145C4000
eJP-3	K-4000 (R) PW615F-A
eJP-3L	08-2021C0000
ETT-8X	K-3994 (R) PW615F-A
TTR-6	08-4048-0013
TTR-8	
PARKING & MOORING - ATA 10	
99-9008-6000	
99-9028-6000	
SERVICING - ATA 12	
ENGINE OIL	
06-5009C6800	
06-5010-6800	
06-5022-6800	
06-5042-0800	
HYDRAULIC FLUID	
06-4005-3611	
06-4035-3600	
06-5022-6600	
06-5042-3600	
NITROGEN	
18-4201-1010	
K-1225	
18-4208-0010	
18-4303-0000	
18-4315-0000	
18-4318-0000	
PC-1107	
K-3706	
OXYGEN	
20-4500-7000	
20-4502-6000	
20-4504-7000	
20-4505-7000	
20-4523-0000	
20-4525-0000	
PC-1006	
PC-1124	
AIR CONDITIONING - ATA 21	
15_7603-1000 (base model)	
K-2601 (R)	
15-7605-0010	
K-2601 (R)	
ELECTRICAL POWER - ATA 24	
11-2820-0000	
11-6610-6000	
112850	
112860	
FUEL - ATA 28	
07-3000-1921	
07-3001-4900	
ICE & RAIN PROTECTION - ATA 30	
09-6200-0010	

Comac
C909 (ARJ21)
LIFTING & SHORING - ATA 7
718B Main (2)
7215B Nose
02A7867C0100 Axle MLG
02-7861C0100 Axle NLG
TOWING & TAXIING - ATA 9
eJP-12
PARKING & MOORING - ATA 10
99-9028-6000
SERVICING - ATA 12
ENGINE OIL
06-5021-1800
06-5022-6800
06-5042-0800
KHC-2173
HYDRAULIC FLUID
06-4005-0511-A2
06-5009C6600-A1
06-5022-6600-A2
06-5022-6C00-A1
06-5042-3600
KHC-3558
LAVATORY
10-6402-0010
K-2410 (R)
K-2922 (R)
10-6408-0000
K-2410 (R)
K-2922 (R)
POTABLE WATER
19-4305-0000
19-4306-0000
K-2411
NITROGEN
18-4201-1010
K-1225
18-4208-0010
18-4303-0000
K-3706
OXYGEN
20-4500-7000
20-4502-6000
20-4504-7000
20-4505-7000
20-4523-0000
20-4525-0000
PC-1006
PC-1124
ELECTRICAL POWER - ATA 24
11-2820-0000
11-4090-0000
11-4290-0000
11-6610-6000
112850
112860
FUEL - ATA 28
07-3006-6900
07-3014-9900
HYDRAULIC POWER - ATA 29
5731-CQ (base model)
KHC-3559
KHC-6747
KHC-4030
AGE13604A
13-6605-6000
ICE & RAIN PROTECTION - ATA 30
09-4003-4010
09-6200-0010
LANDING GEAR - ATA 32
14-6802-6000
14-6804-6000
14-6805-6010
14-6806-6011
14-6807-6011
14-6808-6000
14-6878-0100
K-3151 (R)
14-6883-0110
K-2965 (R)
POWER PLANT - ATA 71
08-4049-0013

Comac
C919
TOWING & TAXIING - ATA 9
ETT-12X
ETT-16
TTR-12
SERVICING - ATA 12
ENGINE OIL
PF53481-153P
WF174410-72H (150-72H)
HYDRAULIC POWER - ATA 29
AGE19023

For detailed model information reference the items page(s) • Bracketed # = quantity • R = required

Daher Socata
TBM-700, TBM-850
LIFTING & SHORING - ATA 7
02-0222C0111 Main (2)
02-0222C0111 Nose
02-7947C0000
TOWING & TAXIING - ATA 9
01-1233-0010
K-2200 (R)
eJP-3
eJP-3L
ETT-8X
TTR-6
TTR-8

Dassault/Falcon
6X
LIFTING & SHORING - ATA 7
02A7874C0110 Main (2)
02A7874C0110 Nose
02-7835C0100 Axle
K-4296 NLG adapter (R)
TOWING & TAXIING - ATA 9
01-1270-0010
01-0814-0000 (R)
(K-4187 required when used with heavy-duty towbar)
01-1368-0000
eTT-8X
TTR-8
AIR CONDITIONING - ATA 21
15C7610-6000
ELECTRICAL POWER - ATA 24
11-4290-0000
HYDRAULIC POWER - ATA 29
TADHPU-5FJ
LANDING GEAR - ATA 32
14-6920C0700
K-4980
K-4981

Dassault/Falcon
7X, 8X
LIFTING & SHORING - ATA 7
02A7874C0110 Main (2)
02A7874C0110 Nose
7X Main & Nose, 8X Nose:
02-7835C0100 Axle
K-4296 NLG adapter (R)
02-7947C0000
03-5855C0000 Tailstand - 7X only
03A5840C0000 Stabilizing Stand
TOWING & TAXIING - ATA 9
01-1201-0010
01-0602-0000 (R)
01-1329-0000
01-0602-0000 (R)
01-1215-0000
01-0602-0000 (R)
01-1950-5000
01-1954-6000
01-1954-6002
eJP-10
K-5389 (R)
eJP-12
K-5389 (R)
ETT-8X
ETT-12X
TTR-6
TTR-8
TTR-12
PARKING & MOORING - ATA 10
99-9028-6000
99-9045-9000
SERVICING - ATA 12
ENGINE OIL
06-5009C6800
06-5010-6800
06-5022-6800
06-5042-0800
HYDRAULIC FLUID
06-4005-0511
06-4035-0500
06-5022-6500
06-5042-0500
KHC-1339
LAVATORY
10-4036-0010
K-2410 (R)
K-2412 (R)
10-6408-0000
K-2410 (R)
K-2412 (R)
10-6409-0000
POTABLE WATER
19-4305-0000
19-4306-0000
K-2411
NITROGEN
18-4201-1010
K-1225
18-4208-0010
18-4303-0000
18-4315-0000
18-4318-0000
PC-1107
K-3706
OXYGEN
20-4500-7000
20-4502-6000
20-4504-7000
20-4505-7000
20-4523-0000
20-4525-0000
PC-1006
PC-1009
PC-1124
AIR CONDITIONING - ATA 21
15_7610-6000 (base model)
ELECTRICAL POWER - ATA 24
11-2820-0000
11-6610-6000
11-6644C1010
112850
112860
FUEL - ATA 28
07-3000-1921
HYDRAULIC POWER - ATA 29
5J111AA_EKU47 (50 hz countries)
5J111AA_FKU47 (60 hz countries)
KHC-1004
KHC-4091
KHC-4092
AGE17075A
13-6615-6000
KHC-2046
06-5051-6500
K-2339 (R)
K-4387 (R)
ICE & RAIN PROTECTION - ATA 30
09-6200-0010
LANDING GEAR - ATA 32
14B6801-0120
Z-1063-19 Main (R)
Z-1064-08 Nose (R)
14-6802-6000
14-6804-6000
14-6883-0110 - 7X only
14-6805-6010
14-6806-6011
14-6807-6011
14-6808-6000
14-6892-6000
FUSELAGE - ATA 53
04-6028C0121
K-3057 Crane Hook (R)
04-6030-5111
04-6152-0120
K-2012 Gooseneck Boom Kit
K-2013 Pneumatic Pump Kit
K-2953 Hand Winch Kit
POWER PLANT - ATA 71
08-4049-0013

Dassault/Falcon	
10-100	
LIFTING & SHORING - ATA 7	LANDING GEAR - ATA 32
02-7856C0100 Main (2) 027856C0100 Nose 02-7947C0000	14B6801-0120 Z-1063-15 Main (R) Z-1063-17 MAIN (R) Z-1063-11 Nose (R) Z-1064-07 Nose (R) Z-1064-09 Nose (R)
TOWING & TAXIING - ATA 9	14-6802-6000 14-6804-6000 14-6805-6010 14-6806-6011 14-6807-6011 14-6808-6000 14-6883-0110 14-6892-6000
01-1183-0000 01-1202-0000 01-0611-0000 (R) 01-1215-0000 01-0611-0000 (R) 01-1300-0000 01-1950-5000 01-1954-6000 01-1954-6002 eJP-10 ETT-8X ETT-12X TTR-6 TTR-8	FUSELAGE - ATA 53
PARKING & MOORING - ATA 10	04-6028C0121 K-3057 Crane Hook (R) Z-4082 Lift Tray (R)
99-9028-6000 99-9045-9000	04-6029-5111 04-6029-5111-A5 04-6152-0120 K-2012 Gooseneck Boom Kit K-2013 Pneumatic Pump Kit K-2953 Hand Winch Kit
SERVICING - ATA 12	POWER PLANT - ATA 71
ENGINE OIL	08-0102-4010 08-2021C0000 K-1795 (R) 08-2030-0000 K-2770 (R) 08-4049-0013
06-5009C6800 06-5010-6800 06-5022-6800	
HYDRAULIC FLUID	
06-4005-0511 06-4035-0500 06-5022-6500 06-5042-0500	
NITROGEN	
18-4201-1010 K-1225 18-4208-0010 18-4303-0000 18-4315-0000 18-4318-0000 PC-1107 K-3706	
OXYGEN	
20-4500-7000 20-4502-6000 20-4504-7000 20-4505-7000 20-4523-0000 20-4525-0000 PC-1006 PC-1124	
AIR CONDITIONING - ATA 21	
15_7603-1000 (base model) K-1622 (R) 15-7605-6010 K-1622 (R)	
ELECTRICAL POWER - ATA 24	
11-2820-0000 11-6610-6000 112850 112860	
FUEL - ATA 28	
07-3000-1921 07-3006-6900	
HYDRAULIC POWER - ATA 29	
5110-EB_C (base model) Recommended: 51101EB_CFKW KHC-1005 KHC-4020 06-5051-6500 K-4385 (R)	
ICE & RAIN PROTECTION - ATA 30	
09-6200-0010	

Dassault/Falcon	
20-200	
LIFTING & SHORING - ATA 7	LANDING GEAR - ATA 32
02-1036C0111 Main (2) 02-1036C0111 Nose 02-7947C0000	14B6801-0120 Z-1063-17 Main (R) Z-1064-06 Nose (R) Z-1064-09 Nose (R)
TOWING & TAXIING - ATA 9	14-6802-6000 14-6804-6000 14-6805-6010 14-6806-6011 14-6807-6011 14-6808-6000 14-6883-0110 14-6892-6000
01-1200-0000 01-0611-0000 (R) 01-1329-0000 01-0611-0000 (R) 01-1215-0000 01-0611-0000 (R) 01-1183-0000 01-1300-0000 01-1950-5000 01-1954-6000 01-1954-6002 eJP-10 ETT-8X TTR-6 TTR-8	FUSELAGE - ATA 53
PARKING & MOORING - ATA 10	04-6028C0121 K-3057 Crane Hook (R) Z-4082 Lift Tray (R)
99-9028-6000 99-9045-9000	04-6152-0120 K-2012 Gooseneck Boom Kit K-2013 Pneumatic Pump Kit K-2953 Hand Winch Kit
SERVICING - ATA 12	POWER PLANT - ATA 71
ENGINE OIL	08-0100-4000 08-2001-0000 K-2113 (R) 08-4049-0013
06-5009C6800 06-5010-6800 06-5022-6800	
HYDRAULIC FLUID	
06-4005-0511 06-4035-0500 06-5022-6500 06-5042-0500	
NITROGEN	
18-4201-1010 K-1225 18-4208-0010 18-4303-0000 18-4315-0000 18-4318-0000 PC-1107 K-3706	
OXYGEN	
20-4500-7000 20-4502-6000 20-4504-7000 20-4505-7000 20-4523-0000 20-4525-0000 PC-1006 PC-1124	
AIR CONDITIONING - ATA 21	
15_7610-6000 (base model) K-1622 (R) 15-7605-6010 K-1622 (R)	
ELECTRICAL POWER - ATA 24	
11-2820-0000 11-6610-6000 112850 112860	
FUEL - ATA 28	
07-3000-1921 07-3006-6900	
HYDRAULIC POWER - ATA 29	
(base models) 5411-EB_C 54111EB_CEKQ4 50 hz countries 54111EB_CFKQ4 60 hz countries KHC-1005 KHC-4020 06-5051-6500 K-2339 (R)	
ICE & RAIN PROTECTION - ATA 30	
09-6200-0010	

For detailed model information reference the items page(s) • Bracketed # = quantity • R = required

Dassault/Falcon	
50, 50EX	
LIFTING & SHORING - ATA 7	FUEL - ATA 28
02-1040C0111 Main (2)	07-3000-1921
02-1036C0111 Nose	07-3006-6900
02-7947C0000	H-2599 (R)
02-7813C0100 Axle	HYDRAULIC POWER - ATA 29
03A5800C0010 Tailstand	(base models)
TOWING & TAXIING - ATA 9	5411-EB_C
01-1201-0010	54111EB_CEKQ4 50 hz countries
01-0612-0000 (R)	54111EB_CFKQ4 60 hz countries
01-1329-0000	KHC-1005
01-0612-0000 (R)	KHC-4020
01-1215-0000	06-5051-6500
01-0612-0000 (R)	K-2339 (R)
01-1211-0010	ICE & RAIN PROTECTION - ATA 30
01-1950-5000	09-6200-0010
01-1954-6000	LANDING GEAR - ATA 32
01-1954-6002	14B6801-0120
eJP-10	Z-1063-17 Main (R)
K-5388 (R)	Z-1064-06 Nose (R)
eJP-12	Z-1064-09 Nose (R)
K-5388 (R)	14-6802-6000
ETT-8X	14-6804-6000
ETT-12X	14-6805-6010
TTR-6	14-6806-6011
TTR-8	14-6807-6011
PARKING & MOORING - ATA 10	14-6808-6000
99-9028-6000	14-6883-0110
99-9045-9000	14-6892-6000
SERVICING - ATA 12	FUSELAGE - ATA 53
ENGINE OIL	04-6028C0121
06-5009C6800	K-3057 Crane Hook (R)
06-5010-6800	Z-4082 Lift Tray (R)
06-5022-6800	04-6029-5111
HYDRAULIC FLUID	04-6029-5111-A5
06-4005-0511	04-6152-0120
06-4035-0500	K-2012 Gooseneck Boom Kit
06-5022-6500	K-2013 Pneumatic Pump Kit
06-5042-0500	K-2953 Hand Winch Kit
KHC-1339	POWER PLANT - ATA 71
LAVATORY	08-0102-4010 - 50 only
10-4036-0010	08-0142-4000 - 50EX only
K-2410 (R)	08-2021C0000
K-2412 (R)	K-1795 (R) TFE731-3 - 50 only
10-6408-0000	K-3215 (R) TFE731-40 - 50EX only
K-2410 (R)	08-2030C0000
K-2412 (R)	K-2770 (R) TFE731-3 - 50 only
10-6409-0000	K-2108 (R) TFE731-40 - 50EX only
POTABLE WATER	08-4049-0013
19-4305-0000	
19-4306-0000	
K-2411	
NITROGEN	
18-4201-1010	
K-1225	
18-4208-0010	
18-4303-0000	
18-4315-0000	
18-4318-0000	
PC-1107	
K-3706	
OXYGEN	
20-4500-7000	
20-4502-6000	
20-4504-7000	
20-4505-7000	
20-4523-0000	
20-4525-0000	
PC-1006	
PC-1124	
AIR CONDITIONING - ATA 21	
15_7610-6000 (base model)	
K-1622 (R)	
15-7605-6010	
K-1622 (R)	
ELECTRICAL POWER - ATA 24	
11-2820-0000	
11-6610-6000	
112850	
112860	

Dassault/Falcon	
900, 900EX	
LIFTING & SHORING - ATA 7	ELECTRICAL POWER - ATA 24
02-1240C0111 Main (2)	11-2820-0000
02-1240C0111 Nose	11-6610-6000
02-7813C0100 Axle	112850
Dassault adapter (R)	112860
02-7947C0000	FUEL - ATA 28
03A5822C0000 Stabilizing Stand	07-3000-1921
03A5848C0000-A1 Stabilizing Stand	07-3006-6900
TOWING & TAXIING - ATA 9	H-2599 (R)
01-1201-0010	HYDRAULIC POWER - ATA 29
01-0612-0000 (R)	(base models)
01-1329-0000	5411-EB_C
01-0612-0000 (R)	54111EB_CEKQ4 50 hz countries
01-1215-0000	54111EB_CFKQ4 60 hz countries
01-0612-0000 (R)	KHC-1005
01-1211-0010	KHC-4020
01-1950-5000	06-5051-6500
01-1954-6000	K-2339 (R)
01-1954-6002	ICE & RAIN PROTECTION - ATA 30
eJP-10	09-6200-0010
K-5388 (R)	LANDING GEAR - ATA 32
eJP-12	14B6801-0120
K-5388 (R)	Z-1063-17 Main (R)
ETT-8X	Z-1064-10 Nose (R)
ETT-12X	14-6802-6000
TTR-6	14-6804-6000
TTR-8	14-6805-6010
TTR-12 - 900EX only	14-6806-6011
PARKING & MOORING - ATA 10	14-6807-6011
99-9028-6000	14-6808-6000
99-9045-9000	14-6883-0110
SERVICING - ATA 12	14-6892-6000
ENGINE OIL	FUSELAGE - ATA 53
06-5009C6800	04-6028C0121
06-5010-6800	K-3057 Crane Hook (R)
06-5022-6800	04-6030-5111
06-5042-0800	04-6031C0100
HYDRAULIC FLUID	04-6152-0120
06-4005-0511	K-2012 Gooseneck Boom Kit
06-4035-0500	K-2013 Pneumatic Pump Kit
06-5022-6500	K-2953 Hand Winch Kit
06-5042-0500	POWER PLANT - ATA 71
KHC-1339	08-0102-4010
LAVATORY	08-0102-4010
10-4036-0010	08-2001-0000
K-2410 (R)	K-2112 (R) TFE731-5BR
K-2412 (R)	08-2021C0000 - 900EX only
10-6408-0000	K-3861 (R) TFE731-60
K-2410 (R)	08-4049-0013
K-2412 (R)	
10-6408-0000	
K-2410 (R)	
K-2412 (R)	
10-6409-0000	
POTABLE WATER	
19-4305-0000	
19-4306-0000	
K-2411	
NITROGEN	
18-4201-1010	
K-1225	
18-4208-0010	
18-4303-0000	
18-4315-0000	
18-4318-0000	
PC-1107	
K-3706	
OXYGEN	
20-4500-7000	
20-4502-6000	
20-4504-7000	
20-4505-7000	
20-4523-0000	
20-4525-0000	
PC-1006	
PC-1124	
AIR CONDITIONING - ATA 21	
15_7603-1000 (base model)	
K-1622 (R)	

Dassault/Falcon	
2000, 2000EX	
LIFTING & SHORING - ATA 7	FUEL - ATA 28
02-1240C0111 Main (2) 02-1240C0111 Nose 02-7813C0100 Axle 02-7947C0000 03A5822C0000 Stabilizing Stand	07-3000-1921 07-3006-6900 H-2599 (R)
TOWING & TAXIING - ATA 9	HYDRAULIC POWER - ATA 29
01-1201-0010 01-0612-0000 (R) 01-1329-0000 01-0612-0000 (R) 01-1215-0000 01-0612-0000 (R) 01-1211-0010 01-1950-5000 01-1954-6000 01-1954-6002 eJP-10 K-5388 (R) eJP-12 K-5388 (R) ETT-8X ETT-12X TTR-6 TTR-8	(base models) 5J11-EB_C 5J1111EB_CEQK4 50 hz countries 541111EB_CFKQ4 50 hz countries KHC-1005 KHC-4020 06-5051-6500 K-2339 (R)
PARKING & MOORING - ATA 10	ICE & RAIN PROTECTION - ATA 30
99-9028-6000 99-9045-9000	09-6200-0010
SERVICING - ATA 12	LANDING GEAR - ATA 32
ENGINE OIL	14B6801-0120 Z-1063-17 Main (R) Z-1064-10 Nose (R) 14-6802-6000 14-6804-6000 14-6805-6010 14-6806-6011 14-6807-6011 14-6808-6000 14-6883-0110 14-6892-6000
06-5009C6800 06-5010-6800 06-5022-6800 06-5042-0800	FUSELAGE - ATA 53
HYDRAULIC FLUID	04-6028C0121 K-3057 Crane Hook (R) 04-6030-5111 04-6152-0120 K-2012 Gooseneck Boom Kit K-2013 Pneumatic Pump Kit K-2953 Hand Winch Kit
06-4005-0511 06-4035-0500 06-5022-6500 06-5042-0500 KHC-1339	POWER PLANT - ATA 71
LAVATORY	08-0144-4000 08-4049-0013
10-4036-0010 K-2410 (R) K-2412 (R) 10-6408-0000 K-2410 (R) K-2412 (R) 10-6409-0000	
POTABLE WATER	
19-4305-0000 19-4306-0000 K-2411	
NITROGEN	
18-4201-1010 K-1225 18-4208-0010 18-4303-0000 18-4315-0000 18-4318-0000 PC-1107 K-3706	
OXYGEN	
20-4500-7000 20-4502-6000 20-4504-7000 20-4505-7000 20-4523-0000 20-4525-0000 PC-1006 PC-1009 PC-1124	
AIR CONDITIONING - ATA 21	
15_7603-1000 (base model) K-1622 (R)	
ELECTRICAL POWER - ATA 24	
11-2820-0000 11-6610-6000 112850 112860	

Diamond Aircraft
DA20-A1, DA20-C1, DA40 Diamond Star
LIFTING & SHORING - ATA 7
02-0222C0111 Main (2) 02-7947C0000 03-4006-0000 Tailstand Adapter TBD (R)
TOWING & TAXIING - ATA 9
eJP-3 eJP-3L ETT-8X TTR-6 TTR-8
PARKING & MOORING - ATA 10
99-9010-6000
SERVICING - ATA 12
ENGINE OIL
06-5009C6800 06-5010-6800 06-5022-6800
HYDRAULIC FLUID
06-4005-0511 06-4035-0500 06-5022-6500 06-5042-0500
NITROGEN
18-4201-1010 K-1225 18-4208-0010 18-4303-0000 18-4315-0000 18-4318-0000 PC-1107 K-3706
OXYGEN
20-4500-7000 20-4502-6000 20-4504-7000 20-4505-7000 20-4523-0000 20-4525-0000 PC-1006 PC-1124
AIR CONDITIONING - ATA 21
15_7610-6000 (base model) K-1622 (R) 15-7605-6010 K-1622 (R)
ELECTRICAL POWER - ATA 24
11-6602-1000 11-6610-6000 11-2820-0000 - DA40 Diamond Star only 92-0552-9000 92-0552-9001
FUEL - ATA 28
07-3000-1921 07-3006-6900
LANDING GEAR - ATA 32
14B6801-0120 Z-1063-07 Main (R) Z-1063-06 Nose (R) 14-6802-6000 14-6804-6000 14-6805-6010 14-6806-6011 14-6807-6011 14-6808-6000 14-6892-6000
FUSELAGE - ATA 53
04-6028C0121 K-3057 Crane Hook (R) 04-6152-0120 K-2012 Gooseneck Boom Kit K-2013 Pneumatic Pump Kit K-2953 Hand Winch Kit

Eclipse
500
LIFTING & SHORING - ATA 7
02-0517C0140 Main (2) 02-0522C0141 Tail 02-7947C0000
TOWING & TAXIING - ATA 9
01-1202-0000 01-0598-0000 (R) 01-1298-0000 01-2001-0000 01-1950-5000 01-1954-6000 01-1954-6200 eJP-3 eJP-3L ETT-8X TTR-6 TTR-8
PARKING & MOORING - ATA 10
99-9008-6000 99-9028-0000
SERVICING - ATA 12
ENGINE OIL
06-5009C6500 06-5010-6500 06-5022-6500 06-5042-0500
HYDRAULIC FLUID
06-4005-0511 06-4035-0500 06-5022-6500 06-5042-0500
NITROGEN
18-4201-1010 K-1225 18-4208-0010 18-4303-0000 18-4315-0000 18-4318-0000 PC-1107 K-3706
OXYGEN
20-4500-7000 20-4502-6000 20-4504-7000 20-4505-7000 20-4523-0000 20-4525-0000 PC-1006 PC-1124 K-3337
AIR CONDITIONING - ATA 21
15_7603-6000 (base model)
ELECTRICAL POWER - ATA 24
11-2820-0000 11-6610-6000 112850 112860
FUEL - ATA 28
07-3000-1921
LANDING GEAR - ATA 32
14-6802-6000 14-6804-6000 14-6805-6010 14-6806-6011 14-6807-6011 14-6808-6000 14-6877-6012
FUSELAGE - ATA 53
04-6152-0120 K-2012 Gooseneck Boom Kit K-2013 Pneumatic Pump Kit K-2953 Hand Winch Kit
POWER PLANT - ATA 71
08-4060-6700 08-4048-0013

For detailed model information reference the items page(s) • Bracketed # = quantity • R = required

Embraer		Embraer	
E170 (ERJ-170), E175 (ERJ-175), E175-E2		E190 (ERJ-190), E190-E2, E195 (ERJ-195), E195-E2	
LIFTING & SHORING - ATA 7	LANDING GEAR - ATA 32	LIFTING & SHORING - ATA 7	LANDING GEAR - ATA 32
02A7868C0100 Main (2) 02A7869C0100 Tail 02-7861C0100 Axle Nose 02A7867C0100 Axle Main Axle Main & Nose Alternative: 02-7854C0110	14-6801-0120 Z-3072-21 Main (R) Z-1063-13 Nose (R) 14-6802-6000 14-6804-6000 14-6805-6010 14-6806-6011 14-6807-6011 14-6808-6000 14-6892-6000 17500M	02A7868C0100 Main (2) 02A7869C0100 Tail 02-7861C0100 Axle Nose 02A7867C0100 Axle Main	14-6802-6000 14-6804-6000 14-6805-6010 14-6806-6011 14-6807-6011 14-6808-6000 14-6892-6000 17500M
TOWING & TAXIING - ATA 9	FUSELAGE - ATA 53	TOWING & TAXIING - ATA 9	FUSELAGE - ATA 53
eJP-10 eJP-12	04-6052-0000 04-6028C0121 K-3057 Crane Hook (R) 04-6029-5111 04-6029-5111-A5 04-6152-0120 K-2012 Gooseneck Boom Kit K-2013 Pneumatic Pump Kit K-2953 Hand Winch Kit	E190 (ERJ-190), E195 (ERJ-195): 01A1297-0100 01B1297-0100 01A1302-0000 01B1302-0000	04-6028C0121 K-3057 Crane Hook (R) 04-6029-5111 04-6029-5111-A5 04-6152-0120 K-2012 Gooseneck Boom Kit K-2013 Pneumatic Pump Kit K-2953 Hand Winch Kit
E170 (ERJ-170), E175 (ERJ-175) only: 01A1297-0100 01B1297-0100 01A1302-0000 01B1302-0000		01B1399-0100 - E190-E2, E195-E2 only	
PARKING & MOORING - ATA 10		PARKING & MOORING - ATA 10	
99-9028-6000		99-9028-6000	
SERVICING - ATA 12		PARKING & MOORING - ATA 10	
ENGINE OIL		ENGINE OIL	
06-5010-6800 06-5022-6800 06-5042-0800 06-5073-0800 KHC-2173 (R)		06-5010-6800 06-5022-6800 06-5042-0800 06-5073-0800 KHC-2173 (R)	
HYDRAULIC FLUID		HYDRAULIC FLUID	
06-4005-3611 06-4035-3600 06-5004C3600 06-5022-6600 06-5042-3600 KHC-3558 KHC-3560		06-4005-3611 06-4035-3600 06-5004C3600 06-5022-6600 06-5042-3600 KHC-3558 KHC-3560	
LAVATORY		LAVATORY	
10-6402-0010 K-2410 (R) K-2922 (R) 10-6403-6000 10-6412-0000 K-2410 (R) K-2922 (R)		10-6402-0010 K-2410 (R) K-2922 (R) 10-6403-6000 10-6412-0000 K-2410 (R) K-2922 (R)	
POTABLE WATER		POTABLE WATER	
19-4305-0000 K-2411 (R) 19-4306-0000 K-2411 (R)		19-4305-0000 K-2411 (R) 19-4306-0000 K-2411 (R)	
NITROGEN		NITROGEN	
18-4201-1010 K-1225 18-4208-0010 18-4303-0000 18-4315-0000 18-4318-0000 PC-1107 K-3706		18-4201-1010 K-1225 18-4208-0010 18-4303-0000 18-4315-0000 18-4318-0000 PC-1107 K-3706	
OXYGEN		OXYGEN	
20-4500-7000 20-4502-6000 20-4504-7000 20-4505-7000 20-4523-0000 20-4525-0000 PC-1006 PC-1124		20-4500-7000 20-4502-6000 20-4504-7000 20-4505-7000 20-4523-0000 20-4525-0000 PC-1006 PC-1124	
ELECTRICAL POWER - ATA 24		ELECTRICAL POWER - ATA 24	
11-4090-0000 11-4290-0000 11-6610-6000		11-4090-0000 11-4290-0000 11-6610-6000	
FUEL - ATA 28		FUEL - ATA 28	
07-3000-1921 07-3020-6900		07-3000-1921 07-3020-6900	
HYDRAULIC POWER - ATA 29		HYDRAULIC POWER - ATA 29	
5731-GM_C (base model) KHC-3559 KHC-3561 KHC-4030 673A AGE13604A 13-6605-6000		5731-GM_C (base model) KHC-3559 KHC-3561 KHC-4030 673A AGE13604A 13-6605-6000	
ICE & RAIN PROTECTION - ATA 30		ICE & RAIN PROTECTION - ATA 30	
09-6200-0010		09-6200-0010	

Embraer	
EMB-110	
LIFTING & SHORING - ATA 7	LANDING GEAR - ATA 32
02-7856C0100 Main (2) 02-7856C0100 Nose 02-7947C0000 03A5802C0000 Tailstand	14-6801-0120 Z-1063-15 Main (R) Z-1063-11 Nose (R)
TOWING & TAXIING - ATA 9	14-6802-6000 14-6804-6000 14-6805-6010 14-6806-6011 14-6807-6011 14-6808-6000 14-6883-0110 14-6892-6000
01-1201-0010 01-0554-0000 (R) 01-1215-0000 01-0554-0000 (R) 01-1950-5000 01-1954-6000 01-1954-6002 eJP-3 eJP-3L	FUSELAGE - ATA 53
PARKING & MOORING - ATA 10	04-6028C0121 Z-4082 Lift Tray (R)
99-9008-6000	04-6029-5111 04-6029-5111-A5 04-6150-0120 K-2012 Gooseneck Boom Kit K-2013 Pneumatic Pump Kit K-2953 Hand Winch Kit
SERVICING - ATA 12	POWER PLANT - ATA 71
ENGINE OIL	08-0100-4000 08-2001-0000 K-2115 (R) 08T4049-0013 K-1152 (R)
06-5009C6800 06-5010-6800 06-5022-6800	
HYDRAULIC FLUID	
06-4005-0511 06-4035-0500 06-5022-6500 06-5042-0500	
LAVATORY	
10-4036-0010 K-2029 (R) K-2410 (R) 10-6403-6000 10-6408-0000 K-2029 (R) K-2410 (R) 10-6409-0000	
POTABLE WATER	
19-4305-0000 19-4306-0000 K-2411	
NITROGEN	
18-4200-1100 K-1225 18-4208-0010 18-4303-0000 18-4315-0000 18-4318-0000 PC-1107 K-3706	
OXYGEN	
20-4500-7000 20-4502-6000 20-4504-7000 20-4505-7000 20-4523-0000 20-4525-0000 PC-1006 PC-1009 PC-1124	
AIR CONDITIONING - ATA 21	
15_7603-1000 (base model)	
ELECTRICAL POWER - ATA 24	
11-2820-0000 112850 112860	
FUEL - ATA 28	
07-3000-1921 07-3006-6900	
HYDRAULIC POWER - ATA 29	
5110-AN (base model) KHC-1015	
ICE & RAIN PROTECTION - ATA 30	
09-6200-0010	

Embraer	
EMB-120	
LIFTING & SHORING - ATA 7	LANDING GEAR - ATA 32
02-1032C0111 Main (2) R-1276 (1) 02-1032C0111 Nose 02-7947C0000	14-6801-0120 Z-1063-14 Main (R) Z-1063-11 Nose (R)
TOWING & TAXIING - ATA 9	14-6802-6000 14-6804-6000 14-6805-6010 14-6806-6011 14-6807-6011 14-6808-6000 14-6883-0110 14-6892-6000
01-1201-0010 01-0540-0010 (R) 01-1215-0000 01-0540-0010 (R) 01-1290-0100 01-0540-0010 (R) 01-1950-5000 01-1954-6000 01-1954-6002 eJP-3 eJP-3L	FUSELAGE - ATA 53
PARKING & MOORING - ATA 10	04-6028C0121 Z-4082 Lift Tray (R)
99-9008-6000	04-6029-5111 04-6029-5111-A5 04-6150-0120 K-2012 Gooseneck Boom Kit K-2013 Pneumatic Pump Kit K-2953 Hand Winch Kit
SERVICING - ATA 12	POWER PLANT - ATA 71
ENGINE OIL	08-0112-4000 08-2014-0000 08-4049-0013
06-5009C6800 06-5010-6800 06-5022-6800 06-5042-0800	
HYDRAULIC FLUID	
06-4005-0511 06-4035-0500 06-5022-6500 06-5042-0500 06-5043-1500	
LAVATORY	
10-4036-0010 K-2029 (R) K-2410 (R) 10-6403-6000 10-6408-0000 K-2029 (R) K-2410 (R) 10-6409-0000	
POTABLE WATER	
19-4305-0000 19-4306-0000 K-2411	
NITROGEN	
18-4200-1100 K-1225 18-4208-0010 18-4303-0000 18-4315-0000 18-4318-0000 PC-1107 K-3706	
OXYGEN	
20-4500-7000 20-4502-6000 20-4504-7000 20-4505-7000 20-4523-0000 20-4525-0000 PC-1006 PC-1009 PC-1124	
AIR CONDITIONING - ATA 21	
15_7603-1000 (base model) K-1360 (R)	
ELECTRICAL POWER - ATA 24	
11-2820-0000 112850 112860	
FUEL - ATA 28	
07-3000-1921 07-3006-6900	
HYDRAULIC POWER - ATA 29	
5110-AN (base model) KHC-1015	

For detailed model information reference the items page(s) • Bracketed # = quantity • R = required

Embraer	
ERJ-135/140/145, Legacy 600/650	
LIFTING & SHORING - ATA 7	LANDING GEAR - ATA 32
02A1248C0112 Main (2)	14-6801-0120
02-7837C0110 Nose	Z-1063-17 Main (R)
02-7813C0100 Axle	Z-1064-10 Nose (R)
02-7947C0000	14-6802-6000
TOWING & TAXIING - ATA 9	14-6804-6000
01-1201-0010	14-6805-6010
01-0582-0011 (R)	14-6806-6011
01-1215-0000	14-6807-6011
01-0582-0011 (R)	14-6808-6000
01-1290-0100	14-6883-0110
01-0582-0011 (R)	14-6892-6000
01-1950-5000	FUSELAGE - ATA 53
01-1954-6000	04-6029-5111
01-1954-6002	04-6029-5111-A5
PARKING & MOORING - ATA 10	04-6028C0121
99-9029-6000	K-3057 Crane Hook (R)
SERVICING - ATA 12	04-6032-0100
ENGINE OIL	K-3712 (R) - ERJ-140/145 only
06-5009C6800	04-6152-0120
06-5010-6800	K-2012 Gooseneck Boom Kit
06-5022-6800	K-2013 Pneumatic Pump Kit
HYDRAULIC FLUID	K-2953 Hand Winch Kit
06-4005-3611	POWER PLANT - ATA 71
06-4035-3600	08-0129-4000
06-5022-6600	08-2029-0000
06-5042-3600	08-4049-0013
KHC-3651	
LAVATORY	
10-4036-0010	
K-2029 (R)	
K-2410 (R)	
10-6403-6000	
10-6408-0000	
K-2029 (R)	
K-2410 (R)	
10-6409-0000	
POTABLE WATER	
19-4305-0000	
19-4306-0000	
K-2411	
NITROGEN	
18-4200-1100	
K-1225	
18-4208-0010	
18-4303-0000	
18-4315-0000	
18-4318-0000	
PC-1107	
K-3706	
OXYGEN	
20-4500-7000	
20-4502-6000	
20-4504-7000	
20-4505-7000	
20-4523-0000	
20-4525-0000	
PC-1006	
PC-1124	
AIR CONDITIONING - ATA 21	
ERJ-135/140/145 only :	
15_7603-1000 (base model)	
Legacy 600/650 only:	
15_7606-1000 (base model)	
ELECTRICAL POWER - ATA 24	
11-2820-0000	
11-6610-6000 - ERJ-140 only	
112850	
112860	
FUEL - ATA 28	
07-3000-1921	
07-3007-6900 - ERJ-135/140/145 only	
07-3020-3900 - Legacy 600/650 only	
HYDRAULIC POWER - ATA 29	
5231-BY (base model)	
KHC-2628	
ICE & RAIN PROTECTION - ATA 30	
09-6200-0010	

KC-390
SERVICING - ATA 12
ENGINE OIL
06-5021-1800
06-5022-6800
06-5042-0800
HYDRAULIC FLUID
06-5040-3600
06-5042-3600
06-5074-0600
LAVATORY
10-4036-0010
K-2410 (R)
K-2412 (R)
POTABLE WATER
19-4305-0000
OXYGEN
20-4506-6000
FUEL - ATA 28
07-3006-6900
HYDRAULIC POWER - ATA 29
5933XEE2CHLMN4
KHC-1008
LANDING GEAR - ATA 32
14-6802-6000
14-6804-6000
14-6808-6000
14-6892-6000
FUSELAGE - ATA 53
04-6028C0121

Embraer	
Legacy 450/500, Praetor	
LIFTING & SHORING - ATA 7	HYDRAULIC POWER - ATA 29
02A7845C0120 Main (3)	5631-KX (base model)
2 - main, 1 - nose	5J31-KX (base model)
02-7863C0100 Axle	56311KX_FCLMRY4 (50 hz countries)
02-7947C0000	5J311KX_FCLMRY4 (50 hz countries)
03A5845C0000 Stabilizing Stand	KHC-1008
TOWING & TAXIING - ATA 9	KHC-2628
01-1202-0020	AGE17074A
01-0622-0000 (R)	ICE & RAIN PROTECTION - ATA 30
01-1215-0000	09-6200-0010
01-0622-0000 (R)	LANDING GEAR - ATA 32
01-1950-5000	14-6801-0120
01-1290-0100	Z-1063-17 Main (R)
01-0622-0000 (R)	Z-1063-11 Nose (R)
01-1954-6000	14-6802-6000
01-1954-6002	14-6804-6000
eJP-10 - Praetor only	14-6805-6010
PARKING & MOORING - ATA 10	14-6806-6011
99-9028-6024	14-6807-6011
99-9029-6000	14-6808-6000
SERVICING - ATA 12	14-6883-0110
ENGINE OIL	14-6892-6000
06-5009C6800	14-6923-0110
06-5010-6800	FUSELAGE - ATA 53
06-5022-6800	04-6029-5111
Praetor only:	04-6029-5111-A5
06-5041-0800 Landing Gear Shock	04-6028C0121
HYDRAULIC FLUID	K-3057 Crane Hook (R)
06-4005-3611	K-3712 (R)
06-4035-3600	04-6032-0100
06-5022-6600	04-6152-0120
KHC-3651	K-2012 Gooseneck Boom Kit
LAVATORY	K-2013 Pneumatic Pump Kit
10-4036-0010	K-2953 Hand Winch Kit
K-2029 (R)	POWER PLANT - ATA 71
K-2410 (R)	08-4048-0013 - Legacy 500, Praetor only
10-6403-6000	08-4049-0013 - Legacy 450 only
10-6408-0000	
K-2029 (R)	
K-2410 (R)	
10-6409-0000	
POTABLE WATER	
19-4305-0000	
19-4306-0000	
K-2411	
NITROGEN	
18-4200-1100	
18-4208-0010	
18-4303-0000	
18-4315-0000	
18-4318-0000	
PC-1107	
K-3706	
OXYGEN	
20-4500-7000	
20-4502-6000	
20-4504-7000	
20-4505-7000	
20-4523-0000	
20-4525-0000	
PC-1006	
PC-1124	
AIR CONDITIONING - ATA 21	
15_7603-1000 (base model)	
Legacy 600/650 only:	
15_7606-1000 (base model)	
ELECTRICAL POWER - ATA 24	
11-2820-0000	
11-6610-6000 - ERJ-140 only	
112850	
112860	
FUEL - ATA 28	
07-3000-1921	
07-3007-6900 - ERJ-135/140/145 only	
07-3020-3900 - Legacy 600/650 only	
HYDRAULIC POWER - ATA 29	
5231-BY (base model)	
KHC-2628	
ICE & RAIN PROTECTION - ATA 30	
09-6200-0010	

Embraer	
Lineage 1000	
LIFTING & SHORING - ATA 7	LANDING GEAR - ATA 32
02A7868C0100 Main (2) 02A7869C0100 Tail 02-7861C0100 Axle Nose 02A7867C0100 Axle Main Axle Main & Nose Alternative: 02-7854C0110	14-6801-0120 Z-3072-21 Main (R) Z-1063-13 Nose (R) 14-6802-6000 14-6804-6000 14-6805-6010 14-6806-6011 14-6807-6011 14-6808-6000 14-6892-6000
TOWING & TAXIING - ATA 9	FUSELAGE - ATA 53
01A1332-0000 01A1336-0100 eJP-12	04-6028C0121 K-3057 Crane Hook (R) 04-6029-5111 04-6029-5111-A5 04-6152-0120 K-2012 Gooseneck Boom Kit K-2013 Pneumatic Pump Kit K-2953 Hand Winch Kit
PARKING & MOORING - ATA 10	
99-7136-6000 99-9028-6000	
SERVICING - ATA 12	
ENGINE OIL	
06-5010-6800 06-5022-6800 06-5042-0800 06-5073-0800 KHC-2173 (R)	
HYDRAULIC FLUID	
06-4005-3611 06-4035-3600 06-5004C3600 06-5022-6600 06-5042-3600 KHC-3558 KHC-3560	
LAVATORY	
10-4036-0010 K-2029 (R) K-2410 (R) 10-6403-6000 10-6408-0000 K-2029 (R) K-2410 (R)	
POTABLE WATER	
19-4305-0000 19-4306-0000 K-2411	
NITROGEN	
18-4201-1010 K-1225 18-4208-0010 18-4303-0000 18-4315-0000 18-4318-0000 PC-1107 K-3706	
OXYGEN	
20-4500-7000 20-4502-6000 20-4504-7000 20-4505-7000 20-4523-0000 20-4525-0000 PC-1006 PC-1124	
ELECTRICAL POWER - ATA 24	
11-6610-6000	
FUEL - ATA 28	
07-3000-1921 07-3020-6900	
HYDRAULIC POWER - ATA 29	
5731-GM_C (base model) KHC-3559 KHC-3561 KHC-4030 673A AGE 13604A 13-6605-6000	
ICE & RAIN PROTECTION - ATA 30	
09-6200-0010	

Embraer
Tucano
SERVICING - ATA 12
HYDRAULIC FLUID
06-5052-3600
HYDRAULIC POWER - ATA 29
5211-EN_C (base model) KHC-1015
LANDING GEAR - ATA 32
14-6802-6000 14-6804-6000 14-6806-6011 14-6807-6011 14-6808-6000
FUSELAGE - ATA 53
04-6152-0120

Embraer
Phenom 100
LIFTING & SHORING - ATA 7
02-0522C0141 Main (2) 02-0522C0141 Tail 02-7947C0000
TOWING & TAXIING - ATA 9
01-1202-0000 01-0624-0000 (R) 01-1324-0000 01-2002-0000 01-1950-5000 eJP-3 eJP-3L
PARKING & MOORING - ATA 10
99-9008-6000 99-9028-0000
SERVICING - ATA 12
ENGINE OIL
06-5009C6800 06-5010-6800 06-5022-6800 06-5042-0800
HYDRAULIC FLUID
06-4005-0800 06-4035-0800 06-5009C6800 06-5010-6800 06-5022-6800 06-5042-0800 KHC-4014
NITROGEN
12-3104-0000 18-4200-1100 K-1225 18-4208-0010 18-4303-0000 18-4315-0000 18-4318-0000 PC-1107 K-3706
OXYGEN
12-3104-0000 20-4500-7000 20-4502-6000 20-4505-7000 20-4523-0000 PC-1006 K-3337
AIR CONDITIONING - ATA 21
15_7603-1000 (base model)
ELECTRICAL POWER - ATA 24
11-2820-0000 11-6644C1010 112850 112860
FUEL - ATA 28
07-3000-1921
HYDRAULIC POWER - ATA 29
5241-CN (base model) KHC-2738
LANDING GEAR - ATA 32
14-6801-0120 Z-1064-09 Main (R) w/out chine Z-1064-13 Main (R) with chine Z-1063-09 Nose (R) w/out chine Z-1063-13 Nose (R) with chine 14-6802-6000 14-6804-6000 14-6805-6010 14-6806-6011 14-6807-6011 14-6808-6000 14-6892-6000
FUSELAGE - ATA 53
04-6152-0120 K-2013 Pneumatic Pump Kit K-2953 Hand Winch Kit
POWER PLANT - ATA 71
08-4060-6700 08-4048-0013

Embraer
Phenom 300
LIFTING & SHORING - ATA 7
02-8130C0100 Main (2) 02-8130C0100 Fuselage 02-7947C0000 03A5845C0000
TOWING & TAXIING - ATA 9
01-1202-0000 01-0606-0000 (R) 01-2007-0000 eJP-3 eJP-3L
PARKING & MOORING - ATA 10
99-9008-6000 99-9028-0000
SERVICING - ATA 12
ENGINE OIL
06-5009C6800 06-5010-6800 06-5022-6800 06-5042-0800
HYDRAULIC FLUID
06-4005-0800 06-4035-0800 06-5009C6800 06-5010-6800 06-5022-6800 06-5042-0800 KHC-4014
LAVATORY
10-4036-0010 K-2029 (R) K-2410 (R) 10-6409-0000
NITROGEN
12-3104-0000 18-4200-1100 K-1225 18-4208-0010 18-4303-0000 18-4315-0000 18-4318-0000 PC-1107 K-3706
OXYGEN
12-3104-0000 20-4500-7000 20-4502-6000 20-4505-7000 20-4523-0000 PC-1006 PC-1124 K-3337
AIR CONDITIONING - ATA 21
15_7603-1000 (base model)
ELECTRICAL POWER - ATA 24
11-2820-0000 112850 112860
FUEL - ATA 28
07-3000-1921
HYDRAULIC POWER - ATA 29
5241-CN (base model) KHC-2738
ICE & RAIN PROTECTION - ATA 30
09-6200-0010
LANDING GEAR - ATA 32
14-6801-0120 Z-1063-15 Main (R) w/out chine Z-1064-15 Main (R) with chine Z-1063-09 Nose (R) w/out chine Z-1064-09 Nose (R) with chine 14-6802-6000 14-6804-6000 14-6805-6010 14-6806-6011 14-6807-6011 14-6808-6000 14-6892-6000
FUSELAGE - ATA 53
04-6152-0120 K-2013 Pneumatic Pump Kit K-2953 Hand Winch Kit
POWER PLANT - ATA 71
08-4048-0013

For detailed model information reference the items page(s) • Bracketed # = quantity • R = required

Fairchild-Dornier	
Dornier 228-100/200	
LIFTING & SHORING - ATA 7	
02-0522C0141 Main (2) TR-1310 (2) (R) 02-0234-0111 Nose 02-0544C0110 Aft 02-7853C0100 Axle 02-7933C0100 Axle Alternative 02-7947C0000	
TOWING & TAXIING - ATA 9	
01-1201-0010 01-0534-0000 (R) 01-1155-0000 01-1954-6000 01-1954-6002 ETT-8X TTR-6 TTR-8	
ELECTRICAL POWER - ATA 24	
11-2820-0000	

Fairchild-Dornier	
Dornier 328/328 Jet	
LIFTING & SHORING - ATA 7	HYDRAULIC POWER - ATA 29
02-1256C0111 Main (2) 02-7828C0110 Nose 02-7813C0100 Axle 02-7947C0000 03-5814-0000 Wing Stabilizing Stand (2)	5110-CN (base model) KHC-2738 ICE & RAIN PROTECTION - ATA 30 09-6200-0010
TOWING & TAXIING - ATA 9	LANDING GEAR - ATA 32
01-1201-0010 01-0576-0000 (R) 01-1215-0000 01-0576-0000 (R) 01-1290-0100 01-0576-0000 (R) 01-1950-5000 01-1954-6000 01-1954-6002 ETT-8X TTR-6 TTR-8	14-6801-0120 Z-1063-10 Main (R) - 328 only Z-1063-17 Main (R) - 328 Jet only Z-1064-08 Nose (R) - 328 only Z-1064-10 Nose (R) - 328 Jet only 14-6802-6000 14-6804-6000 14-6805-6010 14-6806-6011 14-6807-6011 14-6808-6000 14-6883-0110 14-6892-6000
PARKING & MOORING - ATA 10	FUSELAGE - ATA 53
99-9028-6000	04-6001-1100 04-6028C0121 K-3057 Crane Hook (R) Z-4082 Lift Tray (R) 04-6029-5111 04-6029-5111-A5 04-6152-0120 K-2012 Gooseneck Boom Kit K-2013 Pneumatic Pump Kit K-2953 Hand Winch Kit
SERVICING - ATA 12	PROPELLER - ATA 61
ENGINE OIL	08-0503-4000 08-2028-0000
06-5009C6800 06-5010-6800 06-5022-6800 06-5042-0800	POWER PLANT - ATA 71
HYDRAULIC FLUID	08-0139-4000 08-4049-0013
06-4005-0511 06-4035-0500 06-5022-6500 06-5042-0500 06-5043-1500	328 only: 08-0113-4000 08-0126-4000 08-2014-0000
LAVATORY	
10-4036-0010 K-2029 (R) K-2410 (R) 10-6403-6000 10-6408-0000 K-2029 (R) K-2410 (R) 10-6409-0000	
POTABLE WATER	
19-4305-0000 19-4306-0000 K-2411	
NITROGEN	
18-4201-1010 K-1225 18-4208-0010 18-4303-0000 18-4315-0000 18-4318-0000 PC-1107 K-3706	
OXYGEN	
20-4500-7000 20-4502-6000 20-4504-7000 20-4505-7000 20-4523-0000 20-4525-0000 PC-1006 PC-1124	
AIR CONDITIONING - ATA 21	
15_7603-1000 (base model)	
ELECTRICAL POWER - ATA 24	
11-2820-0000 11-4090-0000 11-4290-0000 11-6610-6000	
FUEL - ATA 28	
07-3000-1921 07-3004-6900 07-3006-6900	

Fairchild-Dornier	
Envoy-3	
LIFTING & SHORING - ATA 7	
02-1256C0111 Main (2) 02-7828C0110 Nose 02-7813C0100 Axle 02-7947C0000 03-5714-0000 Wing Stabilizing Stand (2)	
TOWING & TAXIING - ATA 9	
01-1201-0010 01-0576-0000 (R) 01-1954-6000 01-1954-6002 eJP-3 eJP-3L ETT-8X TTR-6 TTR-8	
ELECTRICAL POWER - ATA 24	
11-2820-0000	
HYDRAULIC POWER - ATA 29	
5110-CN (base model) KHC-2738	

Merlin II	
LIFTING & SHORING - ATA 7	
02-0536-0110 Main (2) 02-0536-0110 Nose 02-7947C0000	
TOWING & TAXIING - ATA 9	
eJP-3 eJP-3L ETT-8X TTR-6 TTR-8	
ELECTRICAL POWER - ATA 24	
11-2820-0000	

Fairchild-Dornier	
Merlin III/IV	
LIFTING & SHORING - ATA 7	FUSELAGE - ATA 53
02-0544C0110 Main (2) 02-0544C0110 Nose 02-7947C0000	04-6028C0121 K-3057 Crane Hook (R) Z-4082 Lift Tray (R)
TOWING & TAXIING - ATA 9	04-6029-5111 04-6029-5111-A5 04-6150-0120 K-2012 Gooseneck Boom Kit K-2013 Pneumatic Pump Kit K-2953 Hand Winch Kit
01-1202-0000 01-0507-0000 (R) 01-1142-0000 01-1263-0000 01-1950-5000 01-1954-6000 01-1954-6002 eJP-3 eJP-3L ETT-8X TTR-6 - Merlin III only TTR-8 - Merlin III only	POWER PLANT - ATA 71
PARKING & MOORING - ATA 10	08-0100-4000 08-0103-4000 08-2001-0000 K-2115 (R) 08-2023-0010 K-2110 (R) 08-4048-0013 K-1057 (R) K-1152 (R)
99-9028-6000	
SERVICING - ATA 12	
ENGINE OIL	
06-5009C6800 06-5010-6800 06-5022-6800 06-5042-0800	
HYDRAULIC FLUID	
06-4005-0511 06-4035-0500 06-5022-6500 06-5042-0500	
NITROGEN	
18-4200-1100 K-1225 18-4208-0010 18-4303-0000 18-4315-0000 18-4318-0000 PC-1107 K-3706	
OXYGEN	
20-4500-7000 20-4502-6000 20-4504-7000 20-4505-7000 20-4523-0000 20-4525-0000 PC-1006 PC-1124	
AIR CONDITIONING - ATA 21	
15_7603-1000 (base model)	
ELECTRICAL POWER - ATA 24	
11-2820-0000 112850 112860	
FUEL - ATA 28	
07-3000-1921 07-3006-6900	
HYDRAULIC POWER - ATA 29	
5120-AC (base model) KHC-1006	
ICE & RAIN PROTECTION - ATA 30	
09-6200-0010	
LANDING GEAR - ATA 32	
14-6801-0120 Z-1063-11 Main (R) Z-1064-13 Nose (R) 14-6802-6000 14-6804-6000 14-6805-6010 14-6806-6011 14-6807-6011 14-6808-6000 14-6883-0110 14-6892-6000	

For detailed model information reference the items page(s) • Bracketed # = quantity • R = required

Fokker	
27	
LIFTING & SHORING - ATA 7	
02-7802C0111 Main (2) 02-7830C0110 Axle 02-7947C0000	
TOWING & TAXIING - ATA 9	
01-1201-0010 01-0514-0000 (R) 01-1954-6000 01-1954-6002 ETT-8X TTR-6 TTR-8	
ELECTRICAL POWER - ATA 24	
11-2820-0000	

Fokker	
28	
LIFTING & SHORING - ATA 7	
02-2560C0110 Main (2) 02-1248C0112 Tail 02-7830C0110 Axle 02-7947C0000	
TOWING & TAXIING - ATA 9	
01-1176-0010 ETT-8X ETT-12X TTR-6 TTR-8	
ELECTRICAL POWER - ATA 24	
11-2820-0000 11-4090-0000 11-4290-0000	
HYDRAULIC POWER - ATA 29	
5631 (base model) KHC-1008 KHC-4025	

Fokker	
70	
LIFTING & SHORING - ATA 7	
02-2560C0110 Main (2) 02-7810C0111 Nose 02-7813C0100 Axle Nose 02-7830C0110 Axle 02-7947C0000	
TOWING & TAXIING - ATA 9	
01-1236-0000 eJP-10 eJP-12 ETT-8X ETT-12X TTR-6 TTR-8	
ELECTRICAL POWER - ATA 24	
11-2820-0000	
HYDRAULIC POWER - ATA 29	
5631-FC (base model) KHC-1160 KHC-4029	
LANDING GEAR - ATA 32	
17500M BC300P (R) 17500S-2 BC300P (R)	

Fokker	
50	
LIFTING & SHORING - ATA 7	LANDING GEAR - ATA 32
02-7802C0111 Main (2) 02-0517C0140 Nose 02-7830C0110 Axle 02-7947C0000	14-6801-0120 Z-1063-10 Main (R) Z-1063-17 Main (R) 14-6802-6000 14-6804-6000 14-6805-6010 14-6806-6011 14-6807-6011 14-6808-6000 14-6830-6012 14-6883-0110 14-6892-6000
TOWING & TAXIING - ATA 9	FUSELAGE - ATA 53
01-1201-0010 01-0569-0000 (R) 01-1290-0100 01-0569-0000 (R) 01-1217-0000 01-1950-5000 01-1954-6000 01-1954-6002 ETT-8X TTR-6 TTR-8	04-6001-1100 04-6028C0121 K-3057 Crane Hook (R) Z-4082 Lift Tray (R) 04-6029-5111 04-6029-5111-A5 04-6150-0120 K-2012 Gooseneck Boom Kit K-2013 Pneumatic Pump Kit K-2953 Hand Winch Kit
PARKING & MOORING - ATA 10	
99-9028-6000	
SERVICING - ATA 12	
ENGINE OIL	
06-5009C6800 06-5010-6800 06-5022-6800	
HYDRAULIC FLUID	
06-4005-0511 06-4035-0500 06-5022-6500 06-5042-0500 06-5043-1500	
LAVATORY	
10-6402-0010 K-2029 (R) K-2410 (R) 10-6403-6000 10-6412-0000 K-2029 (R) K-2410 (R)	
POTABLE WATER	
19-4305-0000 19-4306-0000 K-2411	
NITROGEN	
18-4201-1010 K-1225 18-4208-0010 18-4303-0000 18-4315-0000 18-4318-0000 PC-1107 K-3706	
OXYGEN	
20-4500-7000 20-4502-6000 20-4504-7000 20-4505-7000 20-4523-0000 PC-1006 PC-1009 PC-1124	
AIR CONDITIONING - ATA 21	
15_7603-1000 (base model)	
ELECTRICAL POWER - ATA 24	
11-2820-0000 11-4090-0000 11-4290-0000 11-6610-6000	
FUEL - ATA 28	
07-3000-1921 07-3006-6900	
HYDRAULIC POWER - ATA 29	
5611-BK (base model) KHC-1678	
ICE & RAIN PROTECTION - ATA 30	
09-6200-0010	

Fokker	
100	
LIFTING & SHORING - ATA 7	
02-7813C0100 Axle	
TOWING & TAXIING - ATA 9	
01-1326-0000 01-1950-5000 eJP-10 eJP-12 ETT-8X ETT-12X TTR-8 TTR-12	
PARKING & MOORING - ATA 10	
99-9028-6000	
SERVICING - ATA 12	
ENGINE OIL	
06-5009C6800 06-5010-6800 06-5022-6800 06-5042-0800	
HYDRAULIC FLUID	
06-4005-3611 06-4035-3600 06-5022-6600 06-5042-3600 06-5043-3600 KHC-1081	
LAVATORY	
10-6412-0000 K-2029 (R) K-2410 (R) 10-6403-6000	
POTABLE WATER	
19-4305-0000 19-4306-0000 K-2411	
NITROGEN	
18-4201-1010 K-1225 18-4208-0010 18-4303-0000 18-4315-0000 18-4318-0000 PC-1107 K-3706	
OXYGEN	
20-4500-7000 20-4502-6000 20-4504-7000 20-4505-7000 20-4523-0000 20-4525-0000 PC-1006 PC-1009 PC-1124	
ELECTRICAL POWER - ATA 24	
11-4090-0000 11-4290-0000 11-6610-6000	
FUEL - ATA 28	
07-3000-1921 07-3006-6900	
HYDRAULIC POWER - ATA 29	
5431-FC (base model) KHC-1160 KHC-4029	
LANDING GEAR - ATA 32	
14-6801-0120 Z-1063-10 Main (R) Z-1063-17 Main (R) 14-6802-6000 14-6804-6000 14-6805-6010 14-6806-6011 14-6807-6011 14-6808-6000 14-6830-6012 14-6878-0110 14-6883-0110 14-6892-6000 17500M BC300P (R) 17500S-2 BC300P (R)	
FUSELAGE - ATA 53	
04-6001-1100 04-6029-5111 04-6029-5111-A5	

General Atomics	
Avenger (Predator C)	
TOWING & TAXIING - ATA 9	
ETT-8X	
TTR-6	
TTR-8	

MQ-1, MQ-9 (Predator B)	
LIFTING & SHORING - ATA 7	
02-0234-0111	
R-1117 (R)	
02-7947C0000	
TOWING & TAXIING - ATA 9	
01-1308-0011	
K-4499	
ETT-8X	
TTR-6	
TTR-8	
LANDING GEAR - ATA 32	
14-6801-0120	
Z-1063-08 (R)	
Z-1063-10 (R)	

General Dynamics	
Convair 580, 600, 640	
LIFTING & SHORING - ATA 7	
02A7850C0100 Main (2)	
02A1256C0111 Tail	
02-7813C0100 Axle	
02-7947C0000	
TOWING & TAXIING - ATA 9	
01-1201-0010	
01-0547-0000 (R)	
01-1216-0000	
01-0547-0000 (R)	
01-1950-5000	
01-1954-6000	
01-1954-6002	
ETT-8X	
ETT-12X	
TTR-6	
TTR-8	
PARKING & MOORING - ATA 10	
99-9028-6000	
SERVICING - ATA 12	
ENGINE OIL	
06-5010-6800	
06-5022-6800	
06-5042-0800	
LAVATORY	
10-6402-0010	
K-2029 (R)	
K-2410 (R)	
10-6403-6000	
10-6412-0000	
K-2029 (R)	
K-2410 (R)	
POTABLE WATER	
19-4305-0000	
19-4306-0000	
K-2411	
NITROGEN	
18-4201-1010	
K-1225	
18-4208-0010	
18-4303-0000	
18-4315-0000	
18-4318-0000	
PC-1107	
K-3706	
OXYGEN	
20-4500-7000	
20-4502-6000	
20-4504-7000	
20-4505-7000	
20-4523-0000	
20-4525-0000	
PC-1006	
PC-1009	
PC-1124	
ELECTRICAL POWER - ATA 24	
11-2820-0000	
11-6610-6000	
112850	
112860	
FUEL - ATA 28	
07-3000-1921	
07-3006-6900	
HYDRAULIC POWER - ATA 29	
5411-ZZ (base model)	
ICE & RAIN PROTECTION - ATA 30	
09-6200-0010	

LANDING GEAR - ATA 32	
14-6801-0120	
Z-3072-20 Main (R)	
Z-1063-17 Nose (R)	
14-6802-6000	
14-6804-6000	
14-6805-6010	
14-6806-6011	
14-6807-6011	
14-6808-6000	
14-6830-6012	
14-6878-0110	
14-6883-0110	
14-6892-6000	
FUSELAGE - ATA 53	
04-6028C0121	
K-3057 Crane Hook (R)	
Z-4082 Lift Tray (R)	
04-6029-5111	
04-6029-5111-A5	
04-6152-0120	
K-2012 Gooseneck Boom Kit	
K-2013 Pneumatic Pump Kit	
K-2953 Hand Winch Kit	
POWER PLANT - ATA 71	
08-4049-0013	

Grob	
G120A, G120TB	
LIFTING & SHORING - ATA 7	
02-0520C0111 Nose	
02-0517C0140 Main (2) - G120A	
02-0520C0111 Main (2) - G120TP	
02-7947C0000	
TOWING & TAXIING - ATA 9	
01-1333-0000	
ETT-8X	
TTR-6	
TTR-8	
PARKING & MOORING - ATA 10	
99-9028-6000	
SERVICING - ATA 12	
HYDRAULIC FLUID	
06-5004C0500	
06-5022-6500	
06-5042-0500	
NITROGEN	
12-3100-1000	
12-3103-6011	
18-4201-1010	
18-4208-0010	
18-4303-0000	
18-4315-0000	
18-4318-0000	
PC-1107	
K-3706	
OXYGEN	
12-3100-1000	
20-4500-7000	
20-4502-6000	
20-4504-7000	
20-4505-7000	
20-4523-0000	
20-4525-0000	
PC-1006	
PC-1124	
ELECTRICAL POWER - ATA 24	
112850S0100	
FUEL - ATA 28	
07-3000-1921	
07-3006-6900	
LANDING GEAR - ATA 32	
14-6802-6000	
14-6804-6000	
14-6806-6011	
14-6807-6011	
14-6808-6000	
14-6833-6030	
14-6892-6000	
G120A only:	
14-4039-0010	
14-6801-0120	
Z-1063-09 Main (R)	
Z-1063-07 Nose (R)	
14-6900-6600	
G120TP only:	
14-6801-0120	
Z-1063-13 Main (R)	
Z-1063-09 Nose (R)	
14-6805-6010	
POWER PLANT - ATA 71	
08-4048-0013 - G120A only	

For detailed model information reference the items page(s) • Bracketed # = quantity • R = required

Gulfstream	
Aero Commander	
LIFTING & SHORING - ATA 7	
02-0234-0111 Main (2) 03-5400-0000 (2) (R) 02-7813C0100 Axle 02-7947C0000	
TOWING & TAXIING - ATA 9	
01-1202-0000 01-0511-0000 (R) 01-1112-0010 01-1954-6000 01-1954-6002 eJP-3 eJP-3L	
AIR CONDITIONING - ATA 21	
15-7601-6000 15_7603-1000 (base model) 15-7605-6010	
ELECTRICAL POWER - ATA 24	
11-2820-0000	
HYDRAULIC POWER - ATA 29	
5010-AR (base model) 50111ZZG KHC-1038	
LANDING GEAR - ATA 32	
14-6909C0000	

Turbo Commander	
LIFTING & SHORING - ATA 7	
02-0566C0110 Main (2) 02-7813C0100 Axle 02-7947C0000	
TOWING & TAXIING - ATA 9	
01-1202-0000 01-0511-0000 (R) 01-1112-0010 01-1954-6000 01-1954-6002 ETT-8X TTR-6 TTR-8	
ELECTRICAL POWER - ATA 24	
11-2820-0000	
HYDRAULIC POWER - ATA 29	
5010-AR (base model) 50111ZZG KHC-1038	
LANDING GEAR - ATA 32	
14-6909C0000	

GI	
LIFTING & SHORING - ATA 7	
02-1248C0112 Main (2) 02-1036C0111 Nose 02-7813C0100 Axle 02-7947C0000	
TOWING & TAXIING - ATA 9	
01-1202-0000 01-0546-0000 (R) 01-1290-0100 01-0546-0000 (R) 01-1106-0000 01-1954-6000 01-1954-6002 ETT-8X TTR-6 TTR-8	
ELECTRICAL POWER - ATA 24	
11-2820-0000	
HYDRAULIC POWER - ATA 29	
5030-AD (base model) KHC-1007	
LANDING GEAR - ATA 32	
14-6909C0000	

Gulfstream		
G100 (Astra SPX)		
LIFTING & SHORING - ATA 7		LANDING GEAR - ATA 32
02-0536C0110 Main (2) 02-0536C0110 Nose 02-7813C0100 Axle 02-7947C0000 03A5809C0000 Stabilizing Stand		14-6801-0120 Z-1063-14 Main (R) Z-1063-11 Nose (R) 14-6802-6000 14-6804-6000 14-6805-6010 14-6806-6011 14-6807-6011 14-6808-6000 14-6883-0110 14-6892-6000 14-6909C0000 14-6915-0100
TOWING & TAXIING - ATA 9		FUSELAGE - ATA 53
01-1202-0000 01-0559-0000 (R) 01-1215-0000 01-0559-0000 (R) 01-1262-0000 01-1950-5000 01-1954-6000 01-1954-6002		04-6028C0121 K-3057 Crane Hook (R) Z-4082 Lift Tray (R) 04-6029-5111 04-6029-5111-A5 04-6150-0120 K-2012 Gooseneck Boom Kit K-2013 Pneumatic Pump Kit K-2953 Hand Winch Kit
PARKING & MOORING - ATA 10		POWER PLANT - ATA 71
99-9028-6000		08-0102-4010 08-2001-0000 K-2112 (R) TFE731-3 08-2021C0000 K-3215 (R) TFE731-40 08-2034-0010 K-2808 (R) TFE731-40 08-4049-0013
SERVICING - ATA 12		
ENGINE OIL		
06-5009C6800 06-5010-6800 06-5022-6800		
HYDRAULIC FLUID		
06-4005-3611 06-4035-3600 06-5022-6600 06-5041-3610 06-5042-3600		
LAVATORY		
10-4036-0010 K-2029 (R) K-2410 (R) 10-6408-0000 K-2412 (R) 10-6412-0000 K-2029 (R) K-2410 (R) 10-6409-0000		
POTABLE WATER		
19-4305-0000 19-4306-0000 K-2411		
NITROGEN		
18-4200-1100 K-1225 18-4208-0010 18-4303-0000 18-4315-0000 18-4318-0000 PC-1107 K-3706		
OXYGEN		
20-4500-7000 20-4502-6000 20-4504-7000 20-4505-7000 20-4523-0000 20-4525-0000 PC-1006 PC-1124		
AIR CONDITIONING - ATA 21		
15_7603-1000 (base model) 15-7605-6010		
ELECTRICAL POWER - ATA 24		
11-2820-0000 11-6610-6000		
FUEL - ATA 28		
07-3000-1921 07-3001-4900		
HYDRAULIC POWER - ATA 29		
5431-BH (base model) KHC-1342 KHC-4024		
ICE & RAIN PROTECTION - ATA 30		
09-6200-0010		

Gulfstream	
G150	
LIFTING & SHORING - ATA 7	ICE & RAIN PROTECTION - ATA 30
02-1032C0111 Main (2) 02-7856C0100 Nose 02-7813C0100 Axle 02-7947C0000 03A5809C0000 Stabilizing Stand	09-6200-0010
TOWING & TAXIING - ATA 9	LANDING GEAR - ATA 32
01-1202-0000 01-0576-0000 (R) 01-1215-0000 01-0576-0000 (R) 01-1290-0100 01-0576-0000 (R) 01-1354-0100 01-1954-6000 01-1954-6002 ETT-8X TTR-6 TTR-8	14-6801-0120 Z-1063-14 Main (R) Z-1063-11 Nose (R) 14-6802-6000 14-6804-6000 14-6805-6010 14-6806-6011 14-6807-6011 14-6808-6000 14-6883-0110 14-6892-6000 14-6909C0000 14-6915-0100
PARKING & MOORING - ATA 10	FUSELAGE - ATA 53
99-9028-6000	04-6028C0121 K-3057 Crane Hook (R) Z-4082 Lift Tray (R)
SERVICING - ATA 12	04-6029-5111 04-6029-5111-A5 04-6150-0120
ENGINE OIL	K-2012 Gooseneck Boom Kit K-2013 Pneumatic Pump Kit K-2953 Hand Winch Kit
06-5009C6800 06-5010-6800 06-5022-6800	POWER PLANT - ATA 71
HYDRAULIC FLUID	08-0102-4010 08-2001-0000 08-2021C0000 K-3215 (R) TFE731-40 08-2034-0010 K-2808 (R) TFE731-40 08-4049-0013 08-2034-0010 K-2808 (R) TFE731-40 08-4049-0013
06-4005-3611 06-4035-3600 06-5022-6600 06-5041-3610 06-5042-3600	
LAVATORY	
10-4036-0010 K-2410 (R) K-2412 (R) 10-6408-0000 K-2410 (R) K-2412 (R) 10-6412-0000 K-2410 (R) K-2412 (R) 10-6409-0000	
POTABLE WATER	
19-4305-0000 19-4306-0000 K-2411	
NITROGEN	
18-4200-1100 K-1225 18-4208-0010 18-4303-0000 18-4315-0000 18-4318-0000 PC-1107 K-3706	
OXYGEN	
20-4500-7000 20-4502-6000 20-4504-7000 20-4505-7000 20-4523-0000 20-4525-0000 PC-1006 PC-1124	
AIR CONDITIONING - ATA 21	
15_7603-1000 (base model) 15-7605-6010	
ELECTRICAL POWER - ATA 24	
11-6610-6000	
FUEL - ATA 28	
07-3000-1921 07-3001-4900	
HYDRAULIC POWER - ATA 29	
5431-BH (base model) KHC-1342 KHC-4024	

Gulfstream	
G200 (Galaxy)	
LIFTING & SHORING - ATA 7	HYDRAULIC POWER - ATA 29
02-1032C0111 Main (2) 02-7828C0110 Nose 02-7813C0100 Axle 02-7947C0000	(base models) 54311-BH_EKQU4 50 hz countries 54311-BH_FKQU4 60 hz countries KHC-1342 KHC-4024 06-5051-6600 K-2340 (R)
TOWING & TAXIING - ATA 9	ICE & RAIN PROTECTION - ATA 30
01-1271-0000 01-1272-0000 01-1354-0100 01-1950-5000 eJP-10 eJP-12 ETT-8X ETT-12X TTR-6 TTR-8	09-6200-0010
PARKING & MOORING - ATA 10	LANDING GEAR - ATA 32
99-9015-6000 99-9045-9000	14-6801-0120 Z-1063-17 Main (R) Z-1064-13 Nose (R) 14-6802-6000 14-6804-6000 14-6805-6010 14-6806-6011 14-6807-6011 14-6808-6000 14-6830-6012 14-6883-0110 14-6892-6000 14-6909C0000 14-6915-0100 14-6918-0600 06-5076-9400
SERVICING - ATA 12	FUSELAGE - ATA 53
ENGINE OIL	04-6028C0121 K-3057 Crane Hook (R) Z-4082 Lift Tray (R)
06-5009C6800 06-5010-6800 06-5022-6800	04-6029-5111 04-6029-5111-A5 04-6150-0120
HYDRAULIC FLUID	K-2012 Gooseneck Boom Kit K-2013 Pneumatic Pump Kit K-2953 Hand Winch Kit
06-4005-3611 06-4035-3600 06-5022-6600 06-5042-3600	POWER PLANT - ATA 71
LAVATORY	08-0102-4010 08-2001-0000 08-2021C0000 K-3215 (R) TFE731-40 08-2034-0010 K-2808 (R) TFE731-40 08-4049-0013 08-2034-0010 K-2808 (R) TFE731-40 08-4049-0013
10-4036-0010 K-2410 (R) K-2412 (R) 10-6408-0000 K-2410 (R) K-2412 (R) 10-6412-0000 K-2410 (R) K-2412 (R) 10-6409-0000	08-0138-7000 08-2034-0010 K-3152 (R) PW306A 08-4049-0013
POTABLE WATER	
19-4305-0000 19-4306-0000 K-2411	
NITROGEN	
18-4200-1100 K-1225 18-4208-0010 18-4303-0000 18-4315-0000 18-4318-0000 PC-1107 K-3706	
OXYGEN	
20-4500-7000 20-4502-6000 20-4504-7000 20-4505-7000 20-4523-0000 20-4525-0000 PC-1006 PC-1124	
AIR CONDITIONING - ATA 21	
15_7603-1000 (base model) 15-7605-6010	
ELECTRICAL POWER - ATA 24	
11-6610-6000 112850 112860	
FUEL - ATA 28	
07-3000-1921 07-3006-6900	

For detailed model information reference the items page(s) • Bracketed # = quantity • R = required

Gulfstream	
G280	
LIFTING & SHORING - ATA 7	HYDRAULIC POWER - ATA 29
02A7917C0100 Main (2)	(base models)
02A7828C0110 Nose	54311-BH_EKQU4 50 hz countries
02A7899C0100 Main (2) alternate if no flat strut	54311-BH_FKQU4 (60 hz countries)
02-1032C0111 Main (2)	KHC-1342
aircraft not to exceed 35,750 lbs	KHC-4024
02A7917C0100 Nose alternate	KHC-4053
02-7813C0100 Axle	06-5051-6600
TOWING & TAXIING - ATA 9	K-2340 (R)
01-1272-0000	ICE & RAIN PROTECTION - ATA 30
01-1354-0100	09-6200-0010
eJP-10	LANDING GEAR - ATA 32
eJP-12	14-6801-0120
ETT-8X	Z-1063-17 Main (R)
ETT-12X	Z-1064-13 Nose (R)
TTR-6	14-6804-6000
TTR-8	14-6805-6010
PARKING & MOORING - ATA 10	14-6806-6011
99-4099-6000	14-6807-6011
99-7100-6000	14-6918-0600
99-7101-6000	06-5076-9400
99-7102-6000	FUSELAGE - ATA 53
99-7103-6000	04-6028C0121
99-7104-6000	04-6029-5111
99-7105-6000	04-6029-5111-A5
99-7106-6000	
99-7107-6000	
99-7108-6000	
99-7109-6000	
99-7110-6000	
99-7111-6000	
99-9028-6000	
99-9045-9000	
SERVICING - ATA 12	
ENGINE OIL	
06-5022-6800	
06-5024-3510	
06-5042-0800	
HYDRAULIC FLUID	
06-5004C3600	
06-5024-3610	
06-5042-3600	
LAVATORY	
10-4036-0010	
10-6403-6000	
10-6409-0000	
POTABLE WATER	
19-4305-0000	
19-4306-0000	
K-2411	
H-2217	
NITROGEN	
12-3100-1000	
12-3104-0000	
18-4200-1100	
18-4208-0010	
18-4303-0000	
18-4315-0000	
18-4318-0000	
PC-1107	
OXYGEN	
12-3100-1000	
12-3104-0000	
20-4505-7000	
20-4523-0000	
PC-1006	
PC-1124	
AIR CONDITIONING - ATA 21	
15-7601-6000	
15_7603-1000 (base model)	
15-7605-6010	
ELECTRICAL POWER - ATA 24	
112860S0100	
112860S0200	
FUEL - ATA 28	
07-3009-6900	

Gulfstream	
G350, GII, GIII, GIV, GIVSP	
LIFTING & SHORING - ATA 7	HYDRAULIC POWER - ATA 29
02A7844C0111 Main (2)	(base models)
02A1248C0112 Nose	54311-EE_CEKQY4 50 hz countries
02-7830C0110 Axle	54311-EE_CFKQY4 60 hz countries
02-7947C0000	KHC-1008
TOWING & TAXIING - ATA 9	KHC-4025
01-1270-0010	06-5051-6600
01-0806-0010 (R)	K-2340 (R)
01-1290-0100	ICE & RAIN PROTECTION - ATA 30
01-0806-0000 (R)	09-6200-0010
01-1274-0030	LANDING GEAR - ATA 32
ETT-8X	14B6801-0120
ETT-12X	Z-3072-20 Main (R) Goodyear
TTR-6	Z-3072-22 Main (R) Dunlop
TTR-8	Z-1064-13 (R) Dunlop
TTR-12	14-6802-6000
PARKING & MOORING - ATA 10	14-6804-6000
99-9028-6000	14-6805-6010
99-9045-9000	14-6806-6011
SERVICING - ATA 12	14-6807-6011
ENGINE OIL	14-6808-6000
06-5009C6800	14-6830-6012
06-5010-6800	14-6878-0110
06-5022-6800	14-6883-0110
06-5043-1800	14-6892-6000
06-5073-0800	14-6909C0000
KHC-2173 (R)	14-6918-0600
HYDRAULIC FLUID	14-6923-0110
06-4005-3611	06-5076-9400
06-4035-3600	FUSELAGE - ATA 53
06-5022-6600	04-6005-1100
06-5042-3600	04-6028C0121
06-5043-3600	K-3057 Crane Hook (R)
LAVATORY	Z-4082 Lift Tray (R)
10-4036-0010	04-6029-5111
K-2410 (R)	04-6029-5111-A5
K-2412 (R)	04-6152-0120
10-6408-0000	K-2012 Gooseneck Boom Kit
K-2410 (R)	K-2013 Pneumatic Pump Kit
K-2412 (R)	K-2953 Hand Winch Kit
10-6409-0000	POWER PLANT - ATA 71
10-6412-0000	08-4049-0013
K-2029 (R)	
POTABLE WATER	
19-4305-0000	
19-4306-0000	
K-2411	
NITROGEN	
18-4201-1010	
K-1225	
18-4208-0010	
18-4303-0000	
18-4315-0000	
18-4318-0000	
PC-1107	
K-3706	
OXYGEN	
20-4500-7000	
20-4502-6000	
20-4504-7000	
20-4505-7000	
20-4523-0000	
20-4525-0000	
PC-1006	
PC-1124	
AIR CONDITIONING - ATA 21	
15_7603-1000 (base model)	
15-7605-6010	
ELECTRICAL POWER - ATA 24	
112850	
112860	
11-2820-0000	
11-4090-0000	
11-4290-0000	
11-6610-6000	
FUEL - ATA 28	
07-3000-1921	
07-3006-6900	

Gulfstream	
G450, G500, G550, G600, GV, GVSP	
LIFTING & SHORING - ATA 7	HYDRAULIC POWER - ATA 29
02A7844C0111 Main (2) 02A1248C0112 Nose 02-7830C0110 Axle 02-7947C0000	06-5051-6600 K-2340 (R) 673A
TOWING & TAXIING - ATA 9	G450, G550 only: (base models) 56311AE_U47 57311AE_U47 57311EE_CY47 split system KHC-1008 KHC-4025
01-1270-0010 01-0806-0010 (R) 01-1290-0100 01-0806-0000 (R) 01-1261-0000 01-1274-0030 01-1954-6000 01-1954-6002 eJP-10 eJP-12 ETT-8X ETT-12X TTR-6 - G450/G500 only TTR-8 TTR-12	G500, G600 only: TADHPU-5GS KHC-1008 KHC-4075
PARKING & MOORING - ATA 10	AGE170174A G500, G650 only
99-9028-6000 99-9045-9000	ICE & RAIN PROTECTION - ATA 30
SERVICING - ATA 12	09-6200-0010
ENGINE OIL	LANDING GEAR - ATA 32
06-5009C6800 06-5010-6800 06-5022-6800 06-5042-0800 06-5073-0800 KHC-2173 (R)	06-5076-9400 14-6802-6000 14-6804-6000 14-6805-6010 14-6806-6011 14-6807-6011 14-6808-6000 14-6830-6012 14-6878-0110 K-3151 (R) 14-6883-0110 K-2965 (R) 14-6892-6000 14-6909C0000 14-6918-0600 14-6919-0110
HYDRAULIC FLUID	FUSELAGE - ATA 53
06-4005-3611 06-4035-3600 06-5022-6600 06-5042-3600 06-5043-3600	04-6001-1100 04-6005-1100 04-6028C0121 K-3057 Crane Hook (R) K-4400 Lift Tray (R) 04-6029-5111 04-6029-5111-A5 04-6030-5111 04-6152-0120 K-2012 Gooseneck Boom Kit K-2013 Pneumatic Pump Kit K-2953 Hand Winch Kit
LAVATORY	
10-6403-6000 10-6410-0000 K-2029 (R) K-2410 (R) 10-6412-0000 K-2029 (R) K-2410 (R)	
POTABLE WATER	
19-4305-0000 19-4306-0000 K-2411	
NITROGEN	
18-4201-1010 K-1225 18-4208-0010 18-4303-0000 18-4315-0000 18-4318-0000 PC-1107 K-3706	
OXYGEN	
20-4500-7000 20-4502-6000 20-4504-7000 20-4505-7000 20-4523-0000 20-4525-0000 PC-1006 PC-1124	
AIR CONDITIONING - ATA 21	
15_7603-1000 (base model) 15-7605-6010	
ELECTRICAL POWER - ATA 24	
11-2820-0000 11-4090-0000 11-4290-0000 11-6610-6000 112850 112860	
FUEL - ATA 28	
07-3000-1921 07-3006-6900	

Gulfstream	
G650, G650ER, G700	
LIFTING & SHORING - ATA 7	HYDRAULIC POWER - ATA 29
02A7913C0100 Main (2) 02A1248C0112 Nose(2) 02-7925C0100 Axle 02-7947C0000	TADHPU-5GS KHC-1008 KHC-4075 13-6615-6000 AGE17074A KHC-3559 06-5051-6600 K-2340 (R)
TOWING & TAXIING - ATA 9	ICE & RAIN PROTECTION - ATA 30
01-1270-0010 01-0806-0010 (R) 01-1290-0100 01-0806-0000 (R) 01-1398C0000 01-1274-0030 01-1954-6000 01-1954-6002 eJP-10 eJP-12 ETT-8X ETT-12X TTR-8 TTR-12	09-6200-0010
PARKING & MOORING - ATA 10	LANDING GEAR - ATA 32
99-9028-6000 99-9045-9000	14-6802-6000 14-6804-6000 14-6805-6010 14-6806-6011 14-6807-6011 14-6808-6000 14-6830-6012 14-6878-0110 K-3151 (R) 14-6883-0110 K-2965 (R) 14-6892-6000 14-6909C0000 14-6918-0600 14-6919-0110
SERVICING - ATA 12	FUSELAGE - ATA 53
ENGINE OIL	04-6001-1100 04-6005-1100 04-6028C0121 K-3057 Crane Hook (R) K-4400 Lift Tray (R) 04-6029-5111 04-6029-5111-A5 04-6030-5111 04-6152-0120 K-2012 Gooseneck Boom Kit K-2013 Pneumatic Pump Kit K-2953 Hand Winch Kit
06-5009C6800 06-5010-6800 06-5022-6800 06-5042-0800 06-5073-0800 KHC-2173 (R)	
HYDRAULIC FLUID	
06-4005-3611 06-4035-3600 06-5022-6600 06-5042-3600 06-5043-3600	
LAVATORY	
10-6403-6000 10-6410-0000 K-2029 (R) K-2410 (R) 10-6412-0000 K-2029 (R) K-2410 (R)	
POTABLE WATER	
19-4305-0000 19-4306-0000 K-2411	
NITROGEN	
18-4201-1010 K-1225 18-4208-0010 18-4303-0000 18-4315-0000 18-4318-0000 PC-1107 K-3706	
OXYGEN	
20-4500-7000 20-4502-6000 20-4504-7000 20-4505-7000 20-4523-0000 20-4525-0000 PC-1006 PC-1124	
AIR CONDITIONING - ATA 21	
15_7603-1000 (base model) 15-7605-6010	
ELECTRICAL POWER - ATA 24	
112850 112860 11-2820-0000 11-4090-0000 11-4290-0000 11-6610-6000	
FUEL - ATA 28	
07-3000-1921 07-3006-6900	

For detailed model information reference the items page(s) • Bracketed # = quantity • R = required

Hawker Beechcraft
Beech Baron
LIFTING & SHORING - ATA 7
02-0222C0100 Main (2)
02-0300C0100
02-7947C0000
03-4006-0000 Stabilizing Stand
TOWING & TAXIING - ATA 9
01-1233-0010
eJP-3
eJP-3L
ETT-8X
TTR-6
TTR-8
ELECTRICAL POWER - ATA 24
11-2820-0000

Beech Bonanza
LIFTING & SHORING - ATA 7
02-0222C0100 Main (2)
02-0300C0100
02-7866-0100
02-7947C0000
03-4006-0000 Stabilizing Stand
TOWING & TAXIING - ATA 9
01-1233-0010
eJP-3
eJP-3L
ETT-8X
TTR-6
TTR-8
ELECTRICAL POWER - ATA 24
11-2820-0000

Hawker Beechcraft	
Beech 99, 1900	
LIFTING & SHORING - ATA 7	FUSELAGE - ATA 53
02-0536C0110 (3) 2 Main, 1 Nose	04-6028C0121
02-7856C0100 Hi-Float (3)	K-3057 Crane Hook (R)
2 Main, 1 Nose	Z-4082 Lift Tray (R)
02-7947C0000	04-6029-5111
03A5804C0010 Stabilizing Stand	04-6029-5111-A5
TOWING & TAXIING - ATA 9	04-6150-0120
01-1202-0000	K-2012 Gooseneck Boom Kit
01-0506-0000 (R)	K-2013 Pneumatic Pump Kit
01-1216-0000	K-2953 Hand Winch Kit
01-0506-0000 (R)	POWER PLANT - ATA 71
01-1109-0010	08-0102-4010
01-1259-0000	08-2001-0000
01-1950-5000	K-2116 (R)
01-1954-6000	08T4049-0013
01-1954-6002	K-1152 (R)
eJP-3	
eJP-3L	
ETT-8X	
TTR-6	
TTR-8	
PARKING & MOORING - ATA 10	
99-9028-6000	
SERVICING - ATA 12	
ENGINE OIL	
06-5009C6800	
06-5010-6800	
06-5022-6800	
06-5042-0800	
HYDRAULIC FLUID	
06-4005-0511	
06-4035-0500	
06-5010-6500	
06-5022-6500	
06-5042-0500	
NITROGEN	
18-4200-1100	
K-1225	
18-4208-0010	
18-4303-0000	
18-4315-0000	
18-4318-0000	
PC-1107	
K-3706	
OXYGEN	
20-4500-7000	
20-4502-6000	
20-4504-7000	
20-4505-7000	
20-4523-0000	
20-4525-0000	
PC-1006	
PC-1124	
AIR CONDITIONING - ATA 21	
15-7605-6010	
K-1285 (R)	
15_7603-1000 (base model)	
ELECTRICAL POWER - ATA 24	
11-2820-0000	
11-6610-6000	
112850	
112860	
FUEL - ATA 28	
07-3000-1921	
07-3001-4900	
ICE & RAIN PROTECTION - ATA 30	
09-4003-4010	
LANDING GEAR - ATA 32	
14-6801-0120	
Z-1063-11 Main (R)	
Z-1063-13 Nose (R)	
14-6802-6000	
14-6804-6000	
14-6805-6010	
14-6806-6011	
14-6807-6011	
14-6808-6000	
14-6883-0110	
14-6892-6000	

Hawker Beechcraft	
Beechjet 400A, Diamond	
LIFTING & SHORING - ATA 7	ICE & RAIN PROTECTION - ATA 30
02-7856C0100 (2) Main before SN RK-144: 02-0526C0110 Nose HJ-557 (3) (R) SN RK-144 and after : 02-0522C0141 Nose 02-7947C0000 03-4033-0000 Stabilizing Stand	09-6200-0010 LANDING GEAR - ATA 32
TOWING & TAXIING - ATA 9	14-6801-0120 Z-1063-13 Main (R) Z-1064-13 Nose (R) 14-6802-6000 14-6804-6000 14-6805-6010 14-6806-6011 14-6807-6011 14-6808-6000 14-6883-0110 14-6892-6000
01-1202-0000 01-0543-0000 (R) 01-1179-0010 01-1950-5000 01-1954-6000 01-1954-6002 eJP-3 eJP-3L ETT-8X TTR-6 TTR-8	FUSELAGE - ATA 53
PARKING & MOORING - ATA 10	04-6028C0121 K-3057 Crane Hook (R) Z-4082 Lift Tray (R) 04-6029-5111 04-6029-5111-A5 04-6150-0120 K-2012 Gooseneck Boom Kit K-2013 Pneumatic Pump Kit K-2953 Hand Winch Kit
99-9028-6000	POWER PLANT - ATA 71
SERVICING - ATA 12	08-0114-4010 08-2021C0000 K-1796 (R) 08-2030-0000 K-2776 (R) 08-4048-0013
ENGINE OIL	
06-5009C6800 06-5010-6800 06-5022-6800 06-5042-0800	
HYDRAULIC FLUID	
06-4005-0511 06-4035-0500 06-5022-6500 06-5042-0500	
LAVATORY	
10-4036-0010 K-2410 (R) K-2412 (R) 10-6408-0000 K-2410 (R) K-2412 (R) 10-6409-0000	
POTABLE WATER	
19-4305-0000 19-4306-0000 K-2411	
NITROGEN	
18-4200-1100 K-1225 18-4208-0010 18-4303-0000 18-4315-0000 18-4318-0000 PC-1107 K-3706	
OXYGEN	
20-4500-7000 20-4503-6000 20-4504-7000 20-4505-7000 20-4523-0000 20-4525-0000 PC-1006 PC-1124	
AIR CONDITIONING - ATA 21	
15-7605-6010 K-1660 (R) 15_7603-1000 (base model)	
ELECTRICAL POWER - ATA 24	
11-2820-0000 11-6610-6000 112850 112860	
FUEL - ATA 28	
07-3000-1921 07-3001-4900	
HYDRAULIC POWER - ATA 29	
5010-AA (base model) 50111ZZG KHC-1004 KHC-4020	

Hawker Beechcraft	
C-12, King Air	
LIFTING & SHORING - ATA 7	FUSELAGE - ATA 53
02-0536C0110 (3) 2 Main, 1 Nose 02-7856C0100 Hi-Float (3) 2 Main, 1 Nose 02-7947C0000 03A5804C0010 Stabilizing Stand	04-6028C0121 K-3057 Crane Hook (R) Z-4082 Lift Tray (R) 04-6029-5111 04-6029-5111-A5 04-6150-0120 K-2012 Gooseneck Boom Kit K-2013 Pneumatic Pump Kit K-2953 Hand Winch Kit
TOWING & TAXIING - ATA 9	PROPELLERS - ATA 61
01-1202-0000 01-0506-0000 (R) 01-1216-0000 01-0506-0000 (R) 01-1109-0010 01-1259-0000 01-1950-5000 01-1954-6000 01-1954-6002 eJP-3 eJP-3L	08-2033C0000 K-5433 (R)
PARKING & MOORING - ATA 10	POWER PLANT - ATA 71
99-9028-6000	08-0100-4000 08-0102-4010 08-0103-4000 08-2001-0000 K-2115 (R) PT6A-1 to 36 K-2116 (R) PT6A-20, 21 & 60 08-2023-0010 K-2110 (R) 08T4049-0013 K-1152 (R)
SERVICING - ATA 12	
ENGINE OIL	
06-5009C6800 06-5010-6800 06-5022-6800 06-5042-0800	
HYDRAULIC FLUID	
06-4005-0511 06-4035-0500 06-5022-6500 06-5042-0500	
NITROGEN	
18-4200-1100 K-1225 18-4208-0010 18-4303-0000 18-4315-0000 18-4318-0000 PC-1107 K-3706	
OXYGEN	
20-4500-7000 20-4502-6000 20-4504-7000 20-4505-7000 20-4523-0000 20-4525-0000 PC-1006 PC-1124	
AIR CONDITIONING - ATA 21	
15_7603-1000 (base model) K-1285 (R) K-1359 (R) SN BB1347 and higher	
ELECTRICAL POWER - ATA 24	
11-2820-0000 11-6610-6000 112850 112860	
FUEL - ATA 28	
07-3000-1921 07-3006-6900	
ICE & RAIN PROTECTION - ATA 30	
09-4003-4010 09-6200-0010	
LANDING GEAR - ATA 32	
14-6801-0120 Z-1063-13 (R) 14-6802-6000 14-6804-6000 14-6805-6010 14-6806-6011 14-6807-6011 14-6808-6000 14-6883-0110 14-6892-6000	

For detailed model information reference the items page(s) • Bracketed # = quantity • R = required

Hawker Beechcraft
Denali
LIFTING & SHORING - ATA 7
02A0536C0110 (3) 2 Main, 1 Nose 02A0527C0140 (3) 2 Main, 1 Nose 02-7836C0110 Axle 02-7813C0100 Axle 03A5857C0000 Stabilizing Stand
TOWING & TAXIING - ATA 9
01-1109-0100 01-1202-0000 01-0506-0000 (R) 01-1259-0000 TTR-6 TTR-8
SERVICING - ATA 12
HYDRAULIC FLUID
06-4035-0800
LAVATORY
10-4036-0010 K-2410 K-2412
NITROGEN
18-4208-0010
OXYGEN
20-4500-7000
AIR CONDITIONING - ATA 21
15A7603-1000 K-2601
LANDING GEAR - ATA 32
14-6801-0120 Z-1063-11 (R) Nose Z-1063-13 (R) Main
FUSELAGE - ATA 53
04-6027-0110
PROPELLERS - ATA 61
08-2033C0000 K-5433 (R)
POWER PLANT - ATA 71
08-0102-4010 K-5257 (R) 08-2001-0000 K-5281 (R) 08-4048-0013 K-1243 (R)

Duke 60
LIFTING & SHORING - ATA 7
02-0222C0100 Main (2) 02-0222C0100 Nose K-2020 (R) 02-7947C0000
TOWING & TAXIING - ATA 9
01-1233-0010 eJP-3 eJP-3L ETT-8X TTR-6 TTR-8
AIR CONDITIONING - ATA 21
15-7605-6010 K-1456 (R)
ELECTRICAL POWER - ATA 24
11-2820-0000

Hawker Beechcraft	
Hawker 1000	
LIFTING & SHORING - ATA 7	LANDING GEAR - ATA 32
02-1032C0111 (2) Main 02-0544C0110 Tail 02-7813C0100 Axle 02-7947C0000	14-6801-0120 Z-1063-15 (R) Main Z-1064-12 (R) Nose 14-6802-6000 14-6804-6000 14-6805-6010 14-6806-6011 14-6807-6011 14-6808-6000 14-6883-0110 14-6892-6000
TOWING & TAXIING - ATA 9	FUSELAGE - ATA 53
01-1202-0000 01-0502-0000 (R) 01-0574-0010 (R) 01-1950-5000 01-1954-6000 01-1954-6002 ETT-8X TTR-6 TTR-8	04-6028C0121 K-3057 Crane Hook (R) Z-4082 Lift Tray (R) 04-6029-5111 04-6029-5111-A5 04-6152-0120 K-2012 Gooseneck Boom Kit K-2013 Pneumatic Pump Kit K-2953 Hand Winch Kit
PARKING & MOORING - ATA 10	POWER PLANT - ATA 71
99-9028-6000	08-0102-4010 08-0121-4010 08-2018-0000 08-2021C0000 K-1795 (R) K-2809 (R) 08-2030-0000 K-2770 (R) 08-4049-0013
SERVICING - ATA 12	
ENGINE OIL	
06-5009C6800 06-5010-6800 06-5022-6800 06-5042-0800	
HYDRAULIC FLUID	
06-4005-0511 06-4035-0500 06-5022-6500 06-5042-0500	
LAVATORY	
10-4036-0010 K-2029 (R) K-2410 (R) 10-6408-0000 K-2029 (R) K-2410 (R) 10-6409-0000	
POTABLE WATER	
19-4305-0000 19-4306-0000 K-2411	
NITROGEN	
18-4200-1100 K-1225 18-4208-0010 18-4303-0000 18-4315-0000 18-4318-0000 PC-1107 K-3706	
OXYGEN	
20-4500-7000 20-4502-6000 20-4504-7000 20-4505-7000 20-4523-0000 20-4525-0000 PC-1006 PC-1124	
AIR CONDITIONING - ATA 21	
15_7603-1000 (base model) K-2610 (R) 15-7605-6010 K-2610 (R)	
ELECTRICAL POWER - ATA 24	
11-2820-0000 11-6610-6000 112850 112860	
FUEL - ATA 28	
07-3000-1921 07-3001-4900	
HYDRAULIC POWER - ATA 29	
5110-AB (base model) KHC-1005 KHC-4020	

Hawker Beechcraft	
Hawker 4000 (Horizon)	
LIFTING & SHORING - ATA 7	ICE & RAIN PROTECTION - ATA 30
02-1032C0111 (2) Main	09-6200-0010
02-1032C0111 Tail	LANDING GEAR - ATA 32
02-7813C0100 Axle	14-6801-0120
02-7947C0000	Z-1063-17 (R) Main
TOWING & TAXIING - ATA 9	Z-1064-17 (R) Nose
01-1202-0000	14-6802-6000
01-0571-0011 (R)	14-6804-6000
01-0603-0000 (R)	14-6805-6010
01-1216-0000	14-6806-6011
01-0571-0011 (R)	14-6807-6011
01-0603-0000 (R)	14-6808-6000
01-1229-0011	14-6883-0110
01-1954-6000	14-6892-6000
01-1954-6002	FUSELAGE - ATA 53
ETT-8X	04-6001-1100
TTR-6	04-6005-1100
TTR-8	04-6029-5111
PARKING & MOORING - ATA 10	04-6029-5111-A5
99-9028-6000	04-6033-0100
SERVICING - ATA 12	Z-4082 Lift Tray (R)
ENGINE OIL	04-6152-0120
06-5010-6800	K-2012 Gooseneck Boom Kit
06-5022-6800	K-2013 Pneumatic Pump Kit
06-5042-0800	K-2953 Hand Winch Kit
HYDRAULIC FLUID	POWER PLANT - ATA 71
06-4005-0511	08-0144-4000
06-4035-0500	08-2034-0010
06-5022-6500	K-3618 (R)
06-5042-0500	08-4049-0013
LAVATORY	TBD (R)
10-4036-0010	
K-2410 (R)	
K-2412 (R)	
10-6408-0000	
K-2410 (R)	
K-2412 (R)	
POTABLE WATER	
19-4305-0000	
K-2411	
NITROGEN	
12-3100-1000	
12-3103-6011	
12-3104-0000	
18-4201-1010	
K-1225	
18-4208-0010	
18-4303-0000	
18-4315-0000	
18-4318-0000	
PC-1107	
K-3706	
OXYGEN	
12-3100-1000	
12-3104-1000	
20-4500-7000	
20-4502-6000	
20-4504-7000	
20-4505-7000	
20-4523-0000	
20-4525-0000	
PC-1006	
PC-1124	
K-3337	
AIR CONDITIONING - ATA 21	
15_7603-1000 (base model)	
K-2610 (R)	
15-7605-6010	
K-2610 (R)	
ELECTRICAL POWER - ATA 24	
11-6610-6000	
112850	
112860	
FUEL - ATA 28	
07-3000-1921	
HYDRAULIC POWER - ATA 29	
5J11-EB (base model)	
5J11-C (base model) Split	
KHC-1005	
KHC-4020	

Hawker Beechcraft	
HS-125-800/850/900 Series	
LIFTING & SHORING - ATA 7	LANDING GEAR - ATA 32
02-1032C0111 (2) Main	14-6801-0120
02-0544C0110 Tail	Z-1063-15 (R) Main
02-7813C0100 Axle	Z-1064-12 (R) Nose
02-7947C0000	14-6802-6000
03-5830-0000 Pylon Support	14-6804-6000
TOWING & TAXIING - ATA 9	14-6806-6011
01-1202-0000	14-6807-6011
01-0502-0000 (R)	14-6808-6000
01-0574-0010 (R)	14-6831-6010
01-1950-5000	14-6883-0110
01-1954-6000	14-6892-6000
01-1954-6002	FUSELAGE - ATA 53
eJP-3	04-6014-0010
eJP-3L	04-6028C0121
ETT-8X	K-3057 Crane Hook (R)
TTR-6	Z-4082 Lift Tray (R)
TTR-8	04-6029-5111
PARKING & MOORING - ATA 10	04-6029-5111-A5
99-9028-6000	04-6152-0120
SERVICING - ATA 12	K-2012 Gooseneck Boom Kit
ENGINE OIL	K-2013 Pneumatic Pump Kit
06-5009C6800	K-2953 Hand Winch Kit
06-5010-6800	POWER PLANT - ATA 71
06-5022-6800	08-0102-4010
06-5042-0800	08-0121-4010
HYDRAULIC FLUID	08-2018-0000
06-4005-0511	08-2021C0000
06-4035-0500	K-1795 (R)
06-5022-6500	K-2809 (R)
06-5042-0500	08-2030-0000
LAVATORY	K-2770 (R)
10-4036-0010	08-4049-0013
K-2029 (R)	
K-2410 (R)	
10-6408-0000	
K-2029 (R)	
K-2410 (R)	
10-6409-0000	
POTABLE WATER	
19-4305-0000	
19-4306-0000	
K-2411	
NITROGEN	
18-4200-1100	
K-1225	
18-4208-0010	
18-4303-0000	
18-4315-0000	
18-4318-0000	
PC-1107	
K-3706	
OXYGEN	
20-4500-7000	
20-4502-6000	
20-4504-7000	
20-4505-7000	
20-4523-0000	
20-4525-0000	
PC-1006	
PC-1124	
AIR CONDITIONING - ATA 21	
15_7603-1000 (base model)	
K-2610 (R)	
15-7605-6010	
K-2610 (R)	
ELECTRICAL POWER - ATA 24	
11-2820-0000	
11-6610-6000	
112850	
112860	
FUEL - ATA 28	
07-3000-1921	
07-3001-4900	
HYDRAULIC POWER - ATA 29	
5110-AB (base model)	
KHC-1005	
KHC-4020	
ICE & RAIN PROTECTION - ATA 30	
09-5046-6500	

For detailed model information reference the items page(s) • Bracketed # = quantity • R = required

Hawker Beechcraft	
Premier	
LIFTING & SHORING - ATA 7	FUSELAGE - ATA 53
02-7856C0100 (2) Main K-3692 (R)	04-6001-1100
02-7856C0100 Nose	04-6029-5111
02-7813C0100 Axle	04-6029-5111-A5
02-7947C0000	04-6150-0120
03A5800C0010 Tail Stand	K-2012 Gooseneck Boom Kit
	K-2013 Pneumatic Pump Kit
	K-2953 Hand Winch Kit
TOWING & TAXIING - ATA 9	POWER PLANT - ATA 71
01-1202-0000	08-0119-8000
01-0543-0000 (R)	08-2021C0000
01-1286-0000	K-2032 (R)
01-1954-6000	08-2220C0000
01-1954-6002	08-4049-0013
eJP-3	
eJP-3L	
ETT-8X	
TTR-6	
TTR-8	
PARKING & MOORING - ATA 10	
99-9028-6000	
SERVICING - ATA 12	
ENGINE OIL	
06-5010-6800	
06-5022-6800	
06-5042-0800	
HYDRAULIC FLUID	
06-4005-0511	
06-4035-0500	
06-5022-6500	
06-5042-0500	
LAVATORY	
10-4036-0010	
K-2410 (R)	
10-6408-0000	
K-2410 (R)	
10-6409-0000	
POTABLE WATER	
19-4305-0000	
19-4306-0000	
K-2411	
NITROGEN	
18-4200-1100	
18-4208-0010	
18-4303-0000	
18-4315-0000	
18-4318-0000	
PC-1107	
K-3706	
OXYGEN	
20-4500-7000	
20-4502-6000	
20-4504-7000	
20-4505-7000	
20-4523-0000	
20-4525-0000	
PC-1006	
PC-1124	
AIR CONDITIONING - ATA 21	
15_7603-1000 (base model)	
ELECTRICAL POWER - ATA 24	
11-2820-0000	
11-6610-6000	
112850	
112860	
FUEL - ATA 28	
07-3000-1921	
HYDRAULIC POWER - ATA 29	
5211-AA (base model)	
KHC-1004	
KHC-4020	
LANDING GEAR - ATA 32	
14-6801-0120	
Z-1063-13 Main (R)	
Z-1063-14 Nose (R)	
14-6802-6000	
14-6804-6000	
14-6805-6010	
14-6806-6011	
14-6807-6011	
14-6808-6000	
14-6892-6000	

Hawker Beechcraft	
T-1 Jayhawk	
LIFTING & SHORING - ATA 7	LANDING GEAR - ATA 32
02-1032C0111 (2) Main	14-6801-0120
02-0544C0110 Tail	Z-1063-15 (R) Main
02-7813C0100 Axle	Z-1064-12 (R) Nose
02-7947C0000	14-6802-6000
	14-6804-6000
	14-6805-6010
	14-6806-6011
	14-6807-6011
	14-6808-6000
	14-6883-0110
	14-6892-6000
TOWING & TAXIING - ATA 9	FUSELAGE - ATA 53
01-1202-0000	04-6014-0010
01-0502-0000 (R)	04-6028C0121
01-0574-0010 (R)	K-3057 Crane Hook (R)
01-1950-5000	Z-4082 Lift Tray (R)
01-1954-6000	04-6029-5111
01-1954-6002	04-6029-5111-A5
eJP-3	04-6152-0120
eJP-3L	K-2012 Gooseneck Boom Kit
ETT-8X	K-2013 Pneumatic Pump Kit
TTR-6	K-2953 Hand Winch Kit
TTR-8	
PARKING & MOORING - ATA 10	POWER PLANT - ATA 71
99-9028-6000	08-0102-4010
SERVICING - ATA 12	08-0121-4010
ENGINE OIL	08-2018-0000
06-5009C6800	08-2021C0000
06-5010-6800	K-1795 (R)
06-5022-6800	08-2030-0000
06-5042-0800	K-2770 (R)
HYDRAULIC FLUID	08-4049-0013
06-4005-0511	
06-4035-0500	
06-5022-6500	
06-5042-0500	
LAVATORY	
10-4036-0010	
K-2029 (R)	
K-2410 (R)	
10-6408-0000	
K-2029 (R)	
K-2410 (R)	
10-6409-0000	
POTABLE WATER	
19-4305-0000	
19-4306-0000	
K-2411	
NITROGEN	
18-4200-1100	
K-1225	
18-4208-0010	
18-4303-0000	
18-4315-0000	
18-4318-0000	
PC-1107	
K-3706	
OXYGEN	
20-4500-7000	
20-4502-6000	
20-4504-7000	
20-4505-7000	
20-4523-0000	
20-4525-0000	
PC-1006	
PC-1124	
AIR CONDITIONING - ATA 21	
15_7603-1000 (base model)	
K-2610 (R)	
ELECTRICAL POWER - ATA 24	
11-2820-0000	
11-6610-6000	
112850	
112860	
FUEL - ATA 28	
07-3000-1921	
07-3001-4900	
HYDRAULIC POWER - ATA 29	
5110-AB (base model)	
671A	
KHC-1005	
KHC-4020	
ICE & RAIN PROTECTION - ATA 30	
09-5046-6500	

Hawker Beechcraft	
T-400	
LIFTING & SHORING - ATA 7	LANDING GEAR - ATA 32
02-1032C0111 (2) Main 02-0544C0110 Tail 02-7813C0100 Axle 02-7947C0000 03-5830-0000 Pylon Support	14-6801-0120 Z-1063-15 (R) Main Z-1064-12 (R) Nose 14-6802-6000 14-6804-6000 14-6805-6010 14-6806-6011 14-6807-6011 14-6808-6000 14-6883-0110 14-6892-6000
TOWING & TAXIING - ATA 9	FUSELAGE - ATA 53
01-1202-0000 01-0502-0000 (R) 01-0574-0010 (R) 01-1950-5000 01-1954-6000 01-1954-6002 eJP-3 eJP-3L ETT-8X TTR-6 TTR-8	04-6014-0010 04-6028C0121 K-3057 Crane Hook (R) Z-4082 Lift Tray (R) 04-6029-5111 04-6029-5111-A5 04-6152-0120 K-2012 Gooseneck Boom Kit K-2013 Pneumatic Pump Kit K-2953 Hand Winch Kit
PARKING & MOORING - ATA 10	POWER PLANT - ATA 71
99-9028-6000	08-0102-4010 08-0121-4010 08-2018-0000 08-2021C0000 K-1795 (R) 08-2030-0000 K-2770 (R) 08-4049-0013
SERVICING - ATA 12	
ENGINE OIL	
06-5009C6800 06-5010-6800 06-5022-6800 06-5042-0800	
HYDRAULIC FLUID	
06-4005-0511 06-4035-0500 06-5022-6500 06-5042-0500	
LAVATORY	
10-4036-0010 K-2029 (R) K-2410 (R) 10-6408-0000 K-2029 (R) K-2410 (R) 10-6409-0000	
POTABLE WATER	
19-4305-0000 19-4306-0000 K-2411	
NITROGEN	
18-4200-1100 K-1225 18-4208-0010 18-4303-0000 18-4315-0000 18-4318-0000 PC-1107 K-3706	
OXYGEN	
20-4500-7000 20-4502-6000 20-4504-7000 20-4505-7000 20-4523-0000 20-4525-0000 PC-1006 PC-1124	
AIR CONDITIONING - ATA 21	
15_7603-1000 (base model) K-2610 (R)	
ELECTRICAL POWER - ATA 24	
11-2820-0000 11-6610-6000 112850 112860	
FUEL - ATA 28	
07-3000-1921 07-3001-4900	
HYDRAULIC POWER - ATA 29	
5110-AB (base model) KHC-1005 KHC-4020	
ICE & RAIN PROTECTION - ATA 30	
09-5046-6500	

Hawker Beechcraft
T-6A Texan II
LIFTING & SHORING - ATA 7
02-7838C0110 (2) Main 02-7838C0110 Tail 02-7852C0100 Axle 02-7947C0000 03-4006-0000 Nose Stabilizing Stand
TOWING & TAXIING - ATA 9
01-1202-0000 01-0595-0000 (R) 01-1273-0010 01-1283-0000 01-1954-6000 01-1954-6002 eJP-3 eJP-3L ETT-8X TTR-6 TTR-8
PARKING & MOORING - ATA 10
99-9028-6000
SERVICING - ATA 12
ENGINE OIL
06-5009C6800 06-5010-6800 06-5022-6800
HYDRAULIC FLUID
06-4005-0511 06-4035-0500 06-5022-6500
NITROGEN
12-3104-0000 18-4200-1100 K-1225 18-4208-0010 18-4303-0000 18-4315-0000 18-4318-0000 PC-1107 K-3706
OXYGEN
12-3104-0000 20-4501-7010 20-4502-6000 20-4504-7000 20-4505-7000 20-4523-0000 20-4525-0000 PC-1006 PC-1124
ELECTRICAL POWER - ATA 24
11-2820-0000 11-6610-6000 112850 112860
FUEL - ATA 28
07-3000-1921 07-3006-6900
HYDRAULIC POWER - ATA 29
51100AB1 51100AB3
ICE & RAIN PROTECTION - ATA 30
09-4003-4010
LANDING GEAR - ATA 32
14-6801-0120 Z-1063-11 (R) Main Z-1063-15 (R) Nose 14-6802-6000 14-6804-6000 14-6806-6011 14-6807-6011 14-6808-6000 14-6883-0110 14-6892-6000
FUSELAGE - ATA 53
04-6027-0110 04-6029-5111 04-6029-5111-A5 04-6150-0120 K-2012 Gooseneck Boom Kit K-2013 Pneumatic Pump Kit K-2953 Hand Winch Kit
POWER PLANT - ATA 71
08-4053-0013 08-4054-0010

Hawker Beechcraft
U-21
LIFTING & SHORING - ATA 7
02-0536C0110 (3) 2 Main, 1 Nose 02-7856C0100 Hi-Float (3) 2 Main, 1 Nose 02-7947C0000 03A5804C0010 Stabilizing Stand
TOWING & TAXIING - ATA 9
01-1202-0000 01-0506-0000 (R) 01-1216-0000 01-0506-0000 (R) 01-1109-0010 01-1954-6000 01-1954-6002 eJP-3 eJP-3L ETT-8X TTR-6 TTR-8
ELECTRICAL POWER - ATA 24
11-2820-0000

For detailed model information reference the items page(s) • Bracketed # = quantity • R = required

HondaJet	
HA-420	
LIFTING & SHORING - ATA 7	LANDING GEAR - ATA 32
02-0517C0140 Main (2)	14-4039-0010
02-0527C0140 Nose	14-6801-0120
02-7924C0100 Axle	Z-1063-12 (R)
03-5851-0000 Stabilizing Stand	Z-1064-11 (R)
TOWING & TAXIING - ATA 9	14-6802-6000
01-1202-0000	14-6804-6000
01-0607-0000 (R)	14-6805-6010
01-1353-0000	14-6806-6011-A1
01-1954-6000	14-6807-6011
01-1954-6002	14-6808-6000
eJP-3	14-6829-6000
eJP-3L	14-6830-6012
ETT-8X	14-6892-6000
TTR-6	14-6903-6000
TTR-8	FUSELAGE - ATA 53
PARKING & MOORING - ATA 10	04-6005-1100
99-9010-6000	04-6028C0121
99-9045-9000	04-6036-0100
SERVICING - ATA 12	04-6150-0120
ENGINE OIL	K-2012 Gooseneck Boom Kit
06-5022-6800	K-2013 Pneumatic Pump Kit
06-5042-0800	K-2953 Hand Winch Kit
HYDRAULIC FLUID	POWER PLANT - ATA 71
06-5022-6800	08-0134-4000
06-5042-0800	K-4337 (R)
LAVATORY	K-4344 (R)
10-4036-0010	08-2021C0000
K-2029 (R)	
K-2412 (R)	
K-4712 (R)	
10-6408-0000	
K-2029 (R)	
K-2412 (R)	
K-4712 (R)	
10-6409-0000	
NITROGEN	
12-3100-1000	
12-3103-6011	
18-4201-1010	
18-4208-0010	
18-4303-0000	
18-4315-0000	
18-4318-0000	
PC-1107	
K-3706	
OXYGEN	
12-3100-1000	
20-4500-7000	
20-4502-6000	
20-4504-7000	
20-4505-7000	
20-4523-0000	
20-4525-0000	
PC-1006	
PC-1124	
AIR CONDITIONING - ATA 21	
15_7608-0000 (base model)	
15-7605-6010	
ELECTRICAL POWER - ATA 24	
11-2820-0000	
11-6610-6000	
112850	
112860	
FUEL - ATA 28	
07-3006-6900	
07-3018-6900	
HYDRAULIC POWER - ATA 29	
5S41-CX (base model)	
5S411CX_E (50 hz countries)	
5S411CX_F (50 hz countries)	
KHC-4026	
KHC-4027	
KHC-4050	
06-5051-6500	
K-2339 (R)	

IAI	
Astra	
LIFTING & SHORING - ATA 7	LANDING GEAR - ATA 32
02-7856C0100 Main (2) 02-0536C0110 Nose 02-7947C0000 03A5809C0000 Stabilizing Stand	14-6801-0120 Z-1063-14 (R) Main Z-1063-13 (R) Nose
TOWING & TAXIING - ATA 9	14-6802-6000 14-6804-6000 14-6805-6010 14-6806-6011 14-6807-6011 14-6808-6000 14-6883-0110 14-6892-6000
01-1202-0000 01-0559-0000 (R) 01-1215-0000 01-0559-0000 (R) 01-1262-0000 01-1950-5000 01-1954-6000 01-1954-6002 eJP-3 eJP-3L ETT-8X TTR-6 TTR-8	FUSELAGE - ATA 53 04-6028C0121 K-3057 Crane Hook (R) Z-4082 Lift Tray (R) 04-6029-5111 04-6029-5111-A5 04-6150-0120 K-2012 Gooseneck Boom Kit K-2013 Pneumatic Pump Kit K-2953 Hand Winch Kit
PARKING & MOORING - ATA 10	POWER PLANT - ATA 71
99-9028-6000	08-0102-4010 08-0141-4000 08-0142-4000 08-2001-0000 K-2112 (R) 08-2021C0000 K-3215 (R) 08-2030-0000 K-2770 (R) 08-4049-0013
SERVICING - ATA 12	
ENGINE OIL	
06-5009C6800 06-5010-6800 06-5022-6800	
HYDRAULIC FLUID	
06-4005-3611 06-4035-3600 06-5022-6600 06-5041-3610 06-5042-3600	
LAVATORY	
10-4036-0010 K-2410 (R) K-2412 (R) 10-6408-0000 K-2410 (R) K-2412 (R) 10-6409-0000	
POTABLE WATER	
19-4305-0000 19-4306-0000 K-2411	
NITROGEN	
18-4200-1100 K-1225 18-4208-0010 18-4303-0000 18-4315-0000 18-4318-0000 PC-1107 K-3706	
OXYGEN	
20-4500-7000 20-4502-6000 20-4504-7000 20-4505-7000 20-4523-0000 20-4525-0000 PC-1006 PC-1124	
AIR CONDITIONING - ATA 21	
15_7603-1000 (base model) K-2601 (R)	
ELECTRICAL POWER - ATA 24	
11-2820-0000 11-6610-6000 112850 112860	
FUEL - ATA 28	
07-3000-1921 07-3001-4900	
ICE & RAIN PROTECTION - ATA 30	
09-6200-0010	

IAI	
Westwind 1 & 2	
LIFTING & SHORING - ATA 7	LANDING GEAR - ATA 32
02-0544C0110 Main (2) 02-7813C0110 Nose 02-7947C0000 03-4015-0000 Stabilizing Stand	14-6801-0120 Z-1063-13 (R) Main Z-1063-11 (R) Nose
TOWING & TAXIING - ATA 9	14-6802-6000 14-6804-6000 14-6805-6010 14-6806-6011 14-6807-6011 14-6808-6000 14-6883-0110 14-6892-6000
01-1202-0000 01-0559-0000 (R) 01-1262-0000 01-1950-5000 01-1954-6000 01-1954-6002 eJP-3 K-4052 (R) eJP-3L K-4052 (R) ETT-8X TTR-6 TTR-8	FUSELAGE - ATA 53 04-6028C0121 K-3057 Crane Hook (R) 04-6029-5111 04-6029-5111-A5 04-6150-0120 K-2012 Gooseneck Boom Kit K-2013 Pneumatic Pump Kit K-2953 Hand Winch Kit
PARKING & MOORING - ATA 10	POWER PLANT - ATA 71
99-9028-6000	08-0102-4010 08-2021C0000 K-1795 (R) 08-2030-0000 K-2770 (R) 08-4049-0013
SERVICING - ATA 12	
ENGINE OIL	
06-5009C6800 06-5010-6800 06-5022-6800	
HYDRAULIC FLUID	
06-4005-0511 06-4035-0500	
HYDRAULIC FLUID	
06-4005-3611 06-4035-3600 06-5022-6600 06-5042-3600	
LAVATORY	
10-4036-0010 K-2410 (R) K-2412 (R) 10-6408-0000 K-2410 (R) K-2412 (R) 10-6409-0000	
POTABLE WATER	
19-4305-0000 19-4306-0000 K-2411	
NITROGEN	
18-4200-1100 18-4208-0010 18-4303-0000 18-4315-0000 18-4318-0000 PC-1107 K-3706	
OXYGEN	
20-4500-7000 20-4502-6000 20-4504-7000 20-4505-7000 20-4523-0000 20-4525-0000 PC-1006 PC-1124	
AIR CONDITIONING - ATA 21	
15_7603-1000 (base model) K-2418 (R) 15-7605-6010 K-2418 (R)	
ELECTRICAL POWER - ATA 24	
11-2820-0000 11-6610-6000 112850 112860	
FUEL - ATA 28	
07-3000-1921 07-3006-6900	
HYDRAULIC POWER - ATA 29	
5130-AP (base model) KHC-1017	

For detailed model information reference the items page(s) • Bracketed # = quantity • R = required

Leonardo (AgustaWestland)
A109A, A109C, A109E, A109S, Grand New
LIFTING & SHORING - ATA 7
02A7898C0100 (2) Main R-1187-01 (R)
02A7898C0100 Nose R-1187-02 (R)
02-7947C0000
TOWING & TAXIING - ATA 9
01-1202-0000 01-0524-0000 (R)
01-1154-0000
01-1954-6000
01-1954-6002
ETT-8X
TTR-6
TTR-8
ELECTRICAL POWER - ATA 24
11-2820-0000 112850 112860
HYDRAULIC POWER - ATA 29
5110-FR (base model) 5110-C Split System KHC-2257

AW139 (AB139), MH-139A
LIFTING & SHORING - ATA 7
02A7898C0100 (4) Main 02-7947C0000
02-7861-9100 Axle 02-7861C0100 Axle
TOWING & TAXIING - ATA 9
01-1202-0000 01-0605-0000 (R)
ETT-8X
TTR-6
TTR-8
PARKING & MOORING - ATA 10
99-9028-6000
SERVICING - ATA 12
ENGINE OIL
06-5009C6800 06-5010-6800 06-5022-6800
ELECTRICAL POWER - ATA 24
11-2820-0000 112850 112860
HYDRAULIC POWER - ATA 29
5J21-DT (base model) 5J21-8 5J21-D Split System KHC-4000 KHC-4008 671A
LANDING GEAR - ATA 32
14-6801-0120 Z-1063-11 (R) Main Z-1063-08 (R) Nose
FUSELAGE - ATA 53
04-6029-5111 04-6029-5111-A5 04-6150-0120 K-2012 Gooseneck Boom Kit K-2013 Pneumatic Pump Kit K-2953 Hand Winch Kit
POWER PLANT - ATA 71
08T4049-0013

Leonardo (AgustaWestland)
AW169
LIFTING & SHORING - ATA 7
02-0517C0140 (4) Fwd/Aft 02-7918C9100 Axle
TOWING & TAXIING - ATA 9
ETT-8X
TTR-6
TTR-8
PARKING & MOORING - ATA 10
99-9028-6000 99-9045-9000
SERVICING - ATA 12
ENGINE OIL
06-5009C6800 06-5010-6800 06-5022-6800
HYDRAULIC FLUID
06-4005-0511 06-4035-0500 06-5022-6500 06-5042-0500 KHC-4001
NITROGEN
18-4201-1010 K-1225
18-4208-0010
18-4303-0000
18-4315-0000
18-4318-0000
PC-1107
K-3706
ELECTRICAL POWER - ATA 24
11-2820-0000 11-6610-6000 112850 112860
HYDRAULIC POWER - ATA 29
(base models) 5J21-GT 5J211GT_DEKQ48 50 hz countries 5J211GT_DFKQ48 60 hz countries 5J21-8 5J21-D Split System KHC-4000 KHC-4008 06-5051-6500 K-2339 (R)
ICE & RAIN PROTECTION - ATA 30
09-4003-4010
LANDING GEAR - ATA 32
14-4039-0010 14-6801-0120 TBD - Adapter Rings 14-6802-6000 14-6804-6000 14-6805-6010 14-6806-6011 14-6807-6011 14-6808-6000 14-6892-6000
FUSELAGE - ATA 53
04-6029-5111 04-6029-5111-A5 04-6150-0120 K-2012 Gooseneck Boom Kit K-2013 Pneumatic Pump Kit K-2953 Hand Winch Kit
POWER PLANT - ATA 71
08-4049-0013 08-4060-6700

Leonardo (AgustaWestland)
AW189
LIFTING & SHORING - ATA 7
02A7898C0100 (2) Fwd 02-0517C0140 (2) Aft 02-7918C9100 Axle
TOWING & TAXIING - ATA 9
ETT-8X
TTR-6
TTR-8
PARKING & MOORING - ATA 10
99-9028-6000 99-9045-9000
SERVICING - ATA 12
ENGINE OIL
06-5009C6800 06-5010-6800 06-5022-6800
HYDRAULIC FLUID
06-4005-0511 06-4035-0500 06-5022-6500 06-5042-0500 KHC-4001
NITROGEN
18-4201-1010 K-1225
18-4208-0010
18-4303-0000
18-4315-0000
18-4318-0000
PC-1107
K-3706
ELECTRICAL POWER - ATA 24
11-6610-6000 112850 112860
HYDRAULIC POWER - ATA 29
5J21-GT (base model) 5J21-8 5J21-D Split System KHC-4000 KHC-4008
ICE & RAIN PROTECTION - ATA 30
09-4003-4010
LANDING GEAR - ATA 32
14-4039-0010 14-6801-0120 Z-1063-11 (R) Main Z-1063-08 (R) Nose 14-6802-6000 14-6804-6000 14-6805-6010 14-6806-6011 14-6807-6011 14-6808-6000 14-6883-0110 14-6892-6000
FUSELAGE - ATA 53
04-6029-5111 04-6029-5111-A5 04-6150-0120 K-2012 Gooseneck Boom Kit K-2013 Pneumatic Pump Kit K-2953 Hand Winch Kit
POWER PLANT - ATA 71
08-4049-0013

Leonardo (AgustaWestland)
Mark II
LIFTING & SHORING - ATA 7
02A7898C0100 (2) Main R-1187-01 (R)
02A7898C0100 Nose R-1187-02 (R)
02-7947C0000
TOWING & TAXIING - ATA 9
01-1202-0000 01-0524-0000 (R)
01-1154-0000
01-1954-6000
01-1954-6002
ELECTRICAL POWER - ATA 24
11-2820-0000 112850 112860
HYDRAULIC POWER - ATA 29
5110-FR (base model) 5110-C Split System KHC-2257

Lockheed
A-10, T-33, F-15
AIR CONDITIONING - ATA 21
15-7609-6000-FJ K-4945 (R) K-4946 (R)

Lockheed
C-130
LIFTING & SHORING - ATA 7
50J25178-10E1 (2) Nose 972-018 (2) Nose 53J6268 (2) Wing 8654-010 (2) Wing 02-7830C0110 Axle
TOWING & TAXIING - ATA 9
01-1224-0010
PARKING & MOORING - ATA 10
99-9028-6000
SERVICING - ATA 12
HYDRAULIC FLUID
06-5022-6500-A7
HYDRAULIC FLUID
06-4035-0500 06-5021-1500 06-5042-0500
LAVATORY
10-4036-0001
NITROGEN
12-3103-6011
OXYGEN
20-4505-7000 20-4523-0000 PC-1124
ELECTRICAL POWER - ATA 24
11-4090-0000 11-4290-0000
FUEL - ATA 28
07-3000-1921-A3 07-3006-6900
HYDRAULIC POWER - ATA 29
5621-CH (base model) KHC-1022
LANDING GEAR - ATA 32
14-6802-6000 14-6805-6010 14-6806-6011 14-6807-6011 14-6833-6030 14-6886-0110 14-6892-6000 14-6895-6000
FUSELAGE - ATA 53
04-6029-5111 04-6029-5111-A5 04-6030-5111 04-6152-0120 K-2012 Gooseneck Boom Kit K-2013 Pneumatic Pump Kit K-2953 Hand Winch Kit
POWER PLANT - ATA 71
08-4049-0013

Lockheed
F-16
LIFTING & SHORING - ATA 7
50J25178 Tripod (3) CJ67D0250-1 Axle 7054-020
TOWING & TAXIING - ATA 9
01-1208-9011 01-1287-9000
SERVICING - ATA 12
PAO PF56103-10PWS
AIR CONDITIONING - ATA 21
15-7609-6000-FJ
LANDING GEAR - ATA 32
9092-012
FUSELAGE - ATA 53
9319-010

F-35 Joint Strike Fighter
LIFTING & SHORING - ATA 7
1041-1100 Nose 728D1100 Wing 1128AS100-5 Axle 1259-8000
SERVICING - ATA 12
ENGINE OIL
PF56103-1PWS
HYDRAULIC FLUID
06-5022-6500-A9
HYDRAULIC FLUID
PF56103-3P
LANDING GEAR - ATA 32
14-6907-9720

L-1011
TOWING & TAXIING - ATA 9
A212636D
ELECTRICAL POWER - ATA 24
11-4090-0000 11-4290-0000
HYDRAULIC POWER - ATA 29
5831-FJ (base model) 5831-C Dual System 5833 (base model) 60 hz countries KHC-1468
LANDING GEAR - ATA 32
17500M BC500P (R) 17500S-2 BC500P (R)

Lockheed
Jetstar C-140
LIFTING & SHORING - ATA 7
02-1036C0111 (2) Main 02-1036C0111 Nose 02-7813C0100 Axle 02-7947C0000
TOWING & TAXIING - ATA 9
01-1182-0010
PARKING & MOORING - ATA 10
99-9028-6000
SERVICING - ATA 12
ENGINE OIL
06-5009C6800 06-5010-6800 06-5022-6800 06-5042-0800
HYDRAULIC FLUID
06-4005-0511 06-4035-0500 06-5022-6500 06-5042-0500
NITROGEN
18-4201-1010 K-1225 18-4208-0010 18-4303-0000 18-4315-0000 18-4318-0000 PC-1107 K-3706
OXYGEN
20-4505-7000 20-4502-6000 20-4504-7000 20-4505-7000 20-4523-0000 20-4525-0000 PC-1006 PC-1124
ELECTRICAL POWER - ATA 24
11-2820-0000 11-6610-6000 112850 112860
FUEL - ATA 28
07-3000-1921-A3 07-3006-6900
HYDRAULIC POWER - ATA 29
5211-AB (base model) KHC-1005 KHC-4020
ICE & RAIN PROTECTION - ATA 30
09-4003-4010
LANDING GEAR - ATA 32
14-6801-0120 Z-1063-17 Main Z-1063-13 Nose
14-6802-6000 14-6804-6000 14-6805-6010 14-6806-6011 14-6807-6011 14-6808-6000 14-6883-0110 14-6892-6000
FUSELAGE - ATA 53
04-6028C0121 K-3057 Crane Hook Z-4082 Lift Tray 04-6029-5111 04-6029-5111-A5 04-6150-0120 K-2012 Gooseneck Boom Kit K-2013 Pneumatic Pump Kit K-2953 Hand Winch Kit
POWER PLANT - ATA 71
08-0102-4010 08-2021C0000 K-1795 (R) 08-2034-0010 K-2770 (R) 08-4049-0013

For detailed model information reference the items page(s) • Bracketed # = quantity • R = required

McDonnell Douglas
DC-8 Series 60
LIFTING & SHORING - ATA 7
71800B-2 Nose/Fwd 75900A-2 Wing/Main (2) 882100-6 Axle
PARKING & MOORING - ATA 10
99-9028-6000
SERVICING - ATA 12
ENGINE OIL
06-5022-6800 06-5024-3800 06-5042-0800
HYDRAULIC FLUID
06-4005-3611 06-4035-3600 06-5022-6600 06-5042-3600 06-5043-3600 KHC-2259
LAVATORY
10-6401-0010 K-2029 (R) K-2410 (R) 10-6403-6000 10-6411-0000 K-2029 (R) K-2410 (R)
POTABLE WATER
19-4301-0000 K-2411
NITROGEN
18-4201-1010 18-4208-0010 18-4303-0000 18-4315-0000 18-4318-0000 PC-1107 K-3706
OXYGEN
20-4500-7000 20-4502-6000 20-4504-7000 20-4505-7000 20-4523-0000 20-4525-0000 PC-1006 PC-1009 PC-1124
ELECTRICAL POWER - ATA 24
11-6610-6000
FUEL - ATA 28
07-3000-1921
HYDRAULIC POWER - ATA 29
5631-BC (base model) KHC-1160 KHC-4029
LANDING GEAR - ATA 32
14-6883-0110 K-2965 (R) 14-6802-6000 14-6804-6000 14-6805-6010 14-6806-6011 14-6808-6000 14-6830-6012 14-6878-0110 14-6892-6000 17500M BC500P (R) 17500S-2 BC500P (R)
FUSELAGE - ATA 53
04-6001-1100 04-6030-5111
POWER PLANT - ATA 71
08-4048-0013

McDonnell Douglas
DC-9 Series 10, 20, 30, 33
LIFTING & SHORING - ATA 7
02-1032C0111 Fwd 02-1256C0111 Aft (w/out stairs) 02-1040C0111 Aft - 10, 20, 30 only 02-7844C0111 Aft - 33 only 02-7947C0000
TOWING & TAXIING - ATA 9
ETT-8X ETT-12X TTR-6 TTR-12
PARKING & MOORING - ATA 10
99-9028-6000
SERVICING - ATA 12
ENGINE OIL
06-5022-6800 06-5024-3800 06-5042-0800
HYDRAULIC FLUID
06-4005-3611 06-4035-3600 06-5022-6600 06-5042-3600 06-5043-3600 KHC-1009
LAVATORY
10-6401-0010 K-2029 (R) K-2410 (R) 10-6403-6000 10-6411-0000 K-2029 (R) K-2410 (R)
POTABLE WATER
19-4301-0000 K-2411
NITROGEN
18-4201-1010 18-4208-0010 18-4303-0000 18-4315-0000 18-4318-0000 PC-1107 K-3706
OXYGEN
20-4500-7000 20-4502-6000 20-4504-7000 20-4505-7000 20-4523-0000 20-4525-0000 PC-1006 PC-1009 PC-1124
ELECTRICAL POWER - ATA 24
11-6610-6000
FUEL - ATA 28
07-3000-1921
HYDRAULIC POWER - ATA 29
5431-BC (base model) KHC-1160 KHC-4029
LANDING GEAR - ATA 32
14-6883-0110 K-2965 (R) 14-6802-6000 14-6804-6000 14-6805-6010 14-6806-6011 14-6808-6000 14-6830-6012 14-6878-0110 14-6892-6000 17500M BC500P (R) 17500S-2 BC500P (R)
FUSELAGE - ATA 53
04-6001-1100 04-6030-5111

McDonnell Douglas
DC-9 Series 40, 50
LIFTING & SHORING - ATA 7
02A7850C0100 (2) Main 02A1032C0111 Fwd 02A7844C0111 Aft 02-7947C0000
TOWING & TAXIING - ATA 9
A005269D A005384D ETT-8X ETT-12X TTR-8 TTR-12
PARKING & MOORING - ATA 10
99-9028-6000
SERVICING - ATA 12
ENGINE OIL
06-5022-6800 06-5042-0800 06-5043-1800
HYDRAULIC FLUID
06-4005-3611 06-4035-3600 06-5022-6600 06-5042-3600 06-5043-3600 KHC-1009
LAVATORY
10-6401-0010 K-2029 (R) K-2410 (R) 10-6403-6000 10-6411-0000 K-2029 (R) K-2410 (R)
POTABLE WATER
19-4301-0000 K-2411
NITROGEN
18-4201-1010 18-4208-0010 18-4303-0000 18-4315-0000 18-4318-0000 PC-1107 K-3706
OXYGEN
20-4500-7000 20-4503-6000 20-4504-7000 20-4505-7000 20-4523-0000 20-4525-0000 PC-1006 PC-1009 PC-1124
ELECTRICAL POWER - ATA 24
11-6610-6000
FUEL - ATA 28
07-3000-1921
HYDRAULIC POWER - ATA 29
5431-BC (base model) KHC-1160 KHC-4029
LANDING GEAR - ATA 32
14-6883-0110 K-2965 (R) 14-6802-6000 14-6804-6000 14-6805-6010 14-6806-6011 14-6808-6000 14-6830-6012 14-6878-0110 14-6892-6000 17500M BC500P (R) 17500S-2 BC500P (R)
FUSELAGE - ATA 53
04-6001-1100 04-6030-5111

McDonnell Douglas
DC-10
LIFTING & SHORING - ATA 7
874600-8 NLG & MLG 73300A-10 Nose/Fwd 88100B-7 (2) Wing/Main
TOWING & TAXIING - ATA 9
A003806D A212636D
PARKING & MOORING - ATA 10
99-9028-6000
SERVICING - ATA 12
ENGINE OIL
06-5010-6800 06-5022-6800 06-5024-3800 06-5042-0800
HYDRAULIC FLUID
06-4005-3611 06-4035-3600 06-5022-6600 06-5042-3600 06-5043-3600
LAVATORY
10-6401-0010 K-2029 (R) K-2410 (R) 10-6403-6000 10-6411-0000 K-2029 (R) K-2410 (R)
POTABLE WATER
19-4301-0000 K-2411
NITROGEN
18-4201-1010 18-4208-0010 18-4303-0000 18-4315-0000 18-4318-0000 PC-1107 K-3706
OXYGEN
20-4500-7000 20-4502-6000 20-4504-7000 20-4505-7000 20-4523-0000 20-4525-0000 PC-1006 PC-1009 PC-1124
ELECTRICAL POWER - ATA 24
11-4090-0000 11-4290-0000 11-6610-6000
FUEL - ATA 28
07-3000-1921
HYDRAULIC POWER - ATA 29
5833 (base model) KHC-1468
LANDING GEAR - ATA 32
14-6802-6000 14-6804-6000 14-6805-6010 14-6806-6011 14-6808-6000 14-6830-6012 14-6878-0110 14-6883-0110 14-6892-6000 17500M BC500P (R) 17500S-2 BC500P (R)
FUSELAGE - ATA 53
04-6001-1100 04-6030-5111

McDonnell Douglas
MD-11
LIFTING & SHORING - ATA 7
874600-8 NLG & MLG 848700A-2 (2) Wing/Tip 88100B-7 (2) Wing/Main 73300A-10 Tail/Aft
TOWING & TAXIING - ATA 9
A212636D
PARKING & MOORING - ATA 10
99-9028-6000
SERVICING - ATA 12
ENGINE OIL
06-5010-6800 06-5022-6800 06-5024-3800 06-5042-0800
HYDRAULIC FLUID
06-4005-3611 06-4035-3600 06-5022-6600 06-5042-3600 06-5043-3600
LAVATORY
10-6401-0010 K-2029 (R) K-2410 (R) 10-6403-6000 10-6411-0000 K-2029 (R) K-2410 (R)
POTABLE WATER
19-4301-0000 K-2411
NITROGEN
18-4201-1010 18-4208-0010 18-4303-0000 18-4315-0000 18-4318-0000 PC-1107 K-3706
OXYGEN
20-4500-7000 20-4502-6000 20-4504-7000 20-4505-7000 20-4523-0000 20-4525-0000 PC-1006 PC-1009 PC-1124
ELECTRICAL POWER - ATA 24
11-4090-0000 11-4290-0000 11-6610-6000
FUEL - ATA 28
07-3000-1921
HYDRAULIC POWER - ATA 29
5833-BJ (base model) KHC-1468
LANDING GEAR - ATA 32
14-6802-6000 14-6804-6000 14-6805-6010 14-6806-6011 14-6808-6000 14-6830-6012 14-6878-0110 14-6883-0110 14-6892-6000 17500M BC500P (R) 17500S-2 BC500P (R)
FUSELAGE - ATA 53
04-6001-1100 04-6030-5111

McDonnell Douglas
MD-80
LIFTING & SHORING - ATA 7
Recommended: 64200S NLG Recommended: 882100-6 MLG Recommended: 75900A-2 (2) Wing/Main Recommended: 71800B-2 Tail/Aft 02A7850C0100 (2) Main 02A1032C0111 Fwd 02A7844C0111 Aft 02-7947C0000
TOWING & TAXIING - ATA 9
A005269D A005384D ETT-8X ETT-12X TTR-12 TTR-12
PARKING & MOORING - ATA 10
99-9028-6000
SERVICING - ATA 12
ENGINE OIL
06-5010-6800 06-5022-6800 06-5042-0800
HYDRAULIC FLUID
06-4005-3611 06-4035-3600 06-5022-6600 06-5042-3600 06-5043-3600 KHC-1009
LAVATORY
10-6401-0010 K-2029 (R) K-2410 (R) 10-6403-6000 10-6411-0000 K-2029 (R) K-2410 (R)
POTABLE WATER
19-4301-0000 K-2411
NITROGEN
18-4201-1010 18-4208-0010 18-4303-0000 18-4315-0000 18-4318-0000 PC-1107 K-3706
OXYGEN
20-4500-7000 20-4502-6000 20-4504-7000 20-4505-7000 20-4523-0000 20-4525-0000 PC-1006 PC-1009 PC-1124
ELECTRICAL POWER - ATA 24
11-4090-0000 11-4290-0000 11-6610-6000
FUEL - ATA 28
07-3000-1921
HYDRAULIC POWER - ATA 29
5431-BC (base model) KHC-1160 KHC-4029
LANDING GEAR - ATA 32
14-6802-6000 14-6804-6000 14-6805-6010 14-6806-6011 14-6808-6000 14-6830-6012 14-6878-0110 14-6883-0110 14-6892-6000 17500M BC500P (R) 17500S-2 BC500P (R)
FUSELAGE - ATA 53
04-6001-1100 04-6030-5111

McDonnell Douglas
MD-88, MD90
TOWING & TAXIING - ATA 9
A005269D A005384D

For detailed model information reference the items page(s) • Bracketed # = quantity • R = required

Mitsubishi
MU-2 Marquise, Mu-2 Solitaire
LIFTING & SHORING - ATA 7
02-0566C0110 Main (2) 02-0222C0111 Nose 02-7947C0000
TOWING & TAXIING - ATA 9
01-1202-0000 01-0508-0000 (R) 01-1954-6000 01-1954-6002 eJP-3 eJP-3J ETT-8X TTR-6 TTR-8
AIR CONDITIONING - ATA 21
15-7605-6010 K-1660 (R)
ELECTRICAL POWER - ATA 24
11-2820-0000

Mooney
All
LIFTING & SHORING - ATA 7
02-0222C0111 Main (2) 02-7947C0000
TOWING & TAXIING - ATA 9
01-1112-0010 eJP-3 eJP-3L
ELECTRICAL POWER - ATA 24
11-2820-0000

Nihon
YS-11
LIFTING & SHORING - ATA 7
02-1256C0111 Main (2) 02-1256C0111 Nose 02-7947C0000
TOWING & TAXIING - ATA 9
01-1201-0010 01-0548-0000 (R) 01-1954-6000 01-1954-6002 ETT-8X ETT-12X TTR-6 TTR-8
ELECTRICAL POWER - ATA 24
11-2820-0000
HYDRAULIC POWER - ATA 29
5211-AA (base model) KHC-1004 KHC-4020

Nomad
Nomad
LIFTING & SHORING - ATA 7
02-0522C0141 Main (2) 02-7947C0000
TOWING & TAXIING - ATA 9
01-1201-0010 01-0529-0000 (R) 01-1954-6000 01-1954-6002
ELECTRICAL POWER - ATA 24
11-2820-0000

Northrop
E2C Hawkeye
SERVICING - ATA 12
ENGINE OIL
KHC-2046

Firebird
LIFTING & SHORING - ATA 7
02-7947C0000
TOWING & TAXIING - ATA 9
01-2008-0000

T-38
TOWING & TAXIING - ATA 9
01-1202-0000 01-0539-0000 (R) 01-1954-6000 01-1954-6002 eJP-3 eJP-3L
AIR CONDITIONING - ATA 21
15-7609-6000-FJ K-4943 (R) K-4946 (R)
ELECTRICAL POWER - ATA 24
11-2820-0000
HYDRAULIC POWER - ATA 29
5411 (base model) 671A KHC-1005

Piaggio
P-180 Avanti
LIFTING & SHORING - ATA 7
02-7812C0110 Main (2) 02-0517C0140 Nose 02-7863C0100 Axle 03-0513-0000 Tail Stand 02-7947C0000
TOWING & TAXIING - ATA 9
01-1202-0000 01-0570-0010 (R) 01-1222-0000 01-1227-0000 01-2006-0000 01-1954-6000 01-1954-6002 eJP-3 eJP-3L TTR-6
PARKING & MOORING - ATA 10
99-9016-6000-A1
SERVICING - ATA 12
ENGINE OIL
06-5009C6800 06-5010-6800 06-5022-6800 06-5042-0800
HYDRAULIC FLUID
06-4005-0511 06-4035-0500 06-5022-6500 06-5042-0500
NITROGEN
12-3100-1000 18-4200-1100 18-4208-0010 18-4303-0000 18-4315-0000 18-4318-0000 PC-1107 K-3706
OXYGEN
12-3100-1000 20-4500-7000 20-4502-6000 20-4504-7000 20-4505-7000 20-4523-0000 20-4525-0000 PC-1006 PC-1124 K-3337
ELECTRICAL POWER - ATA 24
11-2820-0000 11-6610-6000 112850 112860
FUEL - ATA 28
07-3000-1921
ICE & RAIN - ATA 30
09-6200-0010
LANDING GEAR - ATA 32
14-6801-0120 Z-1063-12 (R) Z-1064-11 (R) 14-6802-6000 14-6804-6000 14-6805-6010 14-6806-6011 14-6807-6011 14-6808-6000 14-6830-6012 14-6883-0110 14-6892-6000
FUSELAGE - ATA 53
04-6014-0010 04-6028C0121 K-3057 Crane Hook (R) K-4082 Lift Tray (R) 04-6029-5111 04-6029-5111-A5 04-6150-0120 K-2012 Gooseneck Boom Kit K-2013 Pneumatic Pump Kit K-2953 Hand Winch Kit 04-6152-0120 K-2012 Gooseneck Boom Kit K-2013 Pneumatic Pump Kit K-2953 Hand Winch Kit
POWER PLANT - ATA 71
08T4049-0013

Pilatus
PC-9
LIFTING & SHORING - ATA 7
02-7838C0110 Main (2) 02-7838C0110 Nose 02-7852C0100 Axle 02-7947C0000 03-4006-0000 Stabilizing Stand
TOWING & TAXIING - ATA 9
01-1202-0000 01-0595-0000 (R) 01-1273-0010 01-1954-6000 01-1954-6002 eJP-3 eJP-3L TTR-6
PARKING & MOORING - ATA 10
99-9008-6000
SERVICING - ATA 12
ENGINE OIL
06-5009C6800 06-5010-6800 06-5022-6800
HYDRAULIC FLUID
06-4005-0511 06-5022-6500 06-5042-0500
NITROGEN
12-3104-0000 18-4200-1100 18-4208-0010 18-4303-0000 18-4315-0000 18-4318-0000 PC-1107 K-3706
OXYGEN
12-3104-0000 20-4502-6000 20-4504-7000 20-4505-7000 20-4523-0000 20-4525-0000 PC-1009 PC-1124
ELECTRICAL POWER - ATA 24
11-2820-0000 11-6610-6000 112850 112860
FUEL - ATA 28
07-3000-1921 07-3006-6900
HYDRAULIC POWER - ATA 29
51100AB1 51100AB3
ICE & RAIN - ATA 30
09-4003-4010
LANDING GEAR - ATA 32
14-6801-0120 Z-1063-15 Main (R) Z-1063-11 Nose (R)
14-6802-6000 14-6804-6000 14-6806-6011 14-6807-6011 14-6808-6000 14-6883-0110 14-6892-6000
FUSELAGE - ATA 53
04-6027-0110 04-6029-5111 04-6029-5111-A5 04-6150-0120 K-2012 Gooseneck Boom Kit K-2013 Pneumatic Pump Kit K-2953 Hand Winch Kit
POWER PLANT - ATA 71
08-4053-0013 08-4054-0010

Pilatus
PC-12
LIFTING & SHORING - ATA 7
02-0526C0110 Main (2) K-3582 (R) 02-0544C0110 Tail K-3582 (R) 02-7853C0100 Axle 02-7933C0100 Axle Alternative 02-7947C0000
TOWING & TAXIING - ATA 9
01-1202-0000 01-0625-0000 (R) 01-1254-0000 01-1950-5000 01-1954-6000 01-1954-6002 eJP-3 K-4054 (R) eJP-3L TTR-6
PARKING & MOORING - ATA 10
99-9028-6000
SERVICING - ATA 12
ENGINE OIL
06-5009C6800 06-5010-6800 06-5022-6800
HYDRAULIC FLUID
06-4005-3611 06-4035-3600 06-5022-6600 06-5042-3600
NITROGEN
18-4201-1010 18-4208-0010 18-4303-0000 18-4315-0000 18-4318-0000 PC-1107 K-3706
OXYGEN
20-4500-7000 20-4502-6000 20-4505-7000 20-4523-0000 PC-1009 PC-1124
AIR CONDITIONING - ATA 21
15_7603-1000 (base model) K-2453 (R) 15-7605-6010 K-2453 (R)
ELECTRICAL POWER - ATA 24
11-2820-0000 11-6610-6000 112850 112860
FUEL - ATA 28
07-3000-1921 07-3006-6900
HYDRAULIC POWER - ATA 29
5110-AB (base model) KHC-1005 KHC-4020
ICE & RAIN - ATA 30
09-6200-0010
LANDING GEAR - ATA 32
14-6801-0120 Z-1063-13 Main (R) Z-1063-09 Nose (R)
14-6802-6000 14-6804-6000 14-6805-6010 14-6806-6011 14-6807-6011 14-6808-6000 14-6833-6030 14-6883-0110 14-6892-6000
FUSELAGE - ATA 53
04-6028C0121 K-3057 Crane Hook (R) Z-4082 Lift Tray (R) 04-6046-0100 04-6150-0120 K-2012 Gooseneck Boom Kit K-2013 Pneumatic Pump Kit K-2953 Hand Winch Kit
POWER PLANT - ATA 71
08-4048-0013

Pilatus
PC-24
LIFTING & SHORING - ATA 7
02-0527C0140 Main (2) 02-0527C0140 Nose 02-7837C0110 Tail 02-7933C0100 Axle 03A8561C0000 Stabilizing Stand
TOWING & TAXIING - ATA 9
01-1202-0000 01-0625-0000 (R) 01-1950-5000 01-1954-6000 01-1954-6002 eJP-3 K-4054 (R) eJP-3L TTR-6
PARKING & MOORING - ATA 10
99-9028-6000
SERVICING - ATA 12
ENGINE OIL
06-5009C6800 06-5010-6800 06-5022-6800 06-5042-0800 06-5043-1800
HYDRAULIC FLUID
06-4005-0800 06-4035-0800 06-5009C6800 06-5010-6800 06-5022-6800 06-5042-0800
LAVATORY
10-4036-0010 10-6403-6000 10-6408-0000 K-2410 (R) K-2412 (R) 10-6409-0000
NITROGEN
18-4201-1010 18-4208-0010 18-4303-0000 PC-1107 K-3706
OXYGEN
20-4500-7000 20-4502-6000 20-4505-7000 PC-1009 PC-1124
AIR CONDITIONING - ATA 21
15_7603-1000 (base model) K-5124 (R)
ELECTRICAL POWER - ATA 24
11-2820-0000 11-6610-6000 112850 112860
FUEL - ATA 28
07-3000-1921 07-3006-6900
ICE & RAIN - ATA 30
09-6200-0010
LANDING GEAR - ATA 32
14-6801-0120 Z-1063-13 Main (R) Z-1063-08 Nose (R)
14-6802-6000 14-6804-6000 14-6805-6010 14-6806-6011 14-6807-6011 14-6808-6000 14-6833-6030 14-6883-0110 14-6909C0000
FUSELAGE - ATA 53
04-6028C0121 K-3057 Crane Hook (R) Z-4082 Lift Tray (R) 04-6150-0120 K-2012 Gooseneck Boom Kit K-2013 Pneumatic Pump Kit K-2953 Hand Winch Kit
POWER PLANT - ATA 71
08-0147C4000 08-4049-0013 08-2021C0000 K-4190 (R)

For detailed model information reference the items page(s) • Bracketed # = quantity • R = required

Piper
Aerostar, Chieftan, Navajo
LIFTING & SHORING - ATA 7
02-0234-0111 Main (2) 02-7947C0000 03-4006-0000 Stabilizing Stand
TOWING & TAXIING - ATA 9
01-1202-0000 01-0511-0010 (R) 01-1112-0010 01-1954-6000 01-1954-6002 eJP-3 eJP-3L TTR-6
AIR CONDITIONING - ATA 21
15_7603-1000 (base model) K-1381 (R) 15-7605-6010 K-1381 (R)
ELECTRICAL POWER - ATA 24
11-2820-0000
HYDRAULIC POWER - ATA 29
5010-AR (base model) 50111ZZG KHC-1038

Piper
Cheyenne II, III
LIFTING & SHORING - ATA 7
02-0536C0110 Main (2) 02-0536C0110 Nose 02-7947C0000 03-4006-0000 Stabilizing Stand
TOWING & TAXIING - ATA 9
01-1202-0000 01-0511-0010 (R) 01-1112-0010 01-1954-6000 01-1954-6002 eJP-3 eJP-3L TTR-6
AIR CONDITIONING - ATA 21
15_7603-1000 (base model) K-1381 (R) 15-7605-6010 K-1381 (R)
ELECTRICAL POWER - ATA 24
11-2820-0000
HYDRAULIC POWER - ATA 29
5010-AR (base model) 50111ZZG KHC-1038

PZL Mielec
M28
LIFTING & SHORING - ATA 7
02-0520C0111 Main (2) 02-0520C0111 Nose
TOWING & TAXIING - ATA 9
TTR-6

Aztec, Comanche, Seneca
LIFTING & SHORING - ATA 7
02-0222C0111 Main (2) 02-7947C0000 03-4006-0000 Stabilizing Stand
TOWING & TAXIING - ATA 9
01-1233-0010 eJP-3 eJP-3L TTR-6
ELECTRICAL POWER - ATA 24
11-2820-0000
HYDRAULIC POWER - ATA 29
5010-AR (base model) 50111ZZG KHC-1038

Cherokee
LIFTING & SHORING - ATA 7
02-0222C0111 Main (2) 02-7947C0000 03-4006-0000 Stabilizing Stand
TOWING & TAXIING - ATA 9
01-1233-0010 eJP-3 eJP-3L TTR-6

Saab	
340	
LIFTING & SHORING - ATA 7	LANDING GEAR - ATA 32
02-1248C0112 Main (2) 02-0540C0110 Nose 02-7813C0110 Axle 02-7947C0000 03-5805-0000 Tail Stand	14-6801-0120 Z-1063-13 Main (R) Z-1064-09 Nose (R) 14-6802-6000 14-6804-6000
TOWING & TAXIING - ATA 9	14-6805-6010 14-6806-6011 14-6807-6011 14-6808-6000 14-6883-0110 14-6892-6000
01-1201-0000 01-0545-0011 (R) 01-1187-0011 01-1290-0100 01-0545-0011 (R) 01-1954-6000 01-1954-6002	FUSELAGE - ATA 53
eJP-3 eJP-3L TTR-6	04-6001-1100 04-6028C0121 K-3057 Crane Hook (R) Z-4082 Lift Tray (R)
PARKING & MOORING - ATA 10	04-6029-5111 04-6029-5111-A5 04-6150-0120 K-2012 Gooseneck Boom Kit K-2013 Pneumatic Pump Kit K-2953 Hand Winch Kit
99-9010-6000	POWER PLANT - ATA 71
SERVICING - ATA 12	08-0106-4000 08-0108-4000 08-0134-4000 K-2909 (R) 08-4048-0013 K-1357 (R)
ENGINE OIL	
06-5009C6800 06-5010-6800 06-5022-6800 06-5042-0800	
HYDRAULIC FLUID	
06-4005-0511 06-4035-0500 06-5022-6500 06-5042-0500	
LAVATORY	
10-4036-0010 K-2029 (R) K-2410 (R) 10-6403-6000 10-6408-0000 K-2029 (R) K-2410 (R) 10-6409-0000	
POTABLE WATER	
19-4305-0000 19-4306-0000 K-2411	
NITROGEN	
18-4201-1010 18-4208-0010 18-4303-0000 18-4315-0000 18-4318-0000 PC-1107 K-3706	
OXYGEN	
20-4504-7000 20-4505-7000 20-4523-0000 20-4525-0000 PC-1006 PC-1124	
AIR CONDITIONING - ATA 21	
15_7603-1000 (base model)	
ELECTRICAL POWER - ATA 24	
11-2820-0000 112850 112860	
FUEL - ATA 28	
07-3000-1921 07-3006-6900	
ICE & RAIN - ATA 30	
09-6200-0010	

Saab	
2000	
LIFTING & SHORING - ATA 7	LANDING GEAR - ATA 32
02-1248C0112 Main (2) 02-0540C0110 Nose 02-7813C0110 Axle 02-7947C0000	14-6801-0120 Z-1063-19 Main (R) Z-1064-11 Nose (R) 14-6802-6000 14-6804-6000
TOWING & TAXIING - ATA 9	14-6805-6010 14-6806-6011 14-6807-6011 14-6808-6000 14-6883-0110 14-6892-6000
01-1201-0000 01-0545-0011 (R) 01-1290-0100 01-0545-0011 (R) 01-1954-6000 01-1954-6002	FUSELAGE - ATA 53
ETT-8X ETT-12X TTR-6 TTR-8	04-6001-1100 04-6028C0121 K-3057 Crane Hook (R) Z-4082 Lift Tray (R)
PARKING & MOORING - ATA 10	04-6029-5111 04-6029-5111-A5 04-6150-0120 K-2012 Gooseneck Boom Kit K-2013 Pneumatic Pump Kit K-2953 Hand Winch Kit
99-9010-6000	POWER PLANT - ATA 71
SERVICING - ATA 12	08-0106-4000 08-0108-4000 08-0134-4000 K-2909 (R) 08-4048-0013 K-1357 (R)
ENGINE OIL	
06-5009C6800 06-5010-6800 06-5022-6800 06-5042-0800	
HYDRAULIC FLUID	
06-4005-0511 06-4035-0500 06-5022-6500 06-5042-0500	
LAVATORY	
10-4036-0010 K-2029 (R) K-2410 (R) 10-6403-6000 10-6408-0000 K-2029 (R) K-2410 (R) 10-6409-0000	
POTABLE WATER	
19-4305-0000 19-4306-0000 K-2411	
NITROGEN	
18-4201-1010 18-4208-0010 18-4303-0000 18-4315-0000 18-4318-0000 PC-1107 K-3706	
OXYGEN	
20-4500-7000 20-4502-6000 20-4504-7000 20-4505-7000 20-4523-0000 20-4525-0000 PC-1124 K-2717	
AIR CONDITIONING - ATA 21	
15_7603-1000 (base model)	
ELECTRICAL POWER - ATA 24	
11-4090-0000 11-4290-0000 11-6610-6000 112850 112860	
FUEL - ATA 28	
07-3000-1921 07-3006-6900	
HYDRAULIC POWER - ATA 29	
5411-GP (base model) 5411-C Split System KHC-2280	
ICE & RAIN - ATA 30	
09-6200-0010	

For detailed model information reference the items page(s) • Bracketed # = quantity • R = required

Sabreliner	
40, 60, 70 Series	
LIFTING & SHORING - ATA 7	FUSELAGE - ATA 53
02-7856C0100 Main (2) 02-7856C0100 Tail 02-7813C0110 Axle 02-7947C0000	04-6028C0121 K-3057 Crane Hook (R) Z-4082 Lift Tray (R) 04-6029-5111 04-6029-5111-A5 04-6152-0120 K-2012 Gooseneck Boom Kit K-2013 Pneumatic Pump Kit K-2953 Hand Winch Kit
TOWING & TAXIING - ATA 9	POWER PLANT - ATA 71
01-1202-0000 01-0503-0000 (R) 01-1950-5000 01-1954-6000 01-1954-6002 eJP-3 K-4177 eJP-3L K-4177	08-0100-4000 08-0102-4010 08-2001-0000 K-2112 (R) K-2113 (R) 08-2021C0000 K-1795 08-2030-0000 K-2770 08-4048-0013
PARKING & MOORING - ATA 10	
99-9028-6000	
SERVICING - ATA 12	
ENGINE OIL	
06-5009C6800 06-5010-6800 06-5022-6800 06-5042-0800	
HYDRAULIC FLUID	
06-4005-0511 06-4035-0500 06-5022-6500 06-5042-0500	
NITROGEN	
18-4200-1100 18-4208-0010 18-4303-0000 18-4315-0000 18-4318-0000 PC-1107 K-3706	
OXYGEN	
20-4500-7000 20-4502-6000 20-4504-7000 20-4505-7000 20-4523-0000 20-4525-0000 PC-1124 K-2717	
AIR CONDITIONING - ATA 21	
15_7603-1000 (base model)	
ELECTRICAL POWER - ATA 24	
11-2820-0000 11-6610-6000 112850 112860	
FUEL - ATA 28	
07-3000-1921 07-3006-6900	
HYDRAULIC POWER - ATA 29	
5110-AB (base model) KHC-1005 KHC-4020	
ICE & RAIN - ATA 30	
09-6200-0010	
LANDING GEAR - ATA 32	
14-6801-0120 Z-1063-15 Main (R) Z-1063-17 Main (R) Z-1064-13 Nose (R) 14-6802-6000 14-6804-6000 14-6805-6010 14-6806-6011 14-6807-6011 14-6808-6000 14-6883-0110 14-6892-6000	

Shorts	
330, 360	
LIFTING & SHORING - ATA 7	FUSELAGE - ATA 53
02-7809C0110 Main (2) 02-0526C0110 Nose 02-7813C0110 Axle 02-7947C0000	04-6028C0121 K-3057 Crane Hook (R) Z-4082 Lift Tray (R) 04-6150-0120 K-2012 Gooseneck Boom Kit K-2013 Pneumatic Pump Kit K-2953 Hand Winch Kit
TOWING & TAXIING - ATA 9	POWER PLANT - ATA 71
01-1201-0000 01-0518-0010 (R) 01-0551-0010 (R) 01-1188-0010 01-1950-5000 01-1954-6000 01-1954-6002 eJP-3 eJP-3L TTR-6	08T4049-0013 K-1152 (R)
PARKING & MOORING - ATA 10	
99-9010-6000	
SERVICING - ATA 12	
ENGINE OIL	
06-5009C6800 06-5010-6800 06-5022-6800 06-5042-0800	
HYDRAULIC FLUID	
06-4005-0511 06-4035-0500 06-5022-6500 06-5042-0500	
LAVATORY	
10D4036-0010 K-1036	
POTABLE WATER	
19-4305-0000 19-4306-0000 K-2411	
NITROGEN	
18-4200-1100 18-4208-0010 18-4303-0000 18-4315-0000 18-4318-0000 PC-1107 K-3706	
OXYGEN	
20-4500-7000 20-4502-6000 20-4504-7000 20-4505-7000 20-4523-0000 20-4525-0000 PC-1124	
AIR CONDITIONING - ATA 21	
15_7603-1000 (base model)	
ELECTRICAL POWER - ATA 24	
11-6610-6000 112850 112860	
FUEL - ATA 28	
07-3000-1921 07-3006-6900	
HYDRAULIC POWER - ATA 29	
5110-ZZ (base model)	
ICE & RAIN - ATA 30	
09-6200-0010	
LANDING GEAR - ATA 32	
14-6801-0120 Z-3072-20 Main (R) Z-1063-09 Nose (R) 14-6802-6000 14-6804-6000 14-6805-6010 14-6806-6011 14-6807-6011 14-6808-6000 14-6883-0110 14-6892-6000	

Sikorsky
CH-148
LIFTING & SHORING - ATA 7
02-0517C0140 Fwd (2) 02-0517C0140 Aft 02-7813C0100 Axle 02-7947C0000
TOWING & TAXIING - ATA 9
01-1202-0000 01-0599-0010 (R) 01-1244-0000 01-1325-0100 01-1954-6000 01-1954-6002 TTR-6
SERVICING - ATA 12
ENGINE OIL
06-5009C6800 06-5010-6800 06-5022-6800
HYDRAULIC FLUID
06-4005-0511 06-4035-0500 06-5022-6500 06-5042-0500
NITROGEN
12-3104-0000 18-4201-1010 18-4208-0010 18-4303-0000 18-4315-0000 18-4318-0000 PC-1107 K-3706
SHIMMY DAMPER
06-5056-1D00
ELECTRICAL POWER - ATA 24
11-2820-0000 11-6602-1000 11-6610-6000 112850 112860 92-0552-9010
FUEL - ATA 28
07-3000-1921 07-3006-6900
HYDRAULIC POWER - ATA 29
5J41-CS (base model) KHC-3827 KHC-4033
ICE & RAIN - ATA 30
09-4003-4010
LANDING GEAR - ATA 32
14-6801-0120 Z-1063-09 (R) 14-6802-6000 14-6804-6000 14-6805-6010 14-6806-6011 14-6807-6011 14-6808-6000 14-6892-6000
FUSELAGE - ATA 53
04-6029-5111 04-6029-5111-A5 04-6150-0120 K-2012 Gooseneck Boom Kit K-2013 Pneumatic Pump Kit K-2953 Hand Winch Kit
POWER PLANT - ATA 71
08-4049-0013 K-3979 (R)

Sikorsky
H-92 Superhawk
LIFTING & SHORING - ATA 7
02-0517C0140 Fwd (2) 02-0517C0140 Aft 02-7813C0100 Axle 02-7947C0000
TOWING & TAXIING - ATA 9
01-1202-0000 01-0599-0010 (R) 01-1325-0100 01-1954-6000 01-1954-6002 TTR-6
SERVICING - ATA 12
ENGINE OIL
06-5009C6800 06-5010-6800 06-5022-6800
HELIUM
18-4306-0000
HYDRAULIC FLUID
06-4005-0511 06-4035-0500 06-5022-6500 06-5042-0500
NITROGEN
12-3104-0000 18-4201-1010 18-4208-0010 18-4303-0000 18-4315-0000 18-4318-0000 PC-1107 K-3706
SHIMMY DAMPER
06-5056-1D00
ELECTRICAL POWER - ATA 24
11-2820-0000 11-6602-1000 11-6610-6000 112850 112860 92-0552-9010
FUEL - ATA 28
07-3000-1921 07-3006-6900
HYDRAULIC POWER - ATA 29
5J41-CS (base model) KHC-3827 KHC-4033
ICE & RAIN - ATA 30
09-4003-4010
LANDING GEAR - ATA 32
14-6801-0120 Z-1063-11 (R) 14-6802-6000 14-6804-6000 14-6805-6010 14-6806-6011 14-6807-6011 14-6808-6000 14-6892-6000
FUSELAGE - ATA 53
04-6029-5111 04-6029-5111-A5 04-6150-0120 K-2012 Gooseneck Boom Kit K-2013 Pneumatic Pump Kit K-2953 Hand Winch Kit
POWER PLANT - ATA 71
08-4049-0013 K-3979 (R)

Sikorsky
MH-60R, MH-60S Seahawk, HH-60H/J, SH-60B/F, S-70B, S-70C-6, S-70i, UH-60/UH-60M Black Hawk
LIFTING & SHORING - ATA 7
02-7809C0110 Main (2) 02A7849C0120 Tail R-1961 (R) 02-7947C0000
TOWING & TAXIING - ATA 9
TTR-6 - All
HH-60H/J, MH-60R, SH-60B/F, S-70B, S-70i: 01-1221-0006 01-1242-0000
MH-60S Seahawk, UH-60 Black Hawk: 01-1185-0006 01-1185-0011
PARKING & MOORING - ATA 10
99-9028-6000
SERVICING - ATA 12
ENGINE OIL
06-5009C6800 06-5010-6800 06-5022-6800 06-5042-0800
HYDRAULIC FLUID
06-5022-6500-A7 Military RSU N-2417-06 (R) N-2705-06 (R)
HYDRAULIC FLUID
06-4005-0511 06-4035-0500 06-5022-6500 06-5042-0500
NITROGEN
18-4201-1010 18-4208-0010 18-4303-0000 18-4315-0000 18-4318-0000 PC-1107 K-3706
ELECTRICAL POWER - ATA 24
11-4090-0000 11-4290-0000 11-6610-6000
FUEL - ATA 28
07-3000-1921 07-3006-6900
HYDRAULIC POWER - ATA 29
5221-EA (base model) 5221-C Split System KHC-1004 KHC-4020
ICE & RAIN - ATA 30
09-4003-4010
LANDING GEAR - ATA 32
14-6801-0120 Z-1063-14 Main (R) Z-1063-08 Tail (R) 14-6802-6000 14-6804-6000 14-6805-6010 14-6806-6011 14-6807-6011 14-6808-6000 14-6883-0110 14-6892-6000
FUSELAGE - ATA 53
04-6029-5111 04-6029-5111-A5 04-6150-0120 K-2012 Gooseneck Boom Kit K-2013 Pneumatic Pump Kit K-2953 Hand Winch Kit
POWER PLANT - ATA 71
08-4049-0013

Sikorsky
S-61
TOWING & TAXIING - ATA 9
01-1201-0010-B2 01-618-0000 (R) 01-1185-0006 01-1185-0011 TTR-6
ELECTRICAL POWER - ATA 24
11-2820-0000
HYDRAULIC POWER - ATA 29
5211-EB (base model) 5211-C (R) KHC-1005 KHC-4020

For detailed model information reference the items page(s) • Bracketed # = quantity • R = required

Sikorsky		Sikorsky
S-76 (AUH-76)		S-92
LIFTING & SHORING - ATA 7	FUSELAGE - ATA 53	LIFTING & SHORING - ATA 7
02-0511C0132 Main (2) 02-0511C0132 Nose 02A7898C0100 Main (2) 02A7898C0100 Nose 02-7947C0000	04-6028C0121 K-3057 Crane Hook (R) 04-6029-5111 04-6029-5111-A5 04-6150-0120 K-2012 Gooseneck Boom Kit K-2013 Pneumatic Pump Kit K-2953 Hand Winch Kit	02-0517C0140 Fwd (2) 02-0517C0140 Aft 02-7816C0100 Axle 02-7947C0000
TOWING & TAXIING - ATA 9	POWER PLANT - ATA 71	TOWING & TAXIING - ATA 9
01-1202-0000 01-0516-0000 (R) 01-1127-0000 01-1127-0006 01-1220-0000 01-1285-0000 01-1390-0000 01-1950-5000 01-1954-6000 01-1954-6002 TTR-6	08-0147C4000 08-0104-4000 08-2023-0010 K-2108 (R) 08-4048-0013 K-1953 (R) K-4464 (R)	01-1202-0000 01-0599-0010 (R) 01-1215-0000 01-1325-0100 01-1402-0000 01-1954-6000 01-1954-6002 TTR-6
PARKING & MOORING - ATA 10		SERVICING - ATA 12
99-9028-6000		ENGINE OIL
SERVICING - ATA 12		06-5009C6800 06-5022-6800 06-5042-0800
ENGINE OIL		HYDRAULIC FLUID
06-5009C6800 06-5022-6800 06-5042-0800		06-5009C6800 06-5010-6800 06-5022-6800
HYDRAULIC FLUID		HELIUM
06-4005-0511 06-4035-0500 06-5022-6500 06-5042-0500		18-4306-0000
NITROGEN		HYDRAULIC FLUID
18-4201-1010 18-4208-0010 18-4303-0000 18-4315-0000 18-4318-0000 PC-1107 K-3706		06-4005-0511 06-4035-0500 06-5022-6500 06-5042-0500
ELECTRICAL POWER - ATA 24		SHIMMY DAMPER
11-2820-0000 11-6602-1000 11-6610-6000 112850 112860 92-0552-9010		06-5056-1D00
FUEL - ATA 28		NITROGEN
07-3000-1921 07-3005-6900		12-3104-0000 18-4201-1010 18-4208-0010 18-4303-0000 18-4315-0000 18-4318-0000 PC-1107 K-3706
HYDRAULIC POWER - ATA 29		ELECTRICAL POWER - ATA 24
5221-EA (base model) 5221-D Split System 5221-EQ (w/ flareless) KHC-1004 KHC-1020 KHC-4020		11-2820-0000 11-6602-1000 11-6610-6000 112850 112860 92-0552-9010
ICE & RAIN - ATA 30		FUEL - ATA 28
09-6200-0010		07-3000-1921 07-6006-6900 07-3009-6900 07-3015-0900
LANDING GEAR - ATA 32		HYDRAULIC POWER - ATA 29
14-6801-0120 Z-1063-09 Main (R) Z-1063-08 Tail (R) 14-6802-6000 14-6804-6000 14-6805-6010 14-6806-6011 14-6807-6011 14-6808-6000 14-6883-0110 14-6909C0000 14-4039-0010		5J41-CS (base model) KHC-3827 KHC-4033
		ICE & RAIN - ATA 30
		09-4003-4010
		LANDING GEAR - ATA 32
		14-6801-0120 Z-1063-11 (R) 14-6802-6000 14-6804-6000 14-6805-6010 14-6806-6011 14-6807-6011 14-6808-6000 14-6892-6000
		FUSELAGE - ATA 53
		04-6029-5111 04-6029-5111-A5 04-6150-0120 K-2012 Gooseneck Boom Kit K-2013 Pneumatic Pump Kit K-2953 Hand Winch Kit
		POWER PLANT - ATA 71
		08-4049-0013 K-3979 (R)

Sino Swearingen	
SJ30-2	
LIFTING & SHORING - ATA 7	FUSELAGE - ATA 53
02-7947C0000	04-6028C0121
TOWING & TAXIING - ATA 9	K-3057 Crane Hook (R)
01-1202-0000	Z-4082 Lift Tray (R)
01-0506-0000 (R)	06-6029-5111
01-1109-0010	06-6029-5111-A5
01-1259-0000	04-6152-0120
01-1950-5000	K-2012 Gooseneck Boom Kit
01-1954-6000	K-2013 Pneumatic Pump Kit
01-1954-6002	K-2953 Hand Winch Kit
eJP-3	POWER PLANT - ATA 71
eJP-3L	08-0119-8000
TTR-6	08-2021C0000
PARKING & MOORING - ATA 10	K-2032
99-9028-6000	08-2220C0000
SERVICING - ATA 12	08-4048-0013
ENGINE OIL	
06-5009C6800	
06-5010-6800	
06-5022-6800	
06-5042-0800	
HYDRAULIC FLUID	
06-4005-0511	
06-4035-0500	
06-5009C6800	
06-5010-6800	
06-5022-6500	
06-5042-0500	
NITROGEN	
18-4200-1100	
18-4208-0010	
18-4303-0000	
18-4315-0000	
18-4318-0000	
PC-1107	
K-3706	
OXYGEN	
20-4500-7000	
20-4502-6000	
20-4504-7000	
20-4505-7000	
20-4523-0000	
20-4525-0000	
PC-1006	
PC-1124	
AIR CONDITIONING - ATA 21	
15_7603-1000 (base model)	
15-7605-6010	
K-3317 (R)	
ELECTRICAL POWER - ATA 24	
11-2820-0000	
11-6602-1000	
11-6610-6000	
112850	
112860	
92-0552-9010	
FUEL - ATA 28	
07-3000-1921	
07-3006-6900	
HYDRAULIC POWER - ATA 29	
5241-AN (base model)	
KHC-1015	
ICE & RAIN - ATA 30	
09-4003-4010	
09-6200-0010	

Tripod Jack Proof Load Tester

TRIPOD JACK PROOF LOAD FIXTURE

Standard Features:

Model: 027935C0000

Designed to test the hydraulic load and pressure relief valve of tripod jacks

- Digital readout of load
- 100,000 lb maximum load capacity
- Collapsed Height: 10 in (25.4 cm)
- Collapsed Width: 26 in (66 cm)
- Weight: 80 lb (36 kg)
- Finish: Durable Powder Coat Tronair Blue

02-7935C0000



02-7947C0000



PORTABLE TRIPOD JACK PROOF LOAD TESTER

Standard Features:

Model: 02-7947C0000

Designed to test the hydraulic load and pressure relief valve of tripod jacks

- Digital readout of load
- 70,000 lb maximum load capacity
- Height: 102.4 in (140 cm)
- Weight: 1,635 lb (742 kg)
- Finish: Durable Powder Coat Tronair Blue



Accessories:

- K-5198 - Jacking Pedestal Kit allows testing of axle jacks

Specifications:

Model Number	To Test Jacks (base model number)
02-7935C0000	02A7889C0100, 02A7890C0100, 02A7895C0100, 02A7896C0100, 02A7897C0100, 02A7904C0100, 02A7922C0100, 02A7945C0100
02-7947C0000	02-0222C0111, 02-0234-0111, 02-0511C0132, 02-0517C0140, 02-0520C0110, 02-0522C0141, 02-0524C0110, 02-0526C0110, 02-0527C0140, 02-0536C0110, 02-0540C0110, 02-0544C0110, 02-0566C0110, 02-1032C0111, 02-1036C0111, 02-1040C0111, 02-1240C0111, 02-1248C0112, 02-1256C0111, 02-2560C0111, 02-7800C0110, 02-7802C0111, 02-7803C0111, 02-7804C0110, 02-7805C0111, 02-7809C0110, 02-7810C0111, 02-7812C0110, 02-7815C0110, 02-7822C0110, 02-7823C0110, 02-7827C0110, 02-7828C0110, 02-7837C0110, 02-7838C0110, 02-7839C0111, 02A7843C0112, 02-7844C0111, 02-7845-0120, 02-7848-0120, 02-7849-0120, 02-7851C0111, 02-7855C0100, 02-7856C0100, 02A7858-0100, 02-7865C0100, 02A7874C0110, 02A7885C0100, 02A7886C0100, 02-7898C0100, 02-7899C0100, 02A7904C0100, 02A7912C0100, 02A7913C0100, 02A7917C0100, 02A7917C0150, 02-7928C0100, 02A7930C0100, 02-8130C0100

TRIPOD JACK PAD ADAPTORS

Tronair jacks are equipped with a cupped jack Adaptor to interface with most aircraft jack pads. Aircraft requiring a special jack pad are listed below

Manufacturer	Aircraft	Part Number	Quantity Required
Agusta	A-109 (Main All)	R-1187-01	2
	A-109 (Nose All)	R-1187-02	1
ATR	42/72 (Nose)	R-1239	2
Bombardier	deHavilland Buffalo (Tail)	Z-3626	1
	deHavilland Dash-8 100, 200, 300 (Main & Nose)	R-1117	3
	deHavilland Dash-8 400 (Main)	R-1988	2
	deHavilland Dash-8 400 (Nose)	R-1117	1
Cessna	Citation Excel, CJ4, 525 & 525A (Main)	R-1798	2
	Citation Excel, CJ4, 525 & 525A (Nose)	R-2008	1
	Citation III, VI, VII (Main)	R-1276	2
	Citation X (Main)	R-1807	2
	Citation X (Nose)	R-1808	1
Embraer	EMB 120 (Main)	R-1276	2
Fokker	F-27 (Nose)	R-1474	1
Pilatus	PC6 (Main & Nose)	K-3583	1
	PC12 (2 Main & 1 Tail)	K-3582	1
	Turbo Islander (Main)	R-1034	2
Raytheon	BeechJet/Diamond (Main & Nose)	HJ-557	3
	Premier (Nose)	K-3692	1
Sikorsky	Seahawk, Jayhawk, Blackhawk (Tail)	R-1961	1

TRIPOD JACK EXTENSIONS

Standard Features:

These tripods provide additional heights for our 5-ton single stage tripod jacks.

- Tubular steel tripod weldment
- Expand your jack extended height
- Bolts securely to the jack for stability
- Finish: Durable Powder Coat Tronair Blue

Specifications:

Model Number	Height in (cm)	Jack
03-4026-0040	40 (101.6)	*02-0526C0110
03-5832-0000	12 (30.5)	* 02-0526C0110
03-5833-0000	18 (45.7)	* 02-0526C0110
03-5834C0000	18 (45.7)	* 02-0536C0110
03-5835-0000	12 (30.5)	* 02-0532-0110
03-5836-0000	14 (35.6)	02-7856C0100
03-5837-0000	34 (86.4)	* 02-0532-0110
03-5838-0000	36 (91.4)	02-7856C0100

* For other jacks contact the Sales Department for further details



03-5833-0000

Tripod Jacks

Standard Features:

- Hand pump with factory preset built-in pressure relief valve
- Air pump on all models with an "A" as the third digit of the model number (e.g. 02A1036-0111)
- Threaded rams with improved hand wheel style safety nut (except on 02-0222C0111 and 02-0234-0111 jacks)
- Quick rising center extension (except on 2, 25 and 30 ton jacks)
- Easy access filler/breather cap
- Spherical radius cup jack pads
- Heavy duty wheels on all jacks where spring loaded casters are not standard
- Hydraulic fluid: MIL-PRF-5606
- Finish: Durable Powder Coat Tronair Blue



CE Approved Jack:

Insert a "C" as the eighth digit, (e.g. 02-0517C0140) 

Accessories:

- Air Pump Kit (field installed) - call factory
- Air Pump (factory installed)
insert an "A" as the third digit of the model number (e.g. 02A1036-0111)
- Air Pump & Spring Loaded Casters (factory installed)
insert a "B" as the third digit of the model number (e.g. 02B0136-0111)
- Spring Loaded Casters (factory installed)
insert a "C" as the third digit of the model number (e.g. 02C1036-0111)
Not standard on 5 ton jacks
- K-1106 (field installed)
air pump manifold kit, supplies air from a single source to three tripod jacks via three 25 ft (7.6 m) hoses for operating air pumps
- K-1317 (field installed)
adds spring loaded casters to all 5 ton single stage jacks; except Model 02-7856C0100 use K-2812; one kit required per jack
- K-1318 (field installed) - adds spring loaded casters to Model 02-1032-0111; one kit required per jack
- K-1319 (field installed) - adds spring loaded casters to Model 02-1036-0111
- K-2812 (field installed) - spring loaded casters for models 02-0517C0140 and 02-7828C0110 (one each per jack)
- K-4220 (field installed) - air pump manifold kit, supplies air from a single source to four tripod jacks via four 25 ft (7.6 m) hoses for operating air pumps
- H-2395 (field installed) - jack cover (universal)

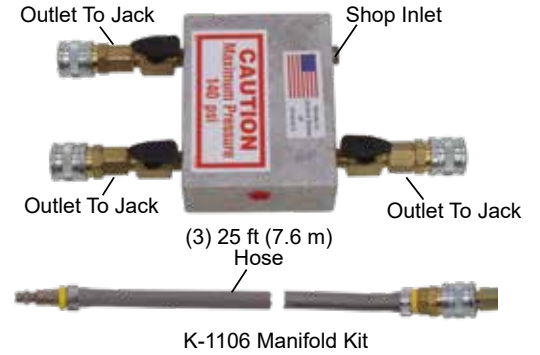

HAND WHEEL SAFETY NUT

Standard Features:

- Designed for speed and locking of tripod jacks
- Ensures safe operation of tripod jacks
- Cast handle completely surrounds the pinch point
- Outside Diameter:
H-2331, H-2334 & H-2335..... 8 in (20.3 cm)
K-3218..... 10 in (25.4 cm) & 12 in (30.5 cm)
K-3236..... 8 in (20.3 cm) & 10 in (25.4 cm)

SAFETY NUT - One nut per jack
H-2331 - 10 & 12 Ton Single Stage Jacks
H-2334 - 5 Ton Single Stage Jack
H-2335 - 5 Ton Two Stage Jack

SAFETY NUT KITS - One kit per jack
(kit includes a second stage safety nut)
K-3218 - 18, 25 & 30 Ton Single Stage Jacks
K-3236 - 10 & 12 Ton Two Stage Jacks





02-7866-0100



02-0511C0132



02-7822C0110



02A7898C0100



02-0566C0110

Additional Standard Features By Model Number:

- 1 Floor Jack
- 2 Spring Loaded Casters
- 3 Spring Loaded Casters & Towbar
- 4 Spring Loaded Locking Caster, Adjustable Leveling Feet with Leveling Bubble, Sight Gauge
- 5 Spring Loaded Locking Caster, Adjustable Leveling Feet with Leveling Bubble, Sight Gauge & Towbar
- 6 Spring Loaded Locking Caster, Adjustable Leveling Feet with Leveling Bubble, Towbar, Operator Platform & Ladder
- 7 Load Bearing Casters (see Tool & Equipment List Dash-7, F-27 & ATR 42/72)
- 8 Accessory: 03-5400-000 Leg Extension - increases maximum raised height to 92 in (234 cm)
- 9 Collapsible

Specifications:

	Model Number	Capacity tons	Stage Single (S) Multi (M)	Closed Height in (cm)	Mechanical Extension in (cm)	Hydraulic Extension in (cm)	Fully Extended in (cm)	Weight lb (kg)
	02-7866-0100	400 lbs	M	27 (69)	NA	29 (74)	55 (140)	470 (213)
	02-0222C0111	2	S	23 (58)	12 (30)	11 (28)	46 (117)	70 (32)
8	02-0234-0111	2	S	34 (86)	22 (56)	23 (58)	79 (201)	94 (43)
	02-0300C0100	2.5	S	17 (43)	NA	NA	32 (82)	600 (272)
1	02-0511C0132	5	M	11 (29)/17.5 (44.5)	3 (8)/6 (8)	12 (31)	26.6 (67)/32.7 (83)	100 (45)
2	02A7898C0100	5	M	11.6 (29.5)	3 (8)	17.5 (44.45)	32 (81)	162 (73.5)
	02-0517C0140	5	M	17 (43)	7 (18)	22 (56)	46 (117)	105 (48)
	02-0520C0111	5	S	20 (51)	6 (15)	12 (30)	38 (97)	90 (41)
	02A0520C0110	5	S	20 (51)	6 (15)	12 (30)	38 (97)	90 (41)
	02-0522C0141	5	M	22 (56)	7 (18)	22 (56)	51 (130)	113 (51)
	02-7828C0110	5	M	22 (56)	7 (18)	29 (74)	58 (147)	113 (51)
9	02-7928C0100	5	M	22 (56)	8 (20)	29 (74)	59 (149.9)	180 (82)
	02-0524C0110	5	S	24 (61)	8 (20)	16 (41)	48 (122)	98 (44)
	02-0526C0110	5	S	26 (66)	8 (20)	16 (41)	50 (127)	84 (38)
	02-7838C0110	5	S	26 (66)	8 (20)	16 (41)	50 (127)	84 (38)
7	02-7822C0110	5	M	27 (69)	9 (23)	34 (86)	70 (178)	140 (64)
	02-0527C0140	5	M	27.4 (69.5)	9 (23)	34 (86)	70.8 (179.9)	129 (58.7)
	02-7827C0110	5	M	27.4 (69.5)	9 (23)	34 (86)	70.8 (179.9)	129 (58.7)
	02-7856C0100	5	S	30 (76)	12 (30)	22 (56)	64 (163)	105 (48)
	02-0536C0110	5	S	36 (91)	10 (25)	22 (56)	68 (173)	110 (50)
2	02-7837C0110	5	M	38 (97)	9 (23)	34 (86)	81 (206)	190 (86)
2	02-0540C0110	5	S	40 (102)	10 (25)	22 (56)	72 (183)	115 (52)
2	02-0544C0110	5	S	44 (112)	10 (25)	22 (56)	76 (193)	125 (57)
2	02-7812C0110	5	S	54 (137)	10 (25)	30 (76)	94 (239)	185 (84)
2	02-0566C0110	5	S	66 (168)	10 (25)	22 (56)	98 (249)	140 (64)
2	02-7855C0100	5	S	84 (213)	10 (25)	22 (56)	116 (295)	190 (86)
2	02-7804C0110	5	S	100 (254)	10 (25)	22 (56)	132 (335)	190 (86)
	02-7865C0100	6	M	24 (61)	7 (18)	29 (74)	60 (153)	110 (50)
	02-8130C0100	6	M	24 (61)	7 (18)	29 (74)	60 (153)	110 (50)
	02A7934C0100	7	M	17.75 (45)	6 (15)	22 (56)	45.75 (116)	135 (61)
	02A7978C0100	7.5	M	35.9 (91)	---	48.7 (123.7)	80 (203.2)	588 (266.7)

Tripod Jacks



02-7809C0110



02-7815C0110



02-1248C0112



02-7802C0111

Additional Standard Features By Model Number:

- 1 Floor Jack
- 2 Spring Loaded Casters
- 3 Spring Loaded Casters & Towbar
- 4 Spring Loaded Locking Caster, Adjustable Leveling Feet with Leveling Bubble, Sight Gauge
- 5 Spring Loaded Locking Caster, Adjustable Leveling Feet with Leveling Bubble, Sight Gauge & Towbar
- 6 Spring Loaded Locking Caster, Adjustable Leveling Feet with Leveling Bubble, Towbar, Operator Platform & Ladder
- 7 Load Bearing Casters (see Tool & Equipment List Dash-7, F-27 & ATR 42/72)
- 8 Accessory: 03-5400-000 Leg Extension - increases maximum raised height to 92 in (234 cm)
- 9 Collapsible

Specifications:

	Model Number	Capacity tons	Stage Single (S) Multi (M)	Closed Height in (cm)	Mechanical Extension in (cm)	Hydraulic Extension in (cm)	Fully Extended in (cm)	Weight lb (kg)
2	02A7950C0100	10	M	14 (36)	8.6 (22)	22.6 (57)	45 (114)	284 (129)
2	02-7809C0110	10	M	22 (56)	4 (10)	23 (58)	49 (124)	250 (113)
3	02A7848C0120	10	M	28 (71)	12 (30)	33 (85)	72.5 (184)	286 (130)
2	02-7815C0110	10	M	28 (71)	12 (30)	33 (85)	72.5 (184)	271 (123)
3	02A7845C0120	10	M	29.75 (75.6)	13.5 (34)	48 (123.7)	91 (231.6)	444 (201)
	02-1032C0111	10	S	32 (81)	12 (30)	16.25 (41)	60.25 (153)	164 (74)
	02-1036C0111	10	S	36 (91)	14 (36)	20 (51)	70 (178)	185 (84)
2	02-1040C0111	10	S	38 (97)	14 (36)	24 (61)	78 (198)	220 (100)
2	02A7914C0100	10	S	41 (104)	8 (20)	25 (63.5)	74 (188)	500 (227)
2	02-1240C0111	12	S	40 (102)	14 (36)	24 (61)	78 (198)	220 (100)
3	02-7842C0100	12	M	40 (102)	12 (30)	40 (102)	92 (234)	350 (159)
3	02A7858-0100	12	M	40 (102)	12 (30)	47 (119)	99 (252)	350 (159)
5	02A7922C0100	12	M	48 (122.2)	6 (15)	55 (138)	107 (272)	850 (386)
2	02-1248C0112	12	S	48 (122)	14 (36)	30 (76)	92 (234)	269 (122)
2	02-7810C0111	12	S	48 (122)	14 (36)	30 (76)	92 (234)	269 (122)
	02-7800C0110	12	S	55 (138)	14 (36)	32 (82)	100 (256)	370 (160)
2	02-1256C0111	12	S	56 (142)	14 (36)	32.25 (82)	102.25 (260)	284 (129)
5	02A7958C0100	12	S	60 (152)	5 (13)	35 (89)	100 (256)	850 (386)
4	02A7890C0100	12	S	64 (162.6)	4 (10)	35 (89)	103 (261.6)	850 (386)
2	02A7859C0110	12	M	70 (178)	4 (10)	58 (147)	132 (335)	525 (238)
2	02-7802C0111	12	S	108 (274)	14 (36)	32 (82)	154 (391)	500 (227)
	02-8112C0111	12	S	108 (274)	14 (36)	32 (82)	154 (391)	500 (227)



02A7874C0110



02A7895C0100



02A7897C0100

Additional Standard Features By Model Number:

- 1 Floor Jack
- 2 Spring Loaded Casters
- 3 Spring Loaded Casters & Towbar
- 4 Spring Loaded Locking Caster, Adjustable Leveling Feet with Leveling Bubble, Sight Gauge
- 5 Spring Loaded Locking Caster, Adjustable Leveling Feet with Leveling Bubble, Sight Gauge & Towbar
- 6 Spring Loaded Locking Caster, Adjustable Leveling Feet with Leveling Bubble, Towbar, Operator Platform & Ladder
- 7 Load Bearing Casters (see Tool & Equipment List Dash-7, F-27 & ATR 42/72)
- 8 Accessory: 03-5400-000 Leg Extension - increases maximum raised height to 92 in (234 cm)

Specifications:

* 145 psi (10 bar) required for air pump for jack to reach maximum extension height

	Model Number	Capacity tons	Stage Single (S) Multi (M)	Closed Height in (cm)	Mechanical Extension in (cm)	Hydraulic Extension in (cm)	Fully Extended in (cm)	Weight lb (kg)
3	02A7912C0100	15	M	20 (51)	4 (10)	35 (89)	59 (150)	390 (177)
3	02A7917C0100	15	M	20 (51)	4 (10)	35 (89)	59 (150)	390 (177)
5	02A7949C0100	15	M	40 (102)	16 (41)	52 (133)	107 (272)	1,277 (579)
5	02A7896C0100	15	S	54 (137)	12 (30)	40 (102)	106 (269)	920 (417)
2	02A7869C0100	15	M	64 (163)	4 (10)	71 (180)	140 (356)	1,145 (519)
6	02A7897C0100	15	S	100 (254)	12 (30)	40 (102)	152 (386)	1,280 (581)
2	02-7839C0111	18	S	120 (305)	16.5 (42)	42 (107)	178.5 (453)	905 (410.5)
2	02A7874C0110	20	M	39 (99)	4 (10)	51 (130)	94 (239)	645 (293)
2	02A7843C0112	25	S	49 (124)	25 (64)	30 (76)	104 (264)	480 (218)
2	02-2560C0111	25	S	60 (152)	16 (41)	42 (107)	118 (300)	590 (268)
2	02A7868C0100	25	S	68 (172)	4 (10)	50 (127)	121.6 (308.9)	1,160 (526)
4	02A7889C0100	25	S	93 (237)	4 (10)	35 (89)	132 (335)	920 (417)
2*	02A7913C0100	30	M	46 (117)	4 (10)	39 (99)	89 (226)	800 (363)
2	02-7844C0111	30	S	46 (117)	16.5 (42)	27 (69)	89.5 (227)	420 (190.5)
5	02A7945C0100	30	S	72 (183)	30 (76)	45 (114)	145 (368)	1,500 (680)
5	02A7895C0100	40	S	60 (152)	16 (41)	44 (112)	120 (305)	1,380 (626)
5	02A7895C0100-A1	40	S	60 (152)	16 (41)	44 (112)	120 (305)	1,380 (626)
2	02A7850C0100	60	S	60 (152)	24 (61)	44 (112)	128 (325)	1,300 (590)

Telescoping Hydraulic Axle Jacks

Standard Features:

- Hand pump with pressure relief valve
- Easy access filler/breather cap that can be sealed to avoid spills
- Spacer blocks provide easy adjustment of closed height (included with some models)
- Finish: Painted Tronair Blue

CE Approved Jack:

Insert a "C" as the eighth digit, (e.g. 02-7813C0100)

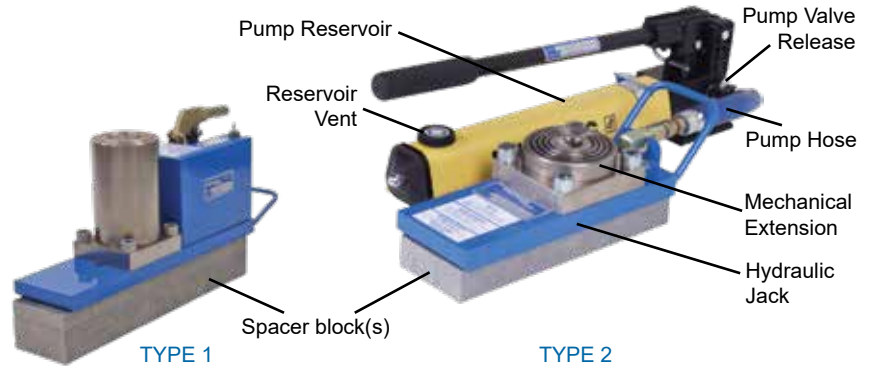

Accessories:

- 02-4950-4000 - Strut restrictor & axle jack adaptor for Citation III aircraft
- K-4026 - CE conversion kit for 02-7813C0100
- K-4296 - NLG adaptor pad

Specifications:

	Model Number	Capacity tons	Closed Height in (cm)	Mechanical Extension in (cm)	Hydraulic Extension in (cm)	Fully Extended in (cm)	Dimensions			Type
							Length in (cm)	Width in (cm)	Weight lb (kg)	
4, 6, 7	02-7902C0100	2	4 (10)	N/A	6.4 (16.2)	12 (30)	15.4 (39)	4.5 (11)	47.6 (21.6)	2
	w/out jack pad	12	4 (10)	N/A	6.4 (16.2)	12 (30)	15.4 (39)	4.5 (11)	52 (24)	2
1	02-7924C0100	4	3.5 (9)	N/A	3.7 (9.4)	7.21 (18.31)	11.3 (29)	4.5 (11)	32 (15)	2
	w/offset adapter	3.25	3.5 (9)	N/A	3.7 (9.4)	7.21 (18.31)	11.3 (29)	4.5 (11)	32 (15)	2
	02-7933C0100	5	5.63 (14.3)	2.63 (6.7)	9.25 (23.5)	17.5 (44.4)	17.25 (43.8)	3 (8)	36 (16.3)	1
3, 6, 7	02-7863C0100	12	3 (8)	1.5 (4)/2.75 (7)	3.4 (8.6)	15.4 (39)	15.4 (39)	4.5 (11)	47.6 (21.6)	2
5	02-7833C0110	12	3 (8)	N/A	N/A	8 (20)	15.4 (39)	4.5 (11)	60.5 (27)	2
2, 6	02-7852C0100	12	3 (8)	N/A	5.3 (13.5)	8.3 (21)	15.4 (39)	4.5 (11)	66 (25)	2
	02-7846C0100	12	3.75 (9.5)	N/A	N/A	11.6 (59.5)	15.4 (39)	4.5 (11)	32 (14.5)	1
	02-7832C0110	12	4 (10)	1.5 (4)	5.5 (14)	11.5 (29)	19 (48)	4 (10)	50 (23)	1
	02-7836C0110	12	4 (10)	1 (3)	6 (15)	11 (28)	15 (38)	4 (10)	60 (27)	1
6	02-7861C0100	12	3.75 (9.5)	1 (3)	8 (20)	12.6 (32)	15.4 (39)	4.5 (11)	50 (23)	2
	02-8126C0100	12	4 (10)	1.4 (3.5)	5.5 (14)	11 (28)	25 (64)	4.5 (11)	84 (38)	2
	also includes	25	6.5 (16.5)	2.75 (7)	7.9 (20)	17 (43)	25 (64)		84 (38)	2
	02-7854C0110	12	4 (10)	1.4 (3.5)	5.5 (14)	11 (28)	25 (64)	4.5 (11)	84 (38)	2
	also includes	25	7 (18)	3 (8)	9 (23)	19 (48)	25 (64)		84 (38)	2
	02-8126C0100	12	4 (10)	1.56 (3.96)	5.44 (13.8)	11 (28)	19.75 (50)	5 (12.7)	90 (41)	2
	also includes	26	6.6 (16.8)	3.13 (8)	8.3 (21)	18.4 (47)	25.4 (64.5)		90 (41)	2
3	02-8124-0100	12	4.5 (11)	4.5 (11)	6 (15)	15 (38)	17 (43)	4 (10)	61 (28)	1
3	02-7813C0100	12	4.5 (11)	4.5 (11)	6 (15)	15 (38)	17 (43)	4 (10)	61 (28)	1
3	02-7884C0100	12	4.6 (11.7)	4.5 (11)	6 (15)	15 (38)	17.5 (44.5)	4 (10)	61 (28)	1
	02-7862C0100	12	5 (13)	2 (5)	6 (15)	14 (36)	17 (43)	4 (10)	56 (25)	2
6	02-7834C0111	12	6 (15)	1.5 (4)	6 (15)	13 (33)	14 (36)	4 (10)	60 (27)	2
6	02-7818C0110	20	8.25 (21)	5 (13)	6 (15)	19 (48)	21 (53)	4.5 (11)	110 (50)	1
3	02-7825C0110	20	8.25 (21)	5 (13)	6 (15)	19 (48)	21 (53)	4.5 (11)	110 (50)	1

- 1 3/4" Base Plate included - increases closed and extended heights by 3/4"
- 2 1-1/2" Base Plate included - increases closed and extended heights by 1-1/2"
- 3 1" and 2" Spacer Blocks included - increases closed and extended heights by 1" & 2"
- 4 1/2" and 3/4" Spacer Blocks included - increases closed and extended heights by 1/2" & 3/4"
- 5 1/2", 3/4" and 1-1/2" Spacer Blocks included - increases closed and extended heights by 1/2", 3/4" & 1-1/2"
- 6 Carrying case included
- 7 Main and nose landing gear jacks pads included

Telescoping Hydraulic Axle Jacks

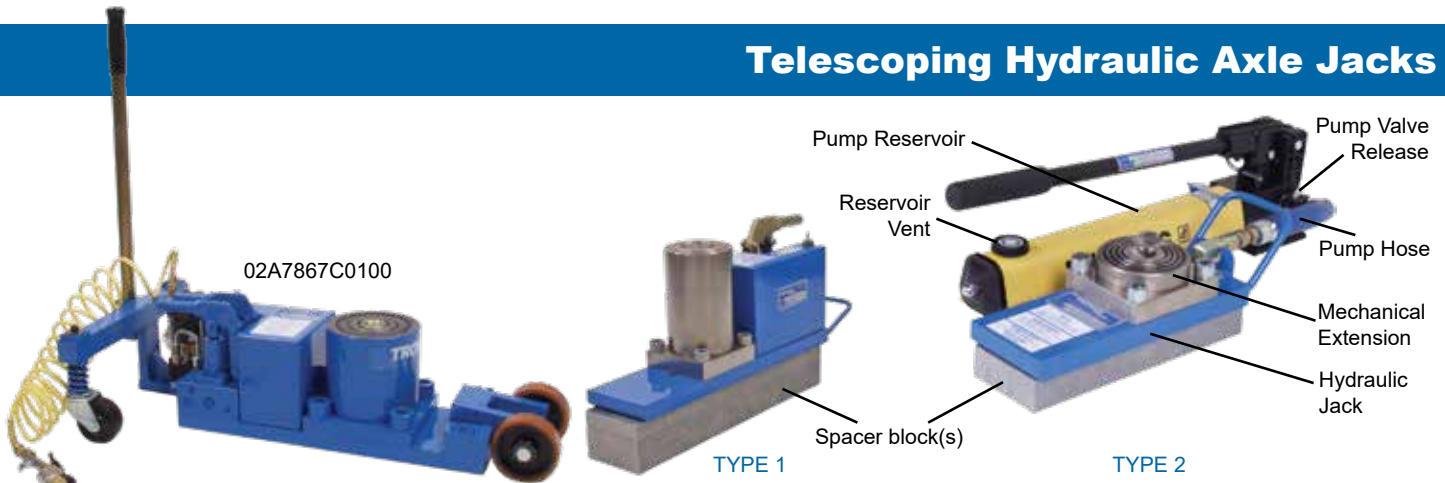

Specifications:

	Model Number	Capacity tons	Closed Height in (cm)	Mechanical Extension in (cm)	Hydraulic Extension in (cm)	Fully Extended in (cm)	Dimensions			Type
							Length in (cm)	Width in (cm)	Weight lb (kg)	
2	02-7925C0100	25	5.75 (14.6)	1.4 (3.5)	9.4 (24.8)	16.4 (41.76)	23 (58)	4.5 (11)	60 (27)	1
2	02-7830C0110	25	8 (20)	5 (13)	6 (15)	19 (48)	21 (53)	4.5 (11)	66 (30)	1
2	02-7901C0100	25	8 (20)	5 (13)	6 (15)	19 (48)	21 (53)	4.5 (11)	66 (30)	1
2	02-7960C0100	25	8 (20)	5.25 (13)	6 (15)	19.38 (49)	17.25 (43.8)	4.5 (11)	66 (30)	1
2	02-7835C0100	25	8.5 (22)	4.5 (11)	12 (30)	25 (64)	22.5 (57)	4.5 (11)	99 (45)	1
	02A7867C0100	30	7.5 (19)	4 (10)	11 (28)	22.5 (57)	33 (84)	7 (18)	150 (68)	1
5	02A7867C0100-A1	30	7.5 (19)	4 (10)	11 (28)	22.5 (57)	33 (84)	7 (18)	150 (68)	1

2 1" and 2" Spacer Blocks included - increases closed and extended heights by 1" & 2"

5 Includes load gauge

Aircraft Recovery Dolly

Standard Features:

- Simple operation, can be managed by one (1) person
- Heavy structural steel construction, durable
- 33 in (83.8 cm) maximum aircraft wheel width
- 42° maximum turning angle
- Solid rubber tires
- Front and rear wheels pivot allowing dolly to be lowered for ease of loading
- Four (4) steel skid wheels for final positioning
- Expanded metal steel reinforced storage tray
- Towbar with forged eyebolt
- Self-leveling foot pads accommodate uneven towing surfaces
- Front and rear hydraulic systems
- Hand pumps require 35 lb. handle force to actuate total hydraulic cylinder movement
- Heavy duty chain pullers easily cinch aircraft tires
- Finish: Durable Powder Coat Tronair Blue



Specifications:

Model Number	Load Capacity lb (kg)	Max Towing Speed mph (kph)	Length in (cm)	Width in (cm)	Height in (cm)	Weight lb (kg)
02-4951-0100	16,000 (7,257)	5 (8)	177 (449.6)	60 (152.4)	20 (50.8)	1,200 (544.3)

Stabilizing Stands

03-4006-0000



03-4007-0000



03-4033-0000



03-5800C0010



A05386D



Standard Features:

- Stands stabilize aircraft when lifting with tripod jacks
- Padding on all adaptors that may come in contact with aircraft skin
- Welded steel tripod structure offers a sturdy and stable platform
- Casters on stabilizing stand weighing more than 40 lbs (18 kg)
- Quick action mechanical extension in increments of 1/4 inch
- Wide range of interface adaptors
- Finish: Durable Powder Coat Tronair Blue
- Stabilizing Stand Alarm (factory installed)
insert an "A" as the third digit of the model number, (e.g. 03A4006-0000)

CE Approved Stabilizing Stand:

Insert a "C" as the eighth digit, (e.g. 03-5815C0010)



Type C Standard Features:

- Stands stabilize aircraft during ground operation
- Load capacity 25,000 lb (11,339.8 kg)
- Dual 12 Volt and hand powered hydraulic system
- Ladder to aid in proper positioning
- Two casters on stand are locking
- Towable to 5 mph (8 kph) maximum
- Finish: Durable Powder Coat Tronair Blue

Specifications:

Type	Model Number	Manufacturer/Aircraft	Closed Height in (cm)	Extended Height in (cm)	Weight lb (kg)
C	A005386D	Boeing 747	197 (500.4)	275 (698.5)	1750 (794)
C	A004661D	Boeing 747 (galvanized)	197 (500.4)	275 (698.5)	1750 (794)
	03-4006-0000	Universal	30 (76)	72 (183)	28 (13)
	03A4007-0000	Cessna Citation I, II, V, S II, Bravo, Ultra (series 500, 501 & 550)	32 (81)	50 (127)	14 (6)
	03-4012-0000	Bombardier Dash-7	78 (198)	103 (262)	86 (39)
	03-4015-0000	IAI Westwind 1 & 2	34 (85)	54 (137)	18 (8)
	03-4033-0000	Hawker Beechcraft BeechJet (Diamond)	33 (84)	44 (112)	15 (7)
	03A5800C0010	BAe Jetstream 31 Bombardier Challenger, 600, 601, 604, CRJ-100/200 Dassault Falcon 50, 50EX	54 (137)	77 (196)	80 (36)
	03A5801-0010	Cessna Citation III, VI, & VII (series 650)	47 (119)	70 (178)	67 (30)
	03A5802C0000	Bombardier LearJet 23 thru 35 & 55 Cessna Caravan 208, 208B, 406 Embraer EMB-110	39 (99)	67 (170)	17 (8)
	03A5804C0010	Hawker Beechcraft Beech 99, C12, King Air, U-21 A/G, 1900	43 (109)	65 (165)	20 (9)
	03-5805-0000	Saab 340, 2000	48 (122)	65 (165)	70 (32)
	03-5806-0000	CASA CN-235	102 (259)	126 (320)	94 (43)
	03-5808-0000	BAe ATP CASA 212	84 (213)	120 (305)	103 (47)
	03A5809C0000	Bombardier LearJet 45 & 60 Gulfstream G-100 (Astra), G-150 (Astra SPX)	61 (155)	103 (262)	30 (13.6)

Specifications:

Model Number	Manufacturer/Aircraft	Closed Height in (cm)	Extended Height in (cm)	Weight lb (kg)
03-5813-0000	Piaggio P180	28 (71)	49 (124.5)	16 (7)
03-5814-0000	Fairchild/Dornier 328, 328JET, Envoy	98 (249)	158 (401)	120 (54)
03A5815C0010	Cessna CitationJet, CJ1 & CJ2 (series 525), Mustang	27 (68.6)	49 (124.5)	22 (10)
03-5816-0000	BAe Jetstream 41	67 (169)	87 (222)	85 (39)
03-5817-0000	Cessna Citation X (series 750)	49 (124)	72 (183)	76 (34)
03-5819-0000	Bombardier Dash-8-100/300 (Pre Modification: 8/1795)	47 (119)	70 (178)	75 (34)
03-5820-0000	Bombardier Dash-8-100/300 Aircraft 1 thru 23 (Pole)	40 (102)	N/A	4 (2)
03-5821-0000	Bombardier Dash-8-100/300 (Post Modification: 8/1795)	48.18 (122.38)	81.68 (207.47)	75 (34)
03A5822C0000	Bombardier Challenger 300, Global Express Dassault Falcon 900, 2000 Hawker Beechcraft Premier	68 (173)	104 (264)	90 (41)
03-5824-9000	Bombardier Lear C-21 Tailpost	33 (84)	57 (145)	12 (5)
03-5825-0110	Bombardier Canadair CRJ700	66.75 (169)	125.25 (318)	600 (272)
03A5826-0000	Cessna Citation Excel series 550XL	42 (107)	68 (173)	62 (28)
03-5828-0000	Bombardier CRJ700, CRJ900, CRJ1000	65 (165)	105 (267)	105 (48)
03A5829C0000	Bombardier Dash-8-400	80 (203)	106 (269)	110 (50)
03-5830-0000	Hawker Beechcraft HS125	70 (178)	106 (269)	90 (41)
03A5831-0000	Cessna Citation Sovereign 680	54 (137)	77 (196)	80 (36)
03A5840C0100	Falcon 7X	54.56 (138.6)	76 (193)	94 (239)
03-5842C4000	Cessna Mustang 510	29 (74)	34 (86)	11 (5)
03A5845C0000	Embraer Legacy	60.63 (154)	87.63 (222.6)	150 (68)
03A5846C0100	Bombardier CSeries	75 (190.5)	130 (330)	410 (186)
03A5849C0000	Bombardier Global 7000/8000	67 (170)	120 (305)	135 (61)
03-5851-0000	Honda Honda Jet	34.625 (88)	55 (139.7)	30 (13.6)
03-5855C0000	Dassault Falcon 7X	44 (112)	59 (150)	80 (36)
03A5858C0000	Cessna SkyCourier 408	55.5 (141)	85.5 (217)	90 (41)
03A5860C0000	Bombardier Global 7000/8000	80 (203)	123 (312)	164 (74)
03A8561C0000	Pilatus PC-24	47.625 (121)	81 (205.7)	75 (34)

STABILIZING STAND ALARM KITS

Designed as an early warning device to sound a 85 dB alarm when a load of 100 lbs (45 kg) or greater is put on the stabilizing stand.

	Fits Stabilizing Stands:					
K-3863	03-4007-0000	03-4015-0000	03-4033-0000	03-5815-0000	03-5804-0010	
K-3864	03-4012-0000	03-5800C0010	03-5801-0010	03-5805-0000	03-5806-0000	03-5816-0000
	03-5818-0000	03-5819-0000	03-5821-0000	03-5822C0000	03-5826-0000	03-5828-0000
	03-5829-0000	03-5830-0000	03-5855C0000	03-8016-0010	03-8127-0000	
K-3892	03-5817-0000					



JETporter Electric Towbarless Tugs



Standard Features:

Models: eJP-3, eJP-3L

- Battery charge indicator with hourmeter and diagnostics
- Built in 12-24-28/30V power supply to assist starting aircraft engines
- GPU cable and plugs
- Two speed transmission
- 6 Hp continuous duty motor
- 48V, 25A DC on-board battery charger 120/230 VAC 50/60 Hz - eJP-3
- 48V, 50A DC stand alone battery charger - eJP-3L
- Order for voltage and frequency needed, single or 3 phase (charger ordered seperately)
- Regenerative braking through motor control
- Automatic parking brake
- Emergency safety cut off switch
- Covered storage compartments with rubberized coating on aluminum diamond deck cover
- Nylon wheel tie down safety strap
- Nylon winch strap
- Nylon strut strap
- Headlights and rear facing lights
- Strobe light
- Fire extinguisher
- Horn
- Finish: Tronair Blue (Custom colors & graphics available)



Accessories:

- | | | |
|----------|--|--------------|
| • K-4050 | Front Pintle Hitch (Slide In) | eJP-3/eJP-3L |
| • K-4057 | Standoff Arm
(for aircraft w/wheel pants) | eJP-3/eJP-3L |
| • K-4094 | Jumper Cable Kit | eJP-3/eJP-3L |
| • K-4052 | Westwind 1 & 2 Adaptor | eJP-3/eJP-3L |
| • K-4053 | MU2 (Solitaire only) Adaptor | eJP-3/eJP-3L |
| • K-4054 | PC 12 Adaptor | eJP-3 |
| • K-5388 | Falcon 50/900/2000 Adaptor | eJP-3/eJP-3L |
| • K-5387 | Learjet 40/70/75 Adaptor | eJP-3/eJP-3L |
| • K-4177 | Sabreliner Adaptor | eJP-3/eJP-3L |

Specifications:

Model Number	Max Aircraft Weight lb (kg)	Cradle Capacity lb (kg)	Speed Empty mph (kph)	Speed Full Load mph (kph)	Length in (cm)	Width in (cm)	Height in (cm)	Weight lb (kg)
eJP-3	30,000 (13,608)	3,000 (1,361)	10 (16)	3 (4.8)	135 (342.9)	40 (101.6)	49 (124.5)	2,450 (1,111)
eJP-3L	30,000 (13,608)	3,000 (1,361)	10 (16)	3 (4.8)	171 (434.4)	40 (101.6)	49 (124.5)	3,250 (1,474)

Standard Features:

- 3 year/3,000 hour warranty
- Zero degree turning technology
- Zero-emission 72V AC electric drive
- Dual drive motors
- Sit down model
- Programmed electric motor braking with brake pedal
- 2 drive motors coupled directly to torque hubs result in fewer moving parts
- Aircraft selection system to limit torque
- Oversteer (over-torque) protection system
- 72 volt 430AH battery system - eJP-10
- 72 volt 440AH battery system - eJP-12
- Battery watering kit
- Power steering
- Heavy duty long life torque hubs
- Regenerative motor braking on deceleration
- Automatic parking brake
- Controlled acceleration & deceleration foot operated throttle
- Proportional drive with steering position sensor
- Rear suspension system
- Hydraulic system filtration
- Digital display with diagnostics
- Steering position indicator
- Emergency safety cut off switch
- Covered storage compartments with coated aluminum diamond deck cover
- Solid rubber tires
- Sealed winch tension safety switch with no mechanical linkage
- Wheel tie down safety strap
- Nylon winch strap
- Nylon strut strap
- Fire extinguisher
- Strobe light
- Horn
- LED Side marker lights
- LED Headlights and rear facing lights
- Pintle hitch (rear)
- Recommended - ECO Charge battery charger (not included)
- Finish: Tronair Blue (Custom colors and graphics available)



Accessories:

- K-4052 Westwind 1 & 2 Adaptor eJP-10
- K-5388 Falcon 50/900/2000 Adaptor eJP-10/eJP-12
- K-5387 Learjet 40/45 Adaptor eJP-10/eJP-12
- K-5389 Falcon 7X/8X Adaptor eJP-10/eJP-12
- K-4177 Sabreliner Adaptor eJP-12
- "Smart charging" battery system
- Waterproof cradle camera and display
- Custom paint scheme

Chargers:

Customer to define required voltage and frequency for hangar

- EC-3106 Series, 3 PH - eJP-10
- EC-3113 Series, 1 PH - eJP-10
- EC-3237 Series, 3 PH - eJP-12

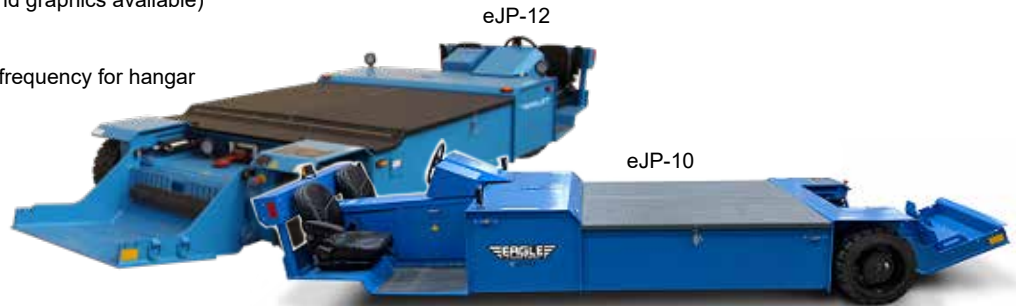

Specifications:

Model Number	Max Aircraft Weight lb (kg)	Cradle Capacity lb (kg)	Speed Empty mph (kph)	Speed Full Load mph (kph)	Length in (cm)	Width in (cm)	Height in (cm)	Weight lb (kg)
eJP-10	100,000 (45,359)	10,000 (4,536)	7 (11.3)	3 (4.8)	209 (530.9)	70 (177.8)	39 (98.4)	6,600 (2,994)
eJP-12	125,000 (56,699)	12,500 (5,669)	7.5 (12)	3 (4.8)	220 (559.3)	78 (198)	39 (98.4)	9,500 (4,309)

ETT SERIES ELECTRIC AWD AIRCRAFT TUGS

The eTT Series is the next generation of eco-friendly, zero emissions electric tow tractor. Powered by an environmentally-friendly 80V A/C electric drive. The eTT Series vehicles combine a low profile design and ergonomic operator compartments with front and rear hitch sight tunnels for safe and efficient aircraft handling. Eagle eTT Series aircraft tugs pack a significant amount of value into a robust, compact vehicle with many standard features. The optional "Smart Charge" battery and charger system allows the battery to be opportunity charged to maximize efficiency, with no reduction in battery life-cycle.

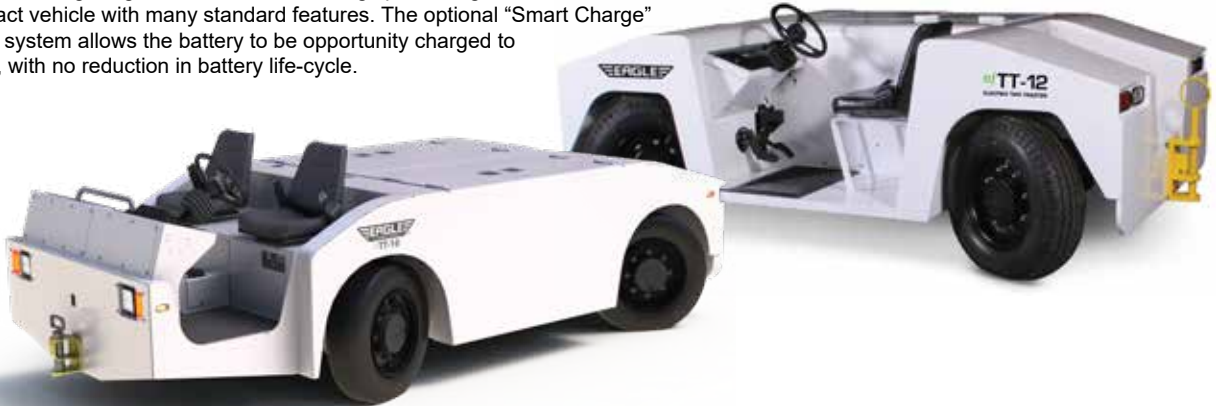

Standard Features:

- 3 year/3,000 hour warranty
- Zero-emission 80V A/C electric drive
- Four wheel drive
- Front and rear inching switches
- Hitch sight tunnels
- Easy access electric motor
- Max unloaded speed: 12 mph (19 kph)
- Max loaded speed: 3 mph (4 kph)
- Power steering and braking
- Hydraulic power-boosted, 4-wheel coordinated steering
- Front and rear disc brakes
- Electric regenerative primary brakes
- Hydraulic wet disc supplementary brakes
- Parking brake
- A/C brushless traction motor
- Rated Power @ 1300 rpm: 56 hp (42 kW)
- Rated Torque: 210 ft-lbs (284 Nm)
- LED headlights / LED brake, tail and back-up / LED markers
- Instruments: Electronic display showing speed, battery life, hours and diagnostics
- 80V D/C on-demand, sensor monitored hydraulic pump

Optional Equipment:

- "Smart charge" batteries and charger system
- Front and rear e-hitch
- Heated cab
- Custom paint scheme

Eagle TTR Series - Safe Handling Chart

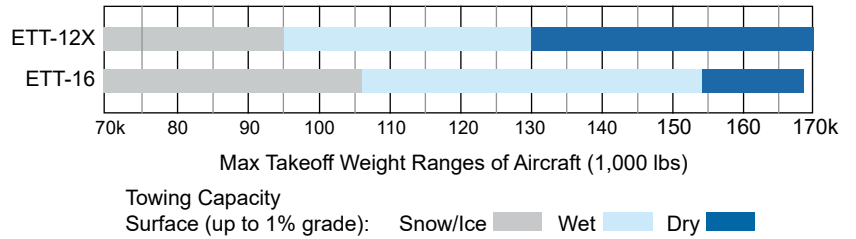

Feature	ETT-8X	ETT-12XX	ETT-16
Wheelbase	75 in (190 cm)	75 in (190 cm)	90 in (228.6 cm)
Track	52 in (132 cm)	52 in (132 cm)	63 in (160 cm)
Turning Radius	135 in (342 cm)	135 in (342 cm)	154 in (391.2 cm)
Ground Clearance	6 in (15 cm)	6 in (15 cm)	9 in (22.8 cm)
Rated Power	26 hp (20kW)	53 hp (40 kW)	56 hp (42 kW)

Specifications:

Model Number	Max Tow (1% Grade)			Drawbar Pull lbf (kN)	Length in (cm)	Width in (cm)	Deck Height in (cm)	Service Weight		
	Dry lb (kg)	Wet lb (kg)	Snow lb (kg)					w/Led-Acid batteries lb (kg)	w/Lithium batteries lb (kg)	w/out batteries lb (kg)
ETT-8X	115,000 (52,200)	85,000 (38,600)	60,000 (27,000)	8,000 (35.8)	148.5 (377)	60.5 (154)	55 (140)	10,800 (4,899)	8,700 (3,311)	7,300 (3,311)
ETT-12X	168,000 (76,204)	130,000 (59,000)	95,000 (43,091)	12,000 (54)	148.5 (377)	60.5 (154)	55 (140)	14,600 (6,622)	13,700 (6,214)	11,100 (5,035)
ETT-16	171,000 (77,564)	154,000 (69,853)	113,000 (51,256)	12,000 (54)	166 (422)	54 (137)	43 (109)	16,800 (7,260)	N/A	12,600 (5,715)

*Calculations assume 1% grade. Severity of Grades and Surface Conditions will affect towing capabilities. Snow rating assumes the use of cables.

TTR SERIES AWD AIRCRAFT TUGS

The TT Series vehicles combine a low profile design and ergonomic operator compartments with strong visibility and sight-lines for safe and efficient aircraft handling. Eagle TT Series aircraft tugs pack a significant amount of value into a robust and compact vehicle with many standard features.



Standard Features:

- Tier 4 Final compliant
- All wheel drive
- 2 Front / 2 Rear drive wheels
- Side and top access to engine
- Low oil/high temp engine protection shutdown
- Keyless ignition with anti-restart
- Wheelbase
TTR-6 & TTR-8: 84 in (213.5 cm)
TTR-12: 92 in (233.5 cm)
- Track:
TTR-6 & TTR-8: 57 in (145 cm)
TTR-12: 61.8 in (157 cm)
- Ground Clearance: 8 in (20 cm)
- Max unloaded speed
TTR-6 & TTR-8: 23 mph (37 kph)
TTR-12: 17 mph (27 kph)
- Max loaded speed
TTR-6 & TTR-8: 4.3 mph (6.9 kph)
TTR-12: 3.7 mph (5.9 kph)
- Power steering and braking
- Power-assisted hydrostatic, self centering steering
- Parking brake override protection
- Hydraulic, self-adjusting split type brakes with accumulator
- Front disc brakes
- TTR-6 & TTR-8: Rear drum brakes
TTR-12: Rear disc brakes
- 14.9 gal (56.4 l) fuel tank
- Severe environment, heavy duty, dry replacement element air cleaner
- Battery (cold crank) 850 amp
- Rear hitch spotlight
- Post mounted strobe light
- Recessed full LED lights
- Instruments: Dual-unit digital back-lit display offering engine/tractor diagnostics and full instrumentation

Optional Equipment:

- Limited slip rear axle
- Heated cab
- 2,000 hour preventative maintenance kit
- Front and rear e-hitch
- Heavy duty stainless steel chock basket
- Backup alarm
- Chassis turn signals & front hitch spotlight
- Rubber deck protectors
- Towbar and head storage rack
- Wing walker platform
- Custom paint scheme

Specifications:

Model Number	Max Tow (1% Grade)			Drawbar Pull lbf (kN)	Length in (cm)	Width in (cm)	Height in (cm)	Service Weight	
	Dry lb (kg)	Wet lb (kg)	Snow lb (kg)					Gas/Lpg lb (kg)	Diesel lb (kg)
TTR-6	85,000 (38,555)	75,000 (34,019)	50,000 (22,680)	6,000 (26.7)	116 (294)	54 (137)	40 (102)	6,200 (2,812)	6,400 (2,903)
TTR-8	115,000 (52,163)	85,000 (38,555)	60,000 (27,216)	8,000 (35.6)	116 (294)	54 (137)	40 (102)	7,000 (3,175)	7,200 (3,266)
TTR-12	171,000 (77, 564)	130,000 (59,000)	90,000 (41,000)	12,000 (53.8)	116 (294)	54 (137)	40 (102)	8,100 (3,674)	8,300 (3,765)

Height with cab (option) - 71 in (180 cm)

Weight with cab (option) - add 500 lbs (227 kg)

*Calculations assume 1% grade. Severity of Grades and Surface Conditions will affect towing capabilities. Snow rating assumes the use of cables.

Eagle TTR Series - Safe Handling Chart

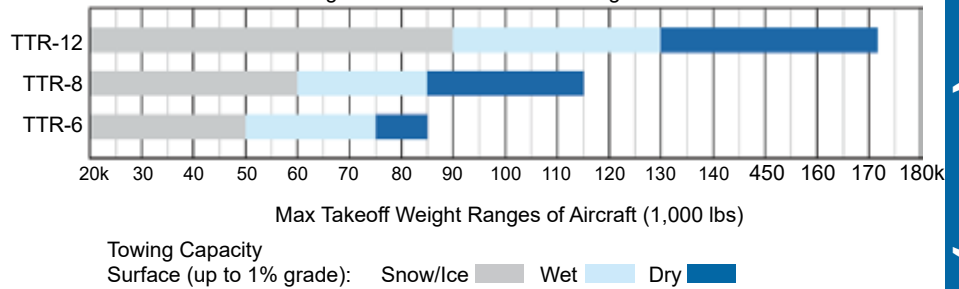

Towing Capacity
Surface (up to 1% grade): Snow/Ice Wet Dry

Engine Options	TTR-6 & TTR-8	TTR-12
	EPA emissions compliant	
Manufacturer/Model	Kohler/ KDI 1903TCR	Kohler/ KDI 2504TCR
Rated Power @ 2600 rpm	56 hp (42 kW)	75 hp (55 kW)
Rated Torque @ 1500 rpm	166 ft-lbs (225 Nm)	221 ft-lbs (300 Nm)
Cylinders - Displacement	3 Cylinder / 1.86 L	4 Cylinder / 4.48 L
System Voltage	12 volt	12 volt
Alternator	80 amp	80 amp

Eagle Tugs

XL and XM SERIES AIRCRAFT TUGS

The XL Series is your full solution for moving single-aisle aircraft (up to B757-size)
 The XM Series is a workhorse for moving all variations of 737 and A320 aircraft



Eagle XL and XM Series - Safe Handling Chart

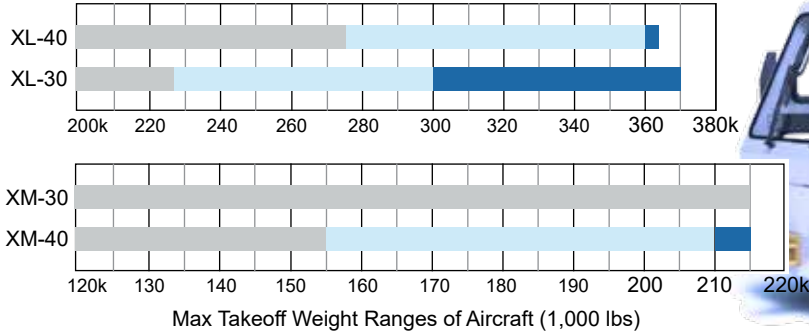

Towing Capacity
 Surface (up to 1% grade): Snow/Ice Wet Dry

XL Standard Features:

- 3 year/3,000 hour warranty
- Non EPA emissions compliant
- Four wheel drive
- 2 Front / 2 Rear drive wheels
- Low oil/high temp shutdown system
- "Hot shift" transmission protection
- Wheelbase: 91 in (231 cm)
- Track: 83 in (210.8 cm)
- Ground Clearance: 9 in (22.8 cm)
- Max speed governed: 19 mph (30 kph)
- Hydraulic 4-wheel coordinated steering
- Four wheel steering with crab steering
- Emergency stop
- Front and rear wet disc brakes
- Mechanical dry disc (rear axle) parking brake
- 30 gal (11 l) fuel tank
- Rated Power @ 2500 rpm: 120 hp (89 kW)
- Rated Torque @ 2800 rpm: 354 ft-lbs (480 Nm)
- Cylinders - Displacement: 4 cylinder / 3.6 L
- Severe environment, heavy duty, dry replacement element air cleaner
- 12 volt system
- 95 amp alternator
- Two batteries (cold crank) 850 amp each
- Keyed ignition with anti-restart
- Recessed LED headlights / LED brake, tail and back-up
- Maker/strobe lights
- Instruments: Dual-unit digital back-lit display offering engine diagnostics and full instrumentation

Optional Equipment:

- Heated cab
- 2,000 hour preventative maintenance kit
- Front and rear multi-level hitch
- Custom paint scheme

XM Standard Features:

- 3 year/3,000 hour warranty
- EPA emissions compliant
- Four wheel drive
- 2 Front / 2 Rear drive wheels
- Low oil/high temp shutdown system
- "Hot shift" transmission protection
- Wheelbase: 93 in (236 cm)
- Track: 75.5 in (191.7 cm)
- Ground Clearance: 8 in (20.3 cm)
- Max speed governed: 18 mph (29 kph)
- Hydraulic assisted steering
- Emergency stop
- Front and rear wet disc brakes
- Spring-applied with manual override (front and rear) parking brake
- 22 gal (83 l) fuel tank
- Rated Power @ 2500 rpm: 74 hp (55 kW)
- Rated Torque @ 1600 rpm: 221 ft-lbs (300 Nm)
- Cylinders - Displacement: 4 cylinder / 3.3 L
- Severe environment with pre-cleaner, heavy duty, replaceable element air cleaner
- 12 volt negative ground system
- 70 amp alternator
- Battery (cold crank) 850 amp
- External battery disconnect
- Keyed ignition with anti-restart
- Recessed LED headlights / LED brake, tail and back-up
- Maker/strobe lights
- Instruments: J1939 compliant analog face with digital engine diagnostics module

Optional Equipment:

- Heated cab
- 2,000 hour preventative maintenance kit
- Front and rear multi-level hitch
- CE compliance kit (European customers)
- Custom paint scheme

Specifications:

Model Number	Max Tow (1% Grade)			Drawbar Pull lbf (kN)	Length in (cm)	Width in (cm)	Deck Height in (cm)	Service Weight Diesel lb (kg)
	Dry lb (kg)	Wet lb (kg)	Snow lb (kg)					
XL-30	370,000 (167,829)	300,000 (136,078)	215,000 (97,522)	26,000 (116)	175.5 (445.8)	201 (510.5)	52 (132)	32,000 (14,500)
XL-40	362,000 (164,200)	360,000 (163,293)	275,000 (124,738)	26,000 (116)	175.5 (445.8)	201 (510.5)	52 (132)	32,000 (14,500)
XM-20	215,000 (97,522)	210,000 (92,950)	155,000 (70,300)	16,000 (71.2)	175.5 (445.8)	85 (216)	46 (116.8)	24,000 (10,880)
XM-30	215,000 (97,522)	215,000 (97,522)	215,000 (97,522)	16,000 (71.2)	175.5 (445.8)	85 (216)	46 (116.8)	32,000 (14,500)

*Calculations assume 1% grade. Severity of Grades and Surface Conditions will affect towing capabilities. Snow rating assumes the use of cables.

Standard Features:

- Welded steel construction
- Positive locking to towbar via a ball lok T-pin
- Shear protection, both radial and/or compression/tension built in to protect nose gears as required
- Finish: Durable Powder Coat Tronair Blue



Specifications: 500 and 600 Series Standard Attachment Heads

For towbars listed on page 80

Model Number	Manufacturer/Aircraft	Length in (cm)	Weight lb (kg)
01-0400-0000	Bombardier Dash-8-400 (fits towbar 01-1201-0010 only)	20.187 (53)	35 (16)
01-0502-0010	Raytheon Hawker HS-125-100 to 800	15.625 (40)	15 (7)
01-0503-0000	Sabreliner (all)	16.25 (41)	13 (6)
01-0505-0000	Dassault Falcon 10-100, 20-200 & HU-25A	17.937 (46)	30 (14)
01-0506-0000	Sino Swearingen SJ30-2 Raytheon Beech 99, 1900, King Air, Queen Air, 90, 100, 200, 300 & 350, C-12, T-44, 1900	20.5 (52)	18 (8)
01-0507-0000	Fairchild Dornier Metro Merlin III & IV	20.5 (52)	18 (8)
01-0508-0000	Mitsubishi MU2	27.625 (70)	22 (10)
01-0511-0000	Cessna Cessna 210, Centurion, 310, 320, 335, 340, 401, 402, 401 & 411, Skymaster 336 & 337 Titan Gulfstream Aero & Turbo Commander Piper Cheyenne I, II & III, IIIA, 400LS, Aerostar, Chieftain, Navajo, Mojave	20.5 (52)	18 (8)
01-0513-0000	Bombardier Dash-6 Twin Otter, UV-18A	27.625 (70)	22 (10)
01-0514-0000	Fokker F-27 Friendship	17.75 (45)	19 (8.6)
01-0515-0000	Bombardier Challenger 601, 604	16.187 (43)	21 (9.5)
01-0516-0000	Sikorsky S-76, AUH-76	27.75 (70)	22 (10)
01-0517-0000	Bombardier Dash-7	17.625 (45)	30 (14)
01-0518-0010	Shorts SD330, SD360 & C-23A	28.75 (73)	26 (12)
01-0520-0010	Dassault Falcon 50, 50EX, 900, 900EX, 2000 & 2000EX	17.937 (46)	28 (13)
01-0522-0000	Britten Norman Islander, Trislander	25.25 (64)	18 (8)
01-0524-0000	Agusta A-109 (all)	20.5 (52)	20 (9)
01-0525-0000	Bell Helicopter 222, 230, 430	20.5 (52)	18 (8)
01-0526-0000	BAe Jetstream 31	16.125 (41)	13 (6)
01-0529-0000	Nomad Nomad	27.75 (70)	22 (10)
01-0531-0000	Casa C212, C212C, C212-200 Aviocar	28.375 (72)	32 (15)
01-0532-0000	BAe HS-748	31 (79)	44 (20)
01-0534-0000	Fairchild Dornier 228-100/200	22.625 (57)	24 (11)
01-0535-0000	Bell 214, 214 ST	17.062 (43)	13 (6)
01-0538-0000	Cessna Caravan 208, 208B & 406	27.875 (71)	22 (10)
01-0539-0000	Northrop T-38	14.75 (37)	13 (6)
01-0540-0010	Embraer EMB-120	25.25 (64)	35 (16)
01-0542-0010	Cessna Citation CJ1, CJ2, CJ3, I (500), I/SP (501), II (550), SII, Bravo, Encore 560, Ultra (560), V, Mustang (510)	24.625 (62.5)	23 (10.4)
01-0543-0000	Raytheon BeechJet 400, Diamond, Premier	23.625 (60)	22 (10)
01-0544-0000	Bombardier Dash-6 Twin Otter (hi-float tires)	37.562 (95)	36 (16)
01-0545-0011	SAAB 340, 2000	23.75 (60)	30 (14)
01-0546-0000	Gulfstream I, II, III, IV, IV-SP, G300, G400	26.25 (67)	43 (20)
01-0547-0000	General Dynamics Convair 580 thru 640	31.25 (79)	37 (17)
01-0548-0000	Nihon YS-11	31.125 (77)	38 (17)
01-0549-0000	Dassault Falcon 10-100, 20-200 & HU-25A (w/radial shear)	21.625 (55)	39 (18)
01-0550-0000	Bombardier Challenger 600, 601, 604 (w/radial shear)	21.312 (54)	24 (11)
01-0551-0010	Shorts SD330, SD360 & C-23A (w/radial shear)	34.75 (88)	42 (19)
01-0552-0011	Casa CN-235	26.75 (68)	33 (15)
01-0554-0000	Embraer EMB-110	18 (46)	20 (9)
01-0555-0000	BAe ATP	16.625 (42)	35 (16)
01-0556-0000	Eurocopter Dauphin 2 – AS365N, EC-155	27.75 (70)	23 (10)
01-0558-0000	ATR ATR 42/72	20.625 (52)	30 (14)
01-0559-0000	Gulfstream G100 (Astra SP & SPX) IAI Westwind 1 & 2	30.125 (77)	23 (10)

Attachment Heads



01-0576-0000



01-0582-0011



01-0605-0000

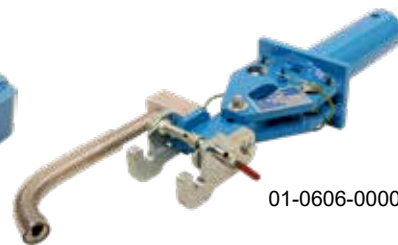

01-0606-0000

Specifications: 500 and 600 Series Standard Attachment Heads

For towbars listed on page 80

Model Number	Manufacturer/Aircraft	Length in (cm)	Weight lb (kg)
01-0560-0010	Dassault Falcon 50, 50EX, 900, 900EX, 2000 & 2000EX (w/radial shear)	20.75 (53)	35 (16)
01-0565-0000	BAe ATP (w/shear)	21.25 (54)	35 (16)
01-0566-0000	Fokker F-50 (w/radial shear)	24.125 (61)	45 (20)
01-0569-0000	Fokker F-50	19.5 (50)	40 (18)
01-0570-0010	Piaggio P-180 Avanti	27.75 (70)	22 (10)
01-0571-0011	Bombardier Canadair CRJ 100/200 Raytheon Hawker 4000 (w/radial shear)	30.375 (77)	45 (20)
01-0574-0010	Raytheon Hawker HS-125-100 to 10000 (w/radial shear)	20.312 (52)	20 (9)
01-0575-0011	BAe Jetstream 41 (w/dual shear)	20.625 (52)	19 (9)
01-0576-0000	Fairchild Dornier 328, 328JET, Envoy 3 Gulfstream G150	13.625 (35)	14 (6)
01-0577-0020	Eurocopter Puma AS330, AS332 Super Puma	28.25 (72)	32 (15)
01-0578-0010	Bombardier CL-215/415 (w/dual shear)	29.562 (75)	39 (18)
01-0579-0000	Russian Helicopter (Mil Moscow) Mi-8, Mi-17	10.187 (26)	17 (8)
01-0580-0000	Eurocopter Dauphin HH-65A	21.875 (56)	30 (14)
01-0582-0011	Embraer ERJ-135, ERJ-140, ERJ-145, Legacy	26.25 (67)	39 (18)
01-0586-0000	Bombardier Canadair CRJ 700	37.375 (95)	75 (34)
01-0590-0000	Bombardier Dash-8-100,300	20.25 (51)	33 (15)
01-0591-0000	Bombardier LearJet (all) (w/tension/compression shear) Cessna Citation I, II, V, S/II, CitationJet 525, Bravo, Ultra, Mustang 510	30.812 (78)	35 (16)
01-0594-0000	Cessna Citation III, VI, VII, X, 750, Excel & Sovereign	19.125 (49)	25 (11)
01-0595-0000	Raytheon JPATS T-6A Texan II	18.375 (47)	18 (8)
01-0597-0000	Bombardier Challenger 300	32.125 (82)	59 (27)
01-0598-0000	Eclipse Aerospace Eclipse 500	20.5 (52)	20 (9)
01-0599-0010	Sikorsky S-92	31 (78.7)	58.5 (26.5)
01-0602-0000	Dassault Falcon 7X (w/dual shear)	24.937 (63)	42 (19)
01-0603-0000	Hawker 4000	27.625 (69)	37 (17)
01-0604-0000	Embraer Phenom 300	21.43 (54)	14.3 (6.5)
01-0605-0000	Agusta AW139	27.062 (69)	37 (17)
01-0606-0000	Embraer Phenom 300	27.625 (70)	14 (6)
01-0607-0000	HondaJet HC-420	24 (61)	23.7 (10.8)
01-0608-0000	Bombardier LearJet 85 (w/radial shear)	33 (84)	49.8 (22.6)
01-0610-0000	ATR ATR 42/72 (w/shear)	32.75 (8.3)	72 (32.7)
01-0612-0000	Dassault Falcon 50, 50EX, 900, 900EX, 2000 & 2000EX (w/tension/compression shear)	23.5 (60)	37.5 (17)
01-0616-0000	Bell 525	24.25 (62)	26.5 (12)
01-0618-0000	Sikorsky Blackhawk S-61/S-70, Boeing Apache AH-64	28.875 (73)	28 (13)
01-0622-0000	Embraer Legacy 450/500	29.156 (74.1)	23 (10)
01-0624-0000	Embraer Phenom 100	28.5 (72.4)	24 (10.9)
01-0625-0000	Pilatus PC-12, PC-24	18.125 (46)	15 (6.8)
01-0626-0000	Cessna Citation CJ1, CJ2, CJ3, CJ4, I (500), I/SP (501), II (550), SII, Bravo, Encore 560, M2, Mustang (510), Ultra (560), V	24.625 (62.5)	23 (10.4)
01-0627-0000	Airbus Helicopter (Eurocopter) H160	28.625 (72.7)	26 (12)

Specifications: 800 Series Heavy-Duty Attachment Heads

For towbars listed on page 80

Model Number	Manufacturer/Aircraft	Length in (cm)	Weight lb (kg)
01-0801-0010	Bombardier Global Express, Global 5000/6000	39.5 (100)	60 (27)
01-0803-0000	Bombardier CRJ700, CRJ900 (See CRJ-700 01-0586-0000)	40 (102)	78 (35)
01-0806-0010	Gulfstream GIII, GIV, GV, GVSP, G350, G400, G450, G500, G550, G650	34.6 (87.8)	83 (37.6)
01-0810-0000	Bombardier Global 7000/8000	41.75 (106)	56 (25)
*01-0814-0000	Dassault Falcon 6X	24.4 (62)	37 (17)

* K-4187 adapter kit is required when attachment head is used with heavy-duty multi-head towbar

Multi-Head Towbar Systems

Multi-Head Towbar Systems Features:

- Attachment heads easily change and securely attach to towbar in seconds (see pages 83 & 84)
- Multi-head systems save space and capital investment
- Heavy duty welded aluminum construction
- Standard 2-3/16 in (5.6 cm) I.D. towing eye
 - 2-7/8 in (7.3 cm) I.D. eyebolt insert the letter "A" as the third digit of the model number (e.g. 01A1202-0000)
 - 3 in (7.62 cm) I.D. eyebolt insert the letter "B" as the third digit of the model number (e.g. 01B1202-0000)
- Positive locking pin secures attachment heads to towbar
- Both towbar and attachments adhere to aircraft manufacturer's towing specifications
- Finish: Durable Powder Coat Tronair Blue



Additional Standard Multi-Head Towbar Systems Features:

- Shock absorber protects nose gear during towing operation
- Pneumatic wheels to absorb towing speed shock
- Handles positioned in front and rear to lift towbar into position

Accessories:

- K-3785 - Rear Impact Caster Kit
- K-4074 - Towbar Hydraulic Lift Kit for towbar with 3 1/2" diameter tube
- K-4075 - Towbar Hydraulic Lift Kit for towbar with 4" diameter tube
- K-4076 - Towbar Hydraulic Lift Kit for towbar with 4 1/2" diameter tube



Additional Heavy Duty Multi-Head Towbar Systems Features:

- Heavy duty shock assembly with single spring for nose gear protection during towing operation
- 9 in (23 cm) pneumatic wheels with steel bearings and movable truck assembly
- Upright handle makes lifting easier

800 Series Heads Only
01-1270-0010



Accessories:

- K-3785 - Rear Impact Caster Kit
- K-4076 - Towbar Hydraulic Lift Kit for towbar with 4 1/2" diameter tube
- K-4187 - 500 Series Head Adaptor Kit (01-1270-0010 ONLY)

400, 500, 600 & 800 Series Heads
01-1290-0100



Specifications:

Model Number	Aircraft Weight Capacity lb (kg)	System	Length in (cm)	Width in (cm)	Weight lb (kg)	Wheel Size in (cm)
01-1201-0010	75,000 (34,019)	Standard	127 (323)	22 (56)	102 (46.3)	9 (22.9)
01-1201-0011	75,000 (34,019)	Standard	127 (323)	21.5 (55)	102 (46.3)	6 (15.2)
01-1202-0000	66,000 (29,937)	Standard	127 (323)	22 (56)	92 (42)	9 (22.9)
01-1270-0010	125,000 (56,699)	Heavy Duty	128 (325)	23 (58)	122 (55)	10.6 (26.9)
01-1290-0100	125,000 (56,699)	Heavy Duty	128 (325)	24 (61)	155 (70)	9 (22.9)
01-1329-0000	85,000 (34,019)	Standard	159 5/8 (405)	23 (58)	132 (60)	10.6 (26.9)

Standard Features:

- Compact to provide away from home towing capacity
- Shear protection is included when required by aircraft manufacturer
- Lightweight
- Finish: Durable Powder Coat Tronair Blue

CE Approved Portable Towbars:

Insert a "C" as the eighth digit (e.g. 01-2001C0000)

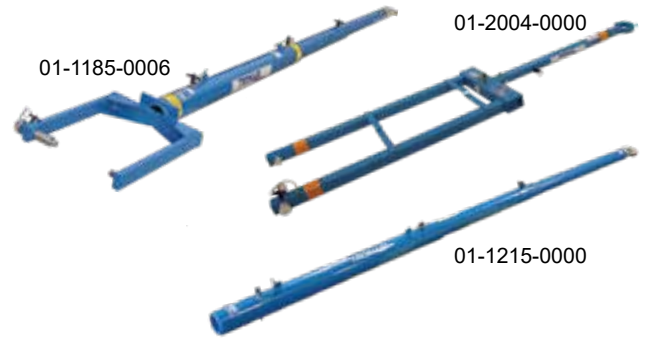

Specifications:

Model Number	Manufacturer/Aircraft	Material	Closed in (cm)	Extended in (cm)	Weight lb (kg)	Shear Protection
01-1127-0006	Sikorsky S-76	Steel	45 (114)	64 (163)	25 (11)	No
01-1134-0006	Bell 222, 230, 430	Steel	40 (102)	60 (152)	25 (11)	No
01-1148-0000	Eurocopter Dauphin AS 365N	Steel	47 (119)	66 (168)	31 (14)	No
01-1154-0000	Agusta A-109 (all)	Steel	41 (104)	60 (152)	28 (13)	No
01-1185-0006	Sikorsky S-61, MH-60S Seahawk, UH-60 Black Hawk	Aluminum	55 (140)	120 (306)	65 (30)	No
01-1196-0010	Bombardier Challenger 600, 601, 604	Aluminum	73 (185)	92 (234)	46 (21)	Yes
01-1215-0000	Universal (by use of attachment head) see pgs. 39 & 40	Aluminum	57 (145)	120 (305)	41 (19)	No
01-1216-0000	Universal (by use of attachment head) see pgs. 39 & 40	Aluminum	57 (145)	89 (226)	28 (13)	No
* 01-1221-0006	Sikorsky MH-60R, SH-60B/F, HH-60-H, HH-60J, S-70B	Aluminum	67 (170)	290 (737)	130 (59)	No
01-1227-0000	Piaggio Avanti P-180	Steel	61 (155)	102 (259)	56 (25)	No
01-1232-0000	Bell 412 (w/ retractable landing gear)	Steel	49 (124)	75 (191)	25 (11)	No
* 01-1236-0000	Fokker 70, 100	Aluminum	85 (216)	180 (457)	155 (70)	Yes
01-1239-0000	Bombardier Learjet 23, 24, 31, 31A, 35, 55	Steel	44 (112)	76 (193)	30 (14)	No
* 01-1253-0000	Gulfstream GII, GIII, GIV, GIVSP, G300, G400	Aluminum	52 (132)	61 (155)	41 (19)	Yes
01-1254-0000	Pilatus PC-12	Steel	70 (178)	120 (305)	32 (15)	No
* 01-1261-0000	Gulfstream GII-GV	Aluminum	50 (127)	86 (218)	55.5 (25)	No
01-1271-0000	Gulfstream Galaxy G-200	Aluminum	71 (180)	148 (376)	51 (23)	No
* 01-1275-0010	Bombardier Global Express	Aluminum	52 (132)	90 (229)	90 (229)	Yes
01-1282-0010	Bombardier CRJ-700	Aluminum	77 (196)	112 (285)	55 (25)	Yes
** 01-1287-9000	General Dynamics F-16, Lockheed Martin F-16	Aluminum	85 (215)	239 (606)	190 (86)	No
01-1292-0000	Cessna Citation III, VI, VII, X, 750, Sovereign, Excel	Aluminum	87 (221)	123 (312)	56 (25)	No
* 01-1296-0000	Bombardier Challenger 300	Aluminum	56 (142)	119 (302)	61 (28)	Yes
01-1328-0000	Bombardier CRJ-900	Aluminum	72 (183)	111 (282)	78.5 (36)	Yes
* 01-1332-0000	Embraer Lineage	Aluminum	58 (147)	211 (536)	177 (80.3)	Yes
* 01-1339-0000	Eurocopter Dauphin AS365N	Aluminum	58 (147)	146 (371)	91 (41)	No
* 01-1398C0000	Gulfstream G650	Aluminum	52.25 (133)	86 (218)	60 (27)	Yes
* 01-2007-0000	Embraer Phenom 300	Steel	36 (91)	92 (234)	30.5 (14)	Yes
01-2000-0000	Adam A500, A700	Aluminum	38 (96.5)	87.5 (222.3)	15 (6.9)	No
01-2001-0000	Eclipse 500	Aluminum	35.4 (89.9)	75.5 (192)	13.5 (6)	No
01-2002-0000	Embraer Phenom 100	Aluminum	37.5 (92.25)	91 (231)	26 (12)	Yes
01-2004-0000	Cessna Mustang 510	Aluminum	38 (96.5)	87.5 (222.3)	15 (6.9)	No
01-2006-0000	Piaggio P-180	Aluminum	61.5 (156)	105.5 (268)	25 (11)	No
01-2008-0000	Northrop Grumman Firebird	Aluminum	35.4 (89.9)	75.5 (192)	13 (6)	No
* 01A1275-0020	Bombardier Global Express	Aluminum	54 (137)	96 (244)	59 (27)	Yes
* 01A1302-0000	Embraer ERJ-170, ERJ-190	Aluminum	65 (166)	207 (526)	150 (68)	Yes
* 01A1332-0000	Embraer Lineage 1000	Aluminum	60.5 (154)	213 (541)	177 (80)	Yes
* 01B1302-0000	Embraer ERJ-170, ERJ-190	Aluminum	65 (166)	207 (526)	150 (68)	Yes
* 01B1365-0000	Bombardier Global 7500/8000	Aluminum	36 (91)	96 (224)	95.5 (43)	Yes

* Multiple section towbars, closed length is the length of the longest section

** Multiple section towbar, closed length is the length of the longest section, finish on this towbar is Powder Coat Olive Drab
 Closed - is the overall length of the unit when closed
 Extended - is the length from the center of the towing eye to the center of the sliding pins

Custom Towbars



Standard Features:

- Positive locking mechanism to aircraft tow point
- Heavy duty shock assembly with 2³/₁₆ in (5.6 cm) towing eye (to substitute a 2⁷/₈ in (7.3 cm) I.D. eyebolt insert the letter "A" as the third digit of the model number, e.g. 01A1212-0010)
- Handles provided to lift towbar into position
- Unpainted surfaces plated to resist corrosion
- Finish: Durable Powder Coat Tronair Blue

Special Features:

- 1 Radial shear
- 2 Tension/compression shear
- 3 Pneumatic tires
- 4 Solid tires
- 5 Rear casters
- 6 Movable front wheel assembly
- 7 Remote linkage connecting rod
- 8 Hydraulic actuated wheel assembly

Accessories:

- K-4074 - Landing Gear Assembly Kit for towbar with 3 1/2" diameter tube
- K-4075 - Landing Gear Assembly Kit for towbar with 4" diameter tube
- K-4076 - Landing Gear Assembly Kit for towbar with 4 1/2" diameter tube
- K-4499 - Converts 01-1308-0000 to 01-1308-0010 (accommodates new nose gear widths)

Specifications:

Model Number	Manufacturer/Aircraft	Material	Shock	Length in (cm)	Weight lb (kg)	Special Features
01-1101-0000	Cessna Citation I, II, V, S/II, CJ1, CJ2, Citation Jet, Ultra	Aluminum	Yes	143 (363)	88 (40)	2, 3, 7
01-1102-0010	Bombardier Learjet (all)	Aluminum	Yes	140 (356)	83 (38)	2, 3, 6
01-1106-0000	Gulfstream GI, GII, GIII, GIV, GIV-SP, G300, G400	Aluminum	Yes	144 (366)	120 (54)	2, 3, 5
01-1124-0000	BAe BAC I-II	Steel	No	223 (566)	228 (103)	3, 6
01-1127-0000	Sikorsky S-76	Aluminum	Yes	83 (211)	68 (31)	3, 7
01-1155-0000	Fairchild Dornier 228	Aluminum	Yes	102 (259)	76 (34)	1, 3, 5
01-1161-0009	BAe 146, RJ70, RJ85	Steel	N/A	142 (361)	145 (66)	2, 3, 6
01-1176-0010	Fokker F-28	Steel	Yes	178 (452)	148 (67)	2, 3, 6
01-1182-0010	Lockheed Jetstar	Aluminum	Yes	185 (460)	120 (54)	3, 5, 6
01-1183-0000	Dassault Falcon 10-100, 20-200	Aluminum	Yes	141 (358)	126 (57)	1, 2, 3, 5, 6
01-1185-0011	Boeing Apache AH 64 Sikorsky S-61, MH-60S Seahawk, UH-60 Black Hawk	Aluminum	Yes	193 (490)	142 (64)	3, 5, 6
01-1186-0000	Bombardier Challenger 600, 601, 604	Aluminum	Yes	141 (358)	118 (54)	1, 2, 3, 5, 6
01-1187-0011	Saab SF-340	Aluminum	Yes	143 (363)	110 (50)	2, 3, 5, 6
01-1189-0012	Casa CN-235	Aluminum	Yes	146 (366)	128 (58)	2, 3, 6
01-1193-0010	BAe ATP	Aluminum	Yes	138 (351)	130 (59)	1, 3, 5, 6
01-1208-9011 *	General Dynamics F-16 Lockheed Martin F-16	Aluminum	No	241.3 (612.9)	135 (61)	3, 5, 6
01-1210-0010	Eurocopter HH-65A Dolphin, SA-366G-1	Aluminum	Yes	172 (429)	94 (43)	3, 7
01-1211-0010	Dassault Falcon 50, 50EX, 900, 900EX, 2000, 2000EX	Aluminum	Yes	140 (358)	126 (57)	1, 2, 3, 5, 6
01-1220-0000	Sikorsky S-76	Steel	No	89 (226)	54 (25)	---
01-1224-0010	Lockheed C-130	Aluminum	No	163 (414)	130 (59)	3, 6
01-1229-0011	Bombardier CRJ-100/200 Hawker (Beech) Hawker 4000	Aluminum	Yes	146 (371)	120 (54)	1, 2, 3, 6
01-1231-0000	Alenia C-27J, G222	Aluminum	No	187.5 (476)	168 (76)	2, 3, 6
01-1234-0010	Saab 2000	Aluminum	Yes	143 (363)	140 (64)	2, 3, 5, 6
01-1242-0000	Sikorsky MH-60R, SH-60B/F, HH-60-H, HH-60J, S-70B	Aluminum	Yes	290 (737)	180 (82)	3, 5
01-1244-0000	Sikorsky S76C	Steel	No	55 (140)	27 (12)	---

*The Finish on this towbar is Powder Coat Olive Drab



Specifications:

Model Number	Manufacturer/Aircraft	Material	Shock	Length in (cm)	Weight lb (kg)	Special Features
01-1259-0000	Hawker Beechcraft King Air, Queen Air Sino Swearingen SJ30-2	Steel	No	136 (345)	85 (38.5)	4, 6
01-1261-0011 *	Gulfstream GII-GV	Aluminum	No	111 (282)	77 (35)	---
01-1262-0000	Gulfstream Astra, G100 IAI Westwind	Steel	No	142 (361)	85 (39)	3
01-1263-0000	Fairchild Dornier Metro III, IV	Steel	No	136 (345)	86 (39)	4, 6
01-1264-0000	Cessna Citation I, II	Steel	No	138 (351)	85 (38.5)	4, 6
01-1269-0020	Bombardier Global Express	Aluminum	Yes	152 (381)	173 (79)	2, 3, 6
01-1272-0000	Gulfstream G150, G200 (Galaxy)	Aluminum	Yes	178 (452)	126 (57)	3, 5, 6
01-1274-0030	Gulfstream V, V-SP, G350, G450, G500, G550	Aluminum	Yes	144 (366)	175 (79)	2, 3, 6
01-1280-0000	Casa C-295	Aluminum	Yes	153 (386)	180 (82)	1, 2, 3, 6
01-1281-0010	Bombardier CRJ-700/900	Aluminum	Yes	153 (381)	200 (91)	1, 2, 3, 6
01-1285-0000	Sikorsky S-76	Steel	No	85 (216)	54 (25)	4, 7
01-1291-0010	Cessna Bravo, Ultra, Citation III, VI, VII, Citation X, 750, Excel, Sovereign Series 680	Aluminum	Yes	138 (351)	116 (53)	2, 3, 6
01-1297-0100	Embraer ERJ-170/ERJ-175/ERJ-190/ERJ-195	Aluminum	Yes	206 (533)	250 (113)	1, 2, 3, 8
01-1299-0000	Cessna Excel 560	Aluminum	No	80 (240)	30 (14)	---
01-1300-0000	Dissault Falcon 10-100, 20-200	Aluminum	Yes	181 (460)	140 (64)	1, 3, 5, 6
01-1305-0000	Bombardier Canadair CRJ-700	Steel	No	149 (378)	145 (66)	1, 2, 4, 6
01-1308-0010 NSN: 1730015459830	General Atomics MQ-1 Predator, Predator B	Steel	No	144 (366)	59 (27)	1, 2, 4, 5
01-1310-0000	Casa CN235	Steel	Yes	146 (371)	190 (86)	2, 3
01-1317-0000	Airbus A380-700, 800, 800F, 800R, 900	Steel	No	144 (366)	700 (317.5)	1, 3, 8
01-1324-0000	Embraer Phenom 100	Steel	No	92.8 (235.7)	26 (12)	1, 2
01-1325-0100	Sikorsky S-92/H-92	Steel	No	176 (448)	240 (109)	2, 3, 8
01A1326-0100	Sukhoi SJ100	Aluminum	Yes	162 (411)	307 (139)	1, 2, 3, 8
01-1333-0000	Grob G120A	Steel	Yes	95.7 (243)	45 (20.4)	---
01-1335-0000	Boeing CH-47 Chinook	Aluminum	No	99.8 (253.5)	36 (16.3)	---
01-1336-0000	Embraer Lineage	Aluminum	Yes	209.3 (531.7)	233 (105.7)	1, 2, 3, 8
01-1338-0000	Eurocopter Dauh AS365N	Steel	No	145 (368)	151 (68.5)	---
01-1342-0000	KAI KUH	Steel	Yes	158.75 (403)	155 (70)	2, 3, 6
01-1354-0100	Gulfstream G150, G200, G280	Aluminum	Yes	181.44 (460.9)	160 (72.6)	3, 5, 8
01-1368-0000	Dissault Falcon 6X	Steel	No	80 (203)	23 (10.4)	---
01-1376-0000	Bell 525	Aluminum	Yes	143.4 (364)	116.8 (53)	2, 6
01-1390-0000	Sikorsky S-76	Steel	No	93.25 (237)	64 (29)	---
01-1394-0000SP	Lockheed F-16	Aluminum	Yes	244.5 (621)	250 (113)	1, 2, 3, 5, 6
01-1402-0000	Sikorsky S-92, VH-92	Aluminum	No	197.875 (502.6)	151.5 (68.7)	5, 7
01A1336-0100	Embraer Linage	Aluminum	Yes	211.5 (537)	236 (107)	1, 2, 3, 8
01B1399-0100	Embraer E190-E2, E195-E2	Aluminum	Yes	216.375 (549.4)	368 (167)	1, 2, 3, 8
A1321-0024	Aermacchi C27J, G-222	Aluminum	No	187.5 (476)	168 (76)	2, 3, 6

*The Finish on this towbar is Powder Coat Olive Drab

Commercial Towbars

Standard Features:

- Positive locking mechanism to aircraft tow point
- Hydraulic retractable undercarriage
- Tension/compression shear
- Steel towbar tube
- 3.25 in (8.26 cm) towing eye
- Unpainted surfaces zinc plated to resist corrosion
- Finish: Durable Powder Coat Tronair Blue

Specifications:

Model Number	Manufacturer/Aircraft	Head Style	Length in (cm)	Weight lb (kg)
01-1317-0000	Airbus A380-700/800/800F/800R/900	Clamp	141 (358)	650 (295)
01B1387-0100	Airbus A220-100/300	Clamp	215 (546)	350 (159)
A003686D	Boeing 727	Pin	202 (513)	350 (159)
A003806D	Boeing 777, 787	Clamp	143 (363)	650 (295)
A003813D	Boeing 757	Clamp	216 (549)	350 (159)
A003817D	Airbus A318, A319, A320, A321	Clamp	216 (549)	350 (159)
A003819D	Boeing 737-100 thru -900	Clamp	215 (546)	350 (159)
A003830D	Boeing 747	Pin	149 (378)	680 (308)
A004190D	Airbus A300, A310 Boeing 727	Clamp	202 (513)	350 (159)
A005265D	Airbus A340-500/600	Clamp	139 (353)	650 (295)
A005269D	Boeing 717, DC-9 McDonnell Douglas DC-9, MD80, MD88, MD90	Pin	170 (432)	382 (173)
A005384D	Boeing 717, DC-9 McDonnell Douglas DC-9, MD80, MD88, MD90	Pin	170 (432)	300 (136)
A212635D	Boeing 777	Clamp	143 (363)	630 (286)
A212636D	Airbus A330, A340-200/300, A350 Boeing 767, 777, 787, DC-10 Lockheed L-1011 McDonnell Douglas DC-10, MD11	Clamp	143 (363)	650 (295)

Standard Features:

- Patented snap-back feature allows towbar to flex when safe turning radius is exceeded
- Self-centering spring reduces stress to landing gear
- Designed to tow from manufacturer's recommended towing point
- Positive locking mechanism to aircraft
- Sturdy welded steel construction
- Lightweight for ease of carrying
- 3 in (7.6 cm) towing eyelet
- Finish: Durable Powder Coat Tronair Blue

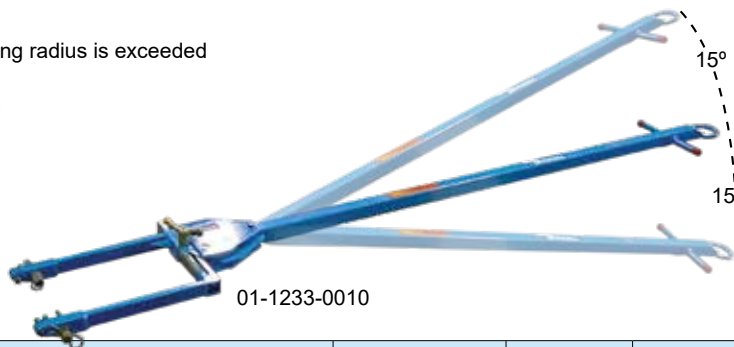

Specifications:

Model Number	Manufacturer/Aircraft	Capacity lb (kg)	Length in (cm)	Weight lb (kg)
01-1109-0010	Fairchild Dornier Merlin II Sino Swearingen SJ30-2 Raytheon Beech 99, 1900, C-12, T-34C, T-42A, U-21 A/G, King Air, Queen Air, Starship Universal Towbar	15,000 (6,804)	88 (224)	37.4 (17)
01-1112-0010	Cessna Bravo, Cardinal RG, Citation I, II, V, S/II, 310, 320, 337 Skymaster, 340, 401, 402, 411, 414, 421, 414A, 421C Gulfstream Turbo Commander, Aero Commander Mooney all Piper Cheyenne I, II & III, Chieftain, Navajo Universal Towbar	16,000 (7,258)	86 (218)	37 (17)
01-1122-0010	Various	7,500 (3,402)	92 (234)	28 (13)
01-1170-0010	Cessna Caravan	10,000 (4,536)	109 (227)	42 (19)
01-1222-0000	Piaggio P-180	1,100 (499)	104 (264)	44 (20)
01-1233-0010	Aerospatale TMB-700 (requires adaptor kit K-2200) Cessna 150, 152, 172, 177, 180, 182, 185, 206, 207, 210 (180, 185 requires adaptor kit K-2041) Piper Aztec, Cherokee, Comanche, Seneca Raytheon Baron, Duke Universal Towbar	7,500 (3,402)	95 (241)	35 (16)
01-1273-0010	Raytheon JPATS T-6A Texan II	6,500 (2,948)	96 (244)	35 (16)
01-1283-0000	Raytheon JPATS T-6A Texan II (with pneumatic tires)	6,500 (2,948)	96 (244)	51 (23)
01-1298-0000	Eclipse 500	7,500 (3,402)	86 (218)	25 (11)
01-1313-0000	Diamond DA20, DA40	1,764 (800)	75 7/8 (192)	22 (10)
01-1366-0010	Cessna Citation Encore	17,100 (7,756)	80.5 (204)	38 (17)

Portable Snap-Bak Towbars

Standard Features:

- Features are the same as above, but towbar may be collapsed for portability



Specifications:

Model Number	Manufacturer/Aircraft	Capacity lb (kg)	Extended Length in (cm)	Closed Length in (cm)	Weight lb (kg)
01-1179-0010	Raytheon Beechjet, Diamond	16,000 (7,258)	59 (150)	83 (211)	38 (17)
01-1286-0000	Raytheon Premier	12,500 (5,670)	68 (173)	110 (279)	40 (18)

Closed - is the overall length of the unit when closed

Extended - is the length from the center of the towing eye to the center of the sliding pins

Towbar Accessories

Multi-Head Storage Rack

Standard Features:

- Mobile, strong and durable
- Stores 500, 600 and 800 Series multi heads
- Swivel casters with 2 lockable wheels
- Stainless steel construction and hardware
- Low profile to fit under most aircraft wings
- Keeps hangar floor space organized
- Easy assembly, attach additional racks together as needed
- Finish: Low reflective stainless steel



Specifications:

Model Number	Head Capacity	Length in (cm)	Width in (cm)	Height in (cm)	Weight lb (kg)
01-1954-6000	6	36.5 (92.7)	16 (40.6)	14 (35.6)	34 (15.4)
01-1954-6002	12	73 (185.4)	16 (40.6)	14 (35.6)	68 (30.8)

Telecoupler

Standard Features:

- Minimizes eyebolt binding
- Finish: Yellow polyurethane



Specifications:

Model Number	Capacity lb (kg)	Closed in (cm)	Extended in (cm)	Weight lb (kg)
01-1950-5000	100,000 (45,359)	18 (46)	23 (58)	60 (27)

Shear and Shock Protection

Shear Protection:

Where required by the aircraft manufacturer, Tronair incorporates shear protection in different forms:

- Tension/Compression Shear protects from excessive "pull" or "push" loads to nose gear.
- Radial Shear protects nose gear from excessive loads while turning. Attachment heads are made to break a shear pin if a safe turning load is exceeded; but head stays secured to towbar.
- Dual Shear attachment heads are made to break a shear pin if maximum turning load or straight overload limits are exceeded; but head stays secured to towbar.

Some towheads will incorporate one of the above shear formats, while others will incorporate tension/compression and/or radial shear protection.

Shock Absorber Protection:

- All multi-head towbars incorporate a spring type shock absorber that helps protect the nose gear from shock loads encountered during normal towbar operation.

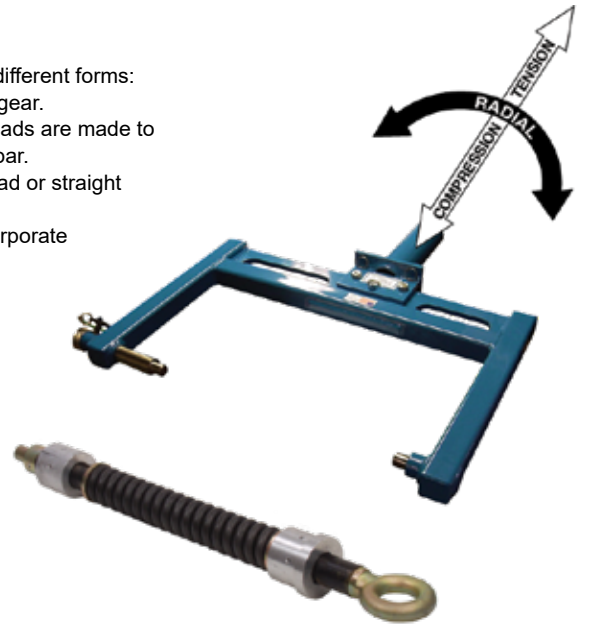

Standard Features:

Models: 99-9045-9000

- Meets TSA regulation 49 CFR Part 1544
- Provides theft deterrence for aircraft
- Strong rugged steel design
- Shackleless steel lock with 3 keys (multiple units are keyed alike for fleet protection)
- Secure your aircraft quickly and easily
- Fits virtually all business and regional aircraft
- Finish: Painted Bright Red



Specifications:

Model Number	Length in (cm)	Width in (cm)	Height in (cm)	Weight lb (kg)
99-9045-9000	32 (81)	11 (24.4)	9 (22.9)	25.2 (11.43)

Wheel Chocks



Specifications:

Model Number	Color	Length in (cm)	Width in (cm)	Height in (cm)	Weight lb (kg)
99-9008-6000	Black	4 (10)	18 (46)	3 (8)	7 (3)
99-9010-6000	Black	8 (20)	9 (23)	6 (15)	19 (9)
99-9015-6000	Black	5 (13)	18 (46)	5 (13)	16 (7)
99-9016-6000	Yellow	5 (13)	18 (46)	5 (13)	16 (7)
99-9016-6030	Yellow	5 (13)	30 (76)	5 (13)	29 (13)
99-9028-6000	Black with Orange Stripe	6 (15)	12 (31)	6 (15)	20 (9)
99-9028-6024	Black with Orange Stripe	6 (15)	24 (61)	6 (15)	40 (18)
99-9028-6036	Black with Orange Stripe	6 (15)	36 (91)	6 (15)	60 (27)
99-9028-6048	Black with Orange Stripe	6 (15)	48 (122)	6 (15)	80 (36)
99-9029-6000	Yellow with Orange Stripe	6 (15)	12 (31)	6 (15)	20 (9)

Covers

99-8133-6000



Specifications:

Model Number	Manufacturer/Aircraft	Cover Application	Length in (cm)	Width in (cm)	Height in (cm)	Weight lb (kg)
99-7099-6000	Gulfstream G280	APU Exhaust	12 (30.48)	6 (15.24)	4.25 (10.8)	7.5 (3.4)
99-7100-6000	Gulfstream G280	Vertical Fin Ram Air Scoop	4.3 (10.9)	7.5 (19)	11 (27.94)	6 (2.7)
99-7101-6000	Gulfstream G280	EDS Heat Exchange	5.3 (13.5)	5.5 (13.97)	1.75 (4.4)	1.3 (.29)
99-7102-6000	Gulfstream G280	Wing NACA Scoop	7 (17.78)	4.5 (11.43)	2.19 (5.6)	1 (.45)
99-7108-6000	Gulfstream G280	Wing NACA Scoop	6.13 (15.6)	4.5 (11.43)	2.19 (5.6)	.8 (.36)
99-7103-6000	Gulfstream G280	Ice Detector AOA TAT	4.3 (10.9)	8.5 (21.59)	9.9 (25.1)	1 (.45)
99-7107-6000	Gulfstream G280	Static (Left & Right)	1.4 (3.6)	14.9 (37.8)	16 (40.6)	1 (.45)
99-7110-6000	Gulfstream G280	Outflow Valve	1.6 (4.1)	10.75 (27.3)	10.5 (26.7)	1.3 (.59)
99-7111-6000	Gulfstream G280	Air Cycle Machine Outlet	1.75 (4.4)	7.9 (20.1)	8.75 (22.2)	1 (.45)
99-8133-6000	Bombardier deHavilland Dash 8	Engine Intake	25 (63.5)	10.5 (26.7)	4.25 (10.8)	4.5 (2)

Hydraulic & Engine Oil Servicing Equipment

Standard Features:

Models: 06-5009C6500, 06-5009C6600, 06-5009C6800
06-5010-6500, 06-5010-6600, 06-5010-6800
06-5077-6700

- ASME certified stainless steel reservoir
- 06-5009-Series: 2.5 gal (9.5 l)
- 06-5010-Series: 6 gal (28 l)
- 2 micron filtration (Beta rating > 1000 @ 4 µm per ISO 4572)
- 100 psi (6.9 bar) certified pressure gauge
- 85 psi (5.9 bar) maximum pressure
- 125 psi (8.6 bar) safety pop off valve
- 15 ft (4.6 m) #4 hose with 37° JIC female swivel connector, shut off valve and filler tube
- 8 in (20 cm) semi-pneumatic tires - Model 06-5010 only

06-5010-Series

06-5009-Series



Standard Features:

Models: 06-5020-1500, 06-5020-1800, 06-5020-3600
06-5043-1500, 06-5043-1800, 06-5043-3600
06-5084-1500

- Sturdy welded steel construction
- 16 gauge sheet metal weather proof cabinet
- 06-5043 Series: 15 gal (56.8 l) corrosion resistant reservoir
- 06-5084-1500: 15 gal (56.8 l) stainless steel reservoir
- 06-5020 Series: Holds two 5 gallon buckets
- 2 micron filtration (Beta rating > 2000 per ISO 4572)
- 150 psi (10.3 bar) maximum pressure
- High displacement hand pump (13 strokes per quart)
- 15 ft (4.6 m) #6 hose with 37° JIC female swivel connector
- Front wheels lock with towbar in upright position
- 10 in (25 cm) pneumatic tires
- Finish: Durable Powder Coat Tronair Blue

06-5043-Series



Standard Features:

Models: 06-5021-1500, 06-5021-1800, 06-5021-3600

- Pump directly from 5 gallon container
- 2 micron filtration (Beta rating > 2000 per ISO 4572)
- 200 psi (13.8 bar) maximum pressure
- High displacement hand pump (13 strokes per quart)
- 15 ft (4.6 m) #6 hose with 37° JIC female swivel connector
- 06T5021-1500 and 06T5021-3600 adds a Totalizer to unit
- Finish: Durable Powder Coat Tronair Blue

06-5021-Series



Standard Features:

Models: 06-5022-6500, 06-5022-6600, 06-5022-6800

- Stainless steel construction
- 2 gal (7.6 l) reservoir
- 2 micron filtration (Beta rating > 1000 @ 4 µm per ISO 4572)
- 200 psi (13.8 bar) maximum pressure
- 2 in (5 cm) filler port
- High displacement hand pump (13 strokes per quart)
- 15 ft (4.6 m) #6 hose with 37° JIC female swivel connector
- Hose storage bracket

06-5022-Series



Standard Features:

Model: 06-5082-6700

- Stainless steel construction
- 2 gal (7.6 l) reservoir
- Sealed fill cap with pressure relief and vacuum breaker valves
- 2 micron filtration (Beta rating > 1000 @ 4 µm per ISO 4572)
- 200 psi (13.8 bar) maximum pressure
- 2 in (5 cm) filler port
- High displacement hand pump (13 strokes per quart)
- Bulkhead plate for installation of size #12 bulkhead quick disconnect coupling half (coupling not included)
- 8 in (20.3 cm) sight glass
- Hose storage bracket

06-5082-6700



Standard Features:

Models: 06-5024-3510, 06-5024-3610, 06-5024-3800
06T5024-3510, 06T5024-3610, 06T5024-3800

- Sturdy welded steel construction
- Attaches to any 55 U.S. gallon drum
- 2 micron filtration (Beta rating > 2000 per ISO 4572)
- 100 psi (6.9 bar) maximum pressure
- 14 gpm maximum flow
- 15 ft (4.6 m) #6 hose with 37° JIC female swivel connector
- Shut off valve at hose end
- Operates off shop air
- Optional drum dolly (H-1726)
- 06T5024-3510, 06T5024-3610, 06T5024-3800 adds a Totalizer to unit
- Finish: Durable Powder Coat Tronair Blue

06-5024-Series
(shown mounted)



Standard Features:

Models: 06-5025-1512, 06-5025-3610

- 68 gal (257 l) capacity
- 100 psi (6.9 bar) maximum pressure
- 14 gpm maximum flow
- 2 micron filtration (Beta rating > 2000 per ISO 4572)
- High displacement pneumatic pump driven by self-contained nitrogen bottle
- 15 ft (4.6 m) #6 hose with 37° JIC female swivel connector and shut-off valve
- Front wheels lock with towbar in upright position
- Finish: Durable Powder Coat Tronair Blue

06-5025-Series



Standard Features:

Models: 06-5042-0500, 06-5042-0800, 06-5042-3600

- Sturdy welded steel construction
- 8 gal (30.1 l) fluid resistant reservoir
- 2 micron filtration (Beta rating > 2000 per ISO 4572)
- 200 psi (13.8 bar) maximum pressure
- High displacement hand pump (13 strokes per quart)
- 15 ft (4.6 m) #6 hose with 37° JIC female swivel connector
- 8 in (20 cm) semi-pneumatic tires
- Finish: Durable Powder Coat Tronair Blue

06-5042-Series



Standard Features:

Model: 06-5080-0500, 06-5080-0600

- Skydrol Recovery Cart to store clean fluid
- Sturdy welded steel construction
- 150 gal (567.8 l) stainless steel reservoir
- 2 micron air desiccant filtration
- Fluid level sightgauge
- Drain valve and cap
- Towing handle for ease of movement
- Forklift tubes

06-5080-0600



Specifications: See Hydraulic Couplings on pages 131 - 135

Model Number by Fluid Type			Length in (cm)	Width in (cm)	Height in (cm)	Weight lb (kg)
MIL-PRF-5606 MIL-PRF-83282	Phosphate Ester	MIL-PRF-23699 MIL-PRF-87257				
06-5009C6500	06-5009C6600	06-5009C6800	10 (25)	10 (25)	17 (43)	15 (6.8)
06-5010-6500	06-5010-6600	06-5010-6800	17 (43)	14 (36)	44 (112)	44 (20)
06-5020-1500	06-5020-3600	06-5020-1800	35.25 (89.5)	28.5 (72)	38.375 (97)	250 (113)
06-5021-1500	06-5021-3600	06-5021-1800	19.125 (49)	21 (53)	45.5 (116)	45 (20)
06T5021-1500	06T5021-3600	NA	19.125 (49)	21 (53)	45.5 (116)	45 (20)
06-5022-6500	06-5022-6600	06-5022-6800	8 (21)	8 (21)	20 (52)	18 (8)
06-5024-3510	06-5024-3610	06-5024-3800	28 (71)	9 (23)	15 (38)	29 (13)
06T5024-3510	06T5024-3610	06T5024-3800	28 (71)	12 (29)	15 (38)	29 (13)
06-5025-1512	06-5025-3610	NA	73 (185)	50 (127)	52.5 (133)	390 (177)
06-5042-0500	06-5042-3600	06-5042-0800	23 (58)	19 (48)	35 (89)	60 (27)
06-5043-1500	06-5043-3600	06-5043-1800	45 (114)	29 (73.7)	35 (89)	250 (113)
06-5080-0500	06-5080-0600	NA	62.5 (158.75)	34.5 (87.6)	38.6 (98)	508 (230.4)
NA	NA	06-5082-6700	14.75 (37.5)	10 (25)	21 (53)	18 (8)
Fluid Type - Touline		06-5009C6800	10 (25)	10 (25)	17 (43)	15 (6.8)

SHIMMY DAMPER FLUID SERVICE UNIT

Standard Features:

Model: 06-5022-6C00 (Embraer)

- Fluid servicing of shimmy damper unit on aircraft
- Designed for high viscosity silicone damper fluid
- Designed in conjunction with the airframe manufacture(s)
- Schraider valve output connector
- Stainless steel construction
- Maximum output pressure 200 psi (13.8 bar)
- Stroke Displacement 4.4 in/stroke (72.1 cc/stroke)
- 2 gal (7.6 l) reservoir
- 2 micron filtration
- 2 in (5 cm) filler port
- Hose storage bracket



06-5022-6C00

Model: 06-5056-1D00 (Sikorsky)

- Fluid servicing of shimmy damper unit on aircraft
- Designed for high viscosity silicone damper fluid
- Designed in conjunction with the airframe manufacture(s)
- Schraider valve output connector
- Stainless steel construction
- Maximum output pressure 125 psi (8.6 bar)
- Stroke Displacement 14.7 in/stroke (240.9 cc/stroke)
- Compressed air driven

06-5056-1D00



CSD SERVICE CART

Standard Features:

Model: 06-5073-0800

- MIL-PRF-23699 Fluid
- 4 gal (15 l) reservoir
- 5 gal (18.9 l) detachable waste tank
- Inline totalizer with pint graduations
- 2 micron filtration (Beta rating > 2000 per ISO 4572)
- 200 psi (13.8 bar) maximum pressure
- High displacement hand pump (13 strokes per quart)
- Supply and return couplings with stow points
- 7 ft (2 m) supply hose
- Finish: Durable Powder Coat Tronair Blue



06-5073-0800

Specifications:

Model Number	Length in (cm)	Width in (cm)	Height in (cm)	Weight lb (kg)
06-5022-6C00	8 (21)	8 (21)	20 (52)	18 (8)
06-5056-1D00	12 (30.5)	12 (30.5)	12 (30.5)	9.5 (4.3)
06-5073-0800	20 1/8 (51)	21 (53)	45 1/2 (116)	50 (22.7)

IN-LINE FILTER KITS

Standard Features:

- Anodized aluminum housing
- #6 SAE female ports
- EPR or Vitron seals
- 2 micron absolute rating per ISO 4572
- Beta rating > 1000 at 4 micron
- Dirt capacity of 1.38 grams at < 50 psig
- 150 psi (10 bar) collapse rating
- 3,000 psi (207 bar) maximum pressure rating
- Dimensions:
 - Length: 4.75 in (12 cm)
 - Diameter: 1.5 in (3.8 cm)
 - Dry Weight: 1 lb (.5 kg)



HC-2140/HC-2141

Specifications:

	Fluid Type	
	MIL-PRF-5606, MIL-PRF-83282 MIL-PRF-23699, MIL-PRF-87257	Skydrol, Hyjet
Kit Type	Kit Number	Kit Number
In-Line Conversion	K-3677 Fits: 06-5009C6500, 06-5010-6500	K-3676 Fits: 06-5009C6600, 06-5010-6600
	K-3678 Fits: 06-4005-0511	K-3679 Fits: 06-4005-3611
	K-3680 Fits: 06-5022-6500	K-3681 Fits: 06-5022-6600
Replacement Element	K-3659	K-3658
Filter Assembly	HC-2141	HC-2140

RESERVOIR SERVICE

06-5022-6500-A7



Standard Features:

- Model: 06-5022-6500-A7
- NSN: 4940-01-504-5279
- Military Approved
- Stainless steel construction
- 2 gal (7.6 l) reservoir
- Sealed fill cap with pressure relief and vacuum breaker valves
- 2 micron filtration (Beta rating > 1000 @ 4 µm per ISO 4572)
- 200 psi (13.8 bar) maximum pressure
- 2 in (5 cm) filler port
- High displacement hand pump (13 strokes per quart)
- 15 ft (4.6 m) #6 hose with 37° JIC female swivel connector
- Bulkhead plate for installation of size #12 bulkhead quick disconnect coupling half (coupling not included)
- Adaptor fittings for connecting size #12, MS33656 and MS33657 quick disconnect couplings
- 8 in (20.3 cm) sight glass
- Hose storage bracket

Quick Disconnect Couplings:

Helicopter	Coupling	Model	NSN
*AH-64, UH-60	Coupling Half	N-2417-06	4730-00-540-1268
*AH-64, UH-60	Bulkhead Half	N-2705-06	4730-00-541-1115
*CH-47	Coupling Half	N-2424-06	4730-00-585-0469
*CH-47	Bulkhead Half	N-2559-05	4730-00-729-5736

* Note: Must purchase both a Coupling Half and Bulkhead Half. The Coupling Half attaches to hose and allows connection to either the helicopter or to the Bulkhead Half

PAO SERVICE

Standard Features:

- Models: 06-5022-6500-A6
- Stainless steel construction
- 2 gal (7.6 l) reservoir
- 2 micron filtration (Beta rating > 1000 @ 4 µm per ISO 4572)
- 200 psi (13.8 bar) maximum pressure
- 2 in (5 cm) filler port
- High displacement hand pump (13 strokes per quart)
- 15 ft (4.6 m) #6 hose with 37° JIC female swivel connector
- Hose storage bracket

06-5022-6500-A6



Standard Features:

- Models: 06-5038-9B00, 06-5067-9B00
- 68 gal (257 l) capacity
- 100 psi (6.9 bar) maximum pressure
- 14 gpm maximum flow
- 2 micron filtration (Beta rating > 2000 per ISO 4572)
- High displacement pneumatic pump driven by self-contained nitrogen bottle
- 15 ft (4.6 m) #6 hose with 37° JIC female swivel connector and shut-off valve
- Front wheels lock with towbar in upright position
- Finish: Durable Powder Coat Olive Drab



06-5067-9B00

Specifications:

Model Number	Fluid	Length in (cm)	Width in (cm)	Height in (cm)	Weight lb (kg)
06-5022-6500-A7	MIL-PRF-5606/MIL-PRF-83282	14.375 (36.5)	10 (26)	21 (53)	18 (8)
06-5022-6500-A6	MIL-C-87252	8 (21)	8 (21)	20 (52)	18 (8)
06-5038-9B00	MIL-C-87252	73 (185)	50 (127)	52 1/2 (133)	390 (177)
06-5067-9B00	MIL-C-87252	73 (185)	50 (127)	52 1/2 (133)	390 (177)

Hydraulic & Engine Oil Test Equipment

Standard Features:

Models: 06-4005-0511, 06-4005-0800, 06-4005-3611

- 2 qt (1.9 l) reservoir
- 2 micron filtration (Beta rating > 1000 @ 4 µm per ISO 4572)
- Shut off valve (zero leakage)
- Single stage manual hand pump
- Stroke displacement .58 in³/stroke
- Relief set 3,250 psi
- Pressure gauge 5,000 psi (345 bar)
- 15 ft (4.6 m) #4 hose with 37° JIC female swivel connector
- Finish: Durable Powder Coat Tronair Blue



06-4005-Series

Specifications:

Model Number by Fluid Type			Length in (cm)	Width in (cm)	Height in (cm)	Weight lb (kg)
MIL-PRF-5606 MIL-PRF-83282	Phosphate Ester	MIL-PRF-23699 MIL-PRF-87257				
06-4005-0511	06-4005-3611	06-4005-0800	19 (48)	6 (15)	19 (48)	25 (11)

Standard Features:

NSN: 4920-01-578-3125 - for model 06-4035-0500

Models: 06-4035-0500, 06-4035-0800, 06-4035-3600
 06-5004-0800, 06-5004C0500, 06-5004C3600 - CE Marked
 06-5040-0510 , 06-5040-0800, 06-5040-3600
 06-5041-0500, 06-5041-0800, 06-5041-3610
 06-5074-0500, 06-5074-0800

- 8 gal (30 l) polyethylene reservoir
- 15 ft (4.6 m) #4 hose with 37° JIC female swivel connector
- Shut off valve for static testing
- 2 micron filtration (Beta rating > 2000 per ISO 4572)
- Dual stage manual hand pump
- Stroke displacement : 2.1 in³/stroke to 500 psi, .4 in³/stroke to 5,000 psi
- 8 in (20 cm) semi-pneumatic tires
- Dual hose selector valve standard on 06-5004 and 06-5041 series only
- Sturdy welded steel construction
- Dimensions
 Length: 19 in (48 cm)
 Width: 19 in (48 cm)
 Height: 32 in (81 cm)
- Finish: Durable Powder Coat Tronair Blue



06-4035-Series

06-5004-Series

Specifications:

Model Number by Fluid Type			Max Working Pressure psi (bar)	Pressure Gauge psi (bar)	Weight lb (kg)
MIL-PRF-5606 MIL-PRF-83282	Phosphate Ester	MIL-PRF-23699 MIL-PRF-87257			
06-4035-0500	06-4035-3600	06-4035-0800	3,000 (207)	5,000 (345)	65 (29.5)
06-5004C0500	06-5004C3600	06-5004-0800	3,000 (207)	5,000 (345)	65 (29.5)
06-5040-0510	06-5040-3600	06-5040-0800	5,000 (345)	6,000 (414)	65 (29.5)
06-5041-0500	06-5041-3610	06-5041-0800	5,000 (345)	6,000 (414)	65 (29.5)
06-5074-0500	06-5074-0600	06-5074-0800	5,000 (345)	6,000 (414)	65 (29.5)

Standard Features:

All Models:

- Dump and fill tanks constructed of high density polyethylene with UV inhibitors
- Supply pump operates @ 20 psi max
- Front wheels lock with towbar in upright position (OSHA Act 1970 Section 5(a)(1) - General Duty Clause - an employer has the general duty to provide a safe work environment free from known hazards. Potential movement of the cart on an uneven surface or incline is eliminated by the locking front wheels)
- Front wheel assembly for easy maneuvering
- Finish: Durable Powder Coat Tronair Blue



Additional Features:

Models: 10-4036-0001, 10-4036-0010, 10D4036-0010, 10-6408-0000

- Sturdy welded steel construction
- 2 in (5 cm) x 10 ft (3.1 m) discharge hose with end cap
- 1 in (2.54 cm) x 8 ft (2.4 m) fill hose
- Manual fill and dump pumps (6 stroke per gallon)
- 10-6408-0000 manual dump and electric fill pump (5 gpm)
- 8 in (20 cm) pneumatic tires
- Order 10D4036-0010 for Shorts Aircraft (includes K-1036)
- Note: 10-4036-0001 includes K-2029 & K-2410 connectors
- Note: Dump and fill connectors not included

Model: 10-6409-0000

- Gravity emptied dump tank with gate valve
- 6 ft (1.8 m) blue waste hose with GA coupler
- 10 ft (3 m) black waste outlet hose
- 12 ft (3.7 m) clear fill hose with coupler and plug
- Manual fill pump (4 stroke per gallon)
- Extra wide access port to sloped waste tank makes for easy cleaning
- 10 in (25.4 cm) pneumatic tires
- Heavy duty chassis and towing system



Specifications:

Model Number	Fill Pump	Dump Tank gal (l)	Fill Tank gal (l)	Length in (cm)	Width in (cm)	Height in (cm)	Weight lb (kg)
10-4036-0001	Manual	31 (117)	15 (57)	54 (137)	36 (91)	22 (56)	280 (127)
10-4036-0010	Manual	31 (117)	15 (57)	54 (137)	36 (91)	22 (56)	280 (127)
10D4036-0010	Manual	31 (117)	15 (57)	54 (137)	36 (91)	22 (56)	280 (127)
10-6408-0000 *	Electric	31 (117)	15 (57)	54 (137)	36 (91)	22 (56)	280 (127)
10-6409-0000	Manual	30 (114)	25 (95)	64 ¼ (165.7)	39 ¼ (99.7)	27 ¼ (69.2)	194 (88)

*50 Hz requires adaptor to be purchased locally

Lavatory Servicing Carts

Standard Features:

All Models:

- Dump and fill tanks constructed of high density polyethylene with UV inhibitors
- Supply pump operates @ 20 psi max
- Sturdy welded steel construction
- Gravity emptied dump tank with gate valve
- 18 in (46 cm) discharge hose
- 1 in (2.54 cm) x 8 ft (2.4 m) fill hose
- Drain back valve empties fill hose after use
- Front wheels lock with towbar in upright position (OSHA Act 1970 Section 5(a) (1) - General Duty Clause - an employer has the general duty to provide a safe work environment free from known hazards. Potential movement of the cart on an uneven surface or incline is eliminated by the locking front wheels)
- Front wheel assembly for easy maneuvering
- Finish: Durable Powder Coat Tronair Blue

Note: Dump and fill connectors not included



Additional Features:

Model: 10-6401-0010, 10-6411-0000

- Manual fill and dump pumps (6 stroke per gallon)
- 10-6411-0000 manual dump and electric fill pump (5 gpm)
- 8 in (20 cm) wheels

Models: 10-6402-0010, 10-6412-0000

- 30 in (76 cm) height to dump hose connection
- Manual fill pump with totalizer (10-6402-0010)
- 8 in (20 cm) front wheels
- 10 in (25 cm) rear wheels

Specifications:

Model Number	Fill Pump	Dump Tank gal (l)	Fill Tank gal (l)	Length in (cm)	Width in (cm)	Height in (cm)	Weight lb (kg)
10-6401-0010	Manual	136 (515)	68 (257)	81 (206)	46 (117)	51 (130)	700 (318)
10-6402-0010	Manual	68 (257)	31 (117)	64 (163)	37.5 (95)	49.5 (126)	600 (272)
*10-6411-0000	Electric	136 (515)	68 (257)	81 (206)	46 (117)	51 (130)	700 (318)
10-6412-0000	Electric	68 (257)	31 (117)	64 (163)	37.5 (95)	49.5 (126)	600 (272)

*50 Hz requires adaptor to be purchased locally

Fittings, Connectors, Adaptors & Tools



Kit Number	Part Type	Description
H-1770	Aircraft Lavatory Plug	4 in (10.2 cm) standard replacement lavatory plug
K-3606	Dump Coupling Plug	Used to prevent spilling waste solution
K-4712	HondaJet Adaptor	Fill connector
K-2288	Learjet 60 Adaptor	Adapts 2 in (5.1 cm) aircraft dump system to standard 4 in (10.2 cm) standard coupling Includes Lear 60 Fill Adaptor
K-1036	Shorts 330/360 Adaptor	3 in (7.6 cm) aircraft system with fill connector
K-2410	Chemical Fill Connector	Used to fill lavatory chemical solution reservoir
K-2412	Straight Type Dump Connector	Dump coupling with 5 ft (1.52 m), 4 in (10.2 cm) I.D. hose
H-1769	Wye Type Dump Connector	Used as an extension with straight connector kit K-2412
K-2029	Wye Type Dump Connector	Dump coupling with 5 ft (1.52 m), 4 in (10.2 cm) I.D. hose
K-2029-A1	Wye Type Dump Connector	Dump coupling with 10 ft (3.05 m), 4 in (10.2 cm) I.D. hose
K-2922	Wye Type Dump Connector	Dump coupling with 15 ft (4.6 m), 4 in (10.2 cm) I.D. hose

Standard Features:

- Operates by 12 VDC electric battery with built in charger
- 4.5 gpm (17 lpm) electric pump
- Available in 50 and 60 Hz
- Meets recognized health organization standards
- Cold weather carts are protected with insulated sheet metal and a 110 volt mat heater
- High density polyethylene tank with UV inhibitor
- Tank access opening for cleaning or bottle water filling
- 15 ft (4.6 m) output hose with potable water coupling
- Front wheels lock with towbar in upright position
- Sturdy welded steel construction
- Finish: Durable Powder Coat Tronair Blue



Kit Number	Part Type	Description
H-2217	Open Hose Fill Coupling & Plug	Plug prevents contamination when locked into coupling during non-use
K-2411	Potable Water Fill Connector	Used to fill aircraft potable water reservoir

Specifications:

Model Number	Heater	Capacity gal (l)	Frequency Hz	Tires in (cm)	Length in (cm)	Width in (cm)	Height (towbar up) in (cm)	Empty Weight lb (kg)
19-4301-0000	No	100 (379)	50/60	12 (31)	74 (188)	40 (102)	42 (107)	500 (227)
19-4303-0000	Yes	100 (379)	60	12 (31)	74 (188)	40 (102)	42 (107)	500 (227)
19-4305-0000	No	31 (117)	50/60	10 (25)	66 (168)	25 (64)	29 (74)	274 (124)
19-4306-0000	Yes	31 (117)	60	10 (25)	66 (168)	25 (64)	30 (76)	274 (124)
19-4311-0000	Yes	100 (379)	50	12 (31)	74 (188)	40 (102)	42 (107)	500 (227)
19-4310-0000	Yes	31 (117)	50	10 (25)	66 (168)	25 (64)	30 (76)	274 (124)

Nitrogen and Oxygen Transport Carts



12-3103-6011

12-3100-1000

PC-1107

12-3104-0000

20-4521-9000

One and Two Bottle

Standard Features:

- Sturdy welded steel construction
- Holds 9 in (23 cm) 3,500 psi (241.3 bar) high pressure bottles
- Chain provided to secure bottles to cart
- Tilt-back positioning to stabilize load (12-3103-6011 only)
- Soft rubber tires prevent damage to floors
- Finish: Durable Powder Coat Tronair Blue

Accessories:

- PC-1107 - 300 cu ft certified nitrogen bottle (empty)
- PC-1124 - 200 cu ft certified oxygen bottle (empty)

See page 146 for additional service gauges

One and Four Bottle

Standard Features:

- Sturdy welded steel construction
- 13 in (33 cm) pneumatic tires
- Fits bottle lengths from 48 to 64 in (122 to 163 cm) to hold bottles securely in place (back stop on 12-3104-0000 is adjustable)
- 20-4521-9000 comes with oxygen cleaned regulator
- Front wheels lock with towbar in upright position
- Towbar with 2³/₁₆ in (5.6 cm) ID eyebolt
- Hose storage compartment
- Maximum towing speed 10 mph (16 km)
- Reflectors for night visibility
- Finish:
 - Durable Powder Coat Tronair Blue
 - Durable Powder Coat Green - 12-3104-0000SP
 - Durable Powder Coat Orange - 20-4521-9000

Specifications:

Model Number	Bottle Capacity	Tiltable	Length in (cm)	Width in (cm)	Height in (cm)	Weight lb (kg)
12-3100-1000	2	No	NA	30 (76)	43 (109)	45 (20)
12-3103-6011	1	No	NA	20 (51)	44 (112)	30 (14)
12-3104-0000	4	No	80 (203)	31 (79)	37 (94)	230 (104)
18-4317-0000	1	Yes	80.7 (205)	28.5 (72)	46.75 (119)	170 (77)
20-4521-9000	1	Yes	80.7 (205)	28.5 (72)	46.75 (119)	170 (77)

International Gas Cylinder Connector Chart: one fitting and one check valve per bottle is required

Country	Nitrogen Part Number	Oxygen Part Number	Country	Nitrogen Part Number	Oxygen Part Number
Argentina	PC-1174	PC-1184	Netherlands	PC-1164	PC-1179
Australia	PC-1172	PC-1183	Norway	PC-1162	---
Austria	PC-1162	PC-1178	Poland	PC-1162	PC-1178
Belgium	PC-1164	PC-1179	Qatar	PC-1160	PC-1177
Brazil	PC-1176	PC-1185	Slovakia	PC-1162	---
Czech Republic	PC-1162	---	Spain	PC-1170	PC-1182
Denmark	PC-1162	---	Sweden	PC-1162	---
Finland	PC-1162	---	Switzerland	PC-1162	PC-1178
France	PC-1166	PC-1180	UAE	PC-1160	PC-1177
Germany	PC-1162	PC-1178	UK	PC-1160	PC-1177
Italy	PC-1168	PC-1181			

Nitrogen Check Valve: PC-1151

Oxygen Check Valve: PC-1152

ATTENTION non-North American customers Tronair supplies a standard CGA cylinder connector that will ONLY connect to a North American gas cylinder. Non-North American customers can purchase specific fittings from the International Gas Cylinder Connector Chart or must provide their local gas cylinder connection to ensure proper fit.

ATTENTION non-North American customers Tronair supplies a standard CGA cylinder connector that will ONLY connect to a North American gas cylinder. Non-North American customers can purchase specific fittings, see the International Gas Cylinder Connector Chart, or must provide their local gas cylinder connection to ensure proper fit.

Standard Features:

- 4 hose manifold to connect bottles with CGA-580 fittings
- High pressure regulator 25 to 4,000 psi (1.7 to 276 bar) certified gauge with 15 ft (4.6 m) #4 output hose (not applicable for 18-4314-9800)
- Low pressure regulator 0 to 500 psi (.2 to 34.5 bar) certified gauge with 15 ft (4.6 m) #4 output hose
- Temperature range 0° to 200° F (17.7° to 93.3° C)
- Operating instructions located on instrument panel
- Sturdy welded steel construction
- Holds four 9 inch (23 cm) diameter nitrogen bottles (bottles not included)
- 13 in (33 cm) diameter pneumatic tires
- Front wheels lock with towbar in upright position (OSHA Act 1970 Section 5(a)(1) - General Duty Clause - an employer has the general duty to provide a safe work environment free from known hazards. Potential movement of the cart on an uneven surface or incline is eliminated by the locking front wheels)
- Movable back stop adjusts to fit bottle lengths from 48 to 64 in (122 to 163 cm) to hold bottles securely in place
- Towbar with 2³/₁₆ in (5.6 cm) ID eyebolt
- Maximum towing speed 10 mph (16 km/hr)
- Hose storage compartment
- Reflectors to improve night visibility
- Low Profile
- Finish:
Durable Powder Coat Tronair Blue
Durable Powder Coat Orange - 18-4313-9000
Custom Colors Available



With Booster Includes Standard Features:

- CE Marked
- 4,000 psi (276 bar) nitrogen intensifier (booster) operates off low pressure regulator
- Intensifier (booster) automatically shuts down when aircraft reaches set pressure

Additional Standard Features:

18-4313-9000:

- CGA-350 connectors
- 2 additional 10 ft (3 m) hoses

18-4314-9800:

- Nitrogen blow out system regulates the pressure to the aircraft and checks the hydraulic system for leaks prior to filling with hydraulic fluid
- Low pressure regulator output to hydraulic system 0 to 150 psi (0 to 10.3 bar) with 15 ft (4.6 m) service hose

18-4315-0000, 18-4316-0000:

- Easy, one person loading and unloading of cylinders, no muscle strains from picking up cylinders (OSHA Act 1970 Section 5(a)(1) - General Duty Clause and EU OSHA Directive 90/269/EEC - Manual Handling of Loads)
- Extremely easy rotation to horizontal in use position OSHA Act 1970 Section 5(a)(1) - General Duty Clause and EU OSHA Directive 90/269/EEC - Manual Handling of Loads)
- Extra secure locking pivot point
- Easy and affordable conversion from existing Tronair cart

Accessories:

- PC-1151 - In-line check (Required if CGA-580 fittings are replaced)
- 18-4316-0000 - Conversion cart, no booster
- PC-1107 - 300 cu ft certified bottle (empty) Color - gray
- K-4824 - Converts 18-4208-0010 to run off nitrogen bottles or shop air

See page 146 for additional service gauges
See page 145 for adaptors



Specifications:

Model Number	Gas	Booster	Tiltable	Length in (cm)	Width in (cm)	Height in (cm)	Weight lb (kg)
18-4208-0010	Nitrogen	Yes	No	80 (203)	30.5 (77.5)	37 (94)	360 (163)
18-4303-0000	Nitrogen	No	No	80 (203)	30.5 (77.5)	37 (94)	360 (163)
18-4306-0000	Helium	Yes	No	80 (203)	30.5 (77.5)	37 (94)	360 (163)
18-4313-9000	Nitrogen	Yes	No	80 (203)	30.5 (77.5)	37 (94)	360 (163)
18-4314-9800	Nitrogen	Yes	No	81 (206.7)	38.5 (97.8)	47 (118.6)	370 (169)
18-4315-0000	Nitrogen	Yes	Yes	92.8 (235.7)	35.8 (91)	46.7 (118.6)	564 (256)
18-4318-0000	Nitrogen	No	Yes	92.8 (235.7)	35.8 (91)	46.7 (118.6)	450 (204)

Nitrogen Boosters

ATTENTION non-North American customers Tronair supplies a standard CGA cylinder connector that will ONLY connect to a North American gas cylinder. Non-North American customers can purchase specific fittings, see the International Gas Cylinder Connector Chart, or must provide their local gas cylinder connection to ensure proper fit.

Standard Features:

Model: 18-4200-1100 Semi-Manual

- Mounts on standard nitrogen bottles with CGA-580 connector
- 10 cfm (4.7 lps) at 90 psi (6.2 bar) shop air required
- Sturdy welded steel construction
- 15 ft (4.6 m) #4 output hose with 37° JIC female swivel connector
- 5,000 psi (345 bar) certified pressure gauge
- Temperature range 0° to 200° F (17.7° to 93.3° C)
- MIL-PFR-5606 hydraulic fluid
- Repeated manual opening of input and output valves required to reach desired aircraft pressure
- Finish: Durable Powder Coat Desert Sand

18-4200-1100



Standard Features:

Model: 18-4201-1010 Automatic

- Mounts on standard nitrogen bottles with CGA-580 connector
- 80 cfm (37.8 lps) at 150 psi (10.3 bar) shop air required
- Sturdy welded steel construction
- 15 ft (4.6 m) #4 output hose with 37° JIC female swivel connector
- 5,000 psi (345 bar) certified pressure gauge
- 0 to 160 psi (0 to 11 bar) certified input regulator pressure gauge
- Temperature range 0° to 200° F (17.7° to 93.3° C)
- When input regulator is set at specified pressure the booster automatically shuts down when set pressure is reached
- Finish: Durable Powder Coat Tronair Blue - 18-4201-1010
Durable Powder Coat Green - 18-4201-1010SP

18-4201-1010



Accessory: (for both models)

K-1225 - Regulator Kit operates from nitrogen bottle rather than shop air for remote usage

Specifications:

Model Number	Max Output psi (bar)	Length in (cm)	Width in (cm)	Height in (cm)	Weight lb (kg)
18-4200-1100	3000 (207)	20 (51)	20 (51)	15 (38)	51 (23)
18-4201-1010	4000 (276)	20 (51)	20 (51)	15 (38)	45 (20)

Oxygen Booster

ATTENTION non-North American customers Tronair supplies a standard CGA cylinder connector that will ONLY connect to a North American gas cylinder. Non-North American customers can purchase specific fittings, see the International Gas Cylinder Connector Chart, or must provide their local gas cylinder connection to ensure proper fit.

Standard Features:

- 2,200 psi (151.7 bar) maximum output pressure
- 30:1 volumetric displacement
- 20:1 maximum compression ratio
- Shop air required 80 cfm (37.8 lps) at 90 psi (6.2 bar)
- 0 to 5,000 psi (0 to 345 bar) certified supply gauge
- 0 to 3,000 psi (0 to 207 bar) certified aircraft pressure gauge
- 0 to 160 psi (0 to 11 bar) certified shop air regulator gauge
- Temperature range 0° to 200° F (17.7° to 93.3° C)
- 15 ft (4.6 m) #4 stainless steel braided hose with 37° JIC female swivel connector
- In-line 15 micron nominal filter
- Booster automatically shuts down when aircraft reaches set pressure
- Finish: Durable Powder Coat Green - 20-4500-7000
Durable Powder Coat Tronair Blue - 20-4500-7000SP

CE



20-4500-7000

Specifications:

Model Number	Length in (cm)	Width in (cm)	Height in (cm)	Weight lb (kg)
20-4500-7000	25 (64)	16 (41)	19 (48)	80 (36)

ATTENTION non-North American customers Tronair supplies a standard CGA cylinder connector that will ONLY connect to a North American gas cylinder. Non-North American customers can purchase specific fittings, see the International Gas Cylinder Connector Chart, or must provide their local gas cylinder connection to ensure proper fit.

Standard Features:

- 4 hose manifold to connect bottles with CGA-540 fittings
- High pressure regulator (non venting) 15 to 2,500 psi (1 to 172 bar) certified gauge with 15 ft (4.6 m) #4 output hose with 37° JIC female swivel connector
- 30:1 volumetric displacement
- 20:1 maximum compression ratio
- Oxygen overpressure relief valve set at 2,750 psi (189.6 bar)
- Temperature range 0° to 200° F (-17.7° to 93.3° C)
- Operating instructions located on instrument panel
- In-line 15 micron nominal filter
- Sturdy welded steel construction
- Holds four, domestic or international oxygen cylinders (cylinders not included)
- Maximum bottle pressure 2,250 psi (155 bar)
- 13 in (33 cm) diameter pneumatic tires
- Front wheels lock with towbar in upright position (OSHA Act 1970 Section 5(a)(1) - General Duty Clause - an employer has the general duty to provide a safe work environment free from known hazards. Potential movement of the cart on an uneven surface or incline is eliminated by the locking front wheels)
- Removable back stop adjusts to fit bottle lengths from 48 to 64 in (122 to 163 cm) to hold bottles securely in place (20-4504-7000 and 20-4505-7000 only)
- Towbar with 2³/₁₆ in (5.6 cm) ID eyebolt
- Maximum towing speed 10 mph (16 km/hr)
- Hose storage compartment
- Reflectors to improve night visibility
- Low Profile
- Finish: Durable Powder Coat Green

With Booster Includes Standard Features:

- CE Marked
- Safety limit switch set at 2,500 psi (172 bar) oxygen intensifier (booster) operates with automatic shutdown when the aircraft reaches set pressure

Additional Standard Features:

20-4523-0000, 20-4524-0000

- Easy, one person loading and unloading of 9" diameter x 56" long cylinders, no muscle strains from picking up cylinders OSHA Act 1970 Section 5(a)(1) - General Duty Clause and EU OSHA Directive 90/269/EEC - Manual Handling of Loads)
- Extremely easy rotation to horizontal in use position (OSHA Act 1970 Section 5(a)(1) - General Duty Clause and EU OSHA Directive 90/269/EEC - Manual Handling of Loads)
- Extra secure locking pivot point

Accessories:

- PC-1152 - In-line check (Required if CGA-540 fittings are replaced)
- K-3543 - Extended Bottle Stop for Nitrogen Drive serial numbers AA15960309 and below
- K-4709 - Extended Bottle Stop - serial numbers AB14200311 and above
- K-4313 - Nitrogen Booster Drive Kit - 20-4504-7000 & 20-4505-7000 only
- 20-4524-0000 - Conversion cart (converts standard cart to tiltable)
- PC-1124 - 200 cu ft certified bottle (empty) Color - green



Specifications:

Model Number	Booster	Tiltable	Length in (cm)	Width in (cm)	Height in (cm)	Weight lb (kg)
20-4504-7000	No	No	80 (203)	30.5 (77.5)	37 (94)	350 (159)
20-4505-7000	Yes	No	80 (203)	30.5 (77.5)	37 (94)	380 (172)
20-4523-0000	Yes	Yes	92.8 (235.7)	35.8 (91)	46.7 (118.6)	970 (440)
20-4525-0000	No	Yes	92.8 (235.7)	35.8 (91)	46.7 (118.6)	930 (422)

Oxygen Pressure Regulators & Adaptors

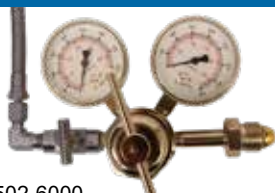

- 20-4502-6000
- Connects with CGA-540 fittings
 - 0-2,500 psi (0-172 bar) output pressure
 - non venting

- K-2717
- Includes PC-1006 and PC-1009

Certified Oxygen Cleaned



- 20-4503-6000
- 1/4 BSPP Mates with 36690 Cylinder Assembly
 - AN 785-3

- 20-4503-6010
- 1/4 BSPP Mates with 36690 Cylinder Assembly
 - 37° JIC Flare



- PC-1006
- 1/4 JIC Flare
 - Mates with AND 10089-3 3/8-24 UNF-2B



- PC-1009
- 1/4 JIC Flare
 - 9/16-18 UNF-2B

Multi-Purpose Cart

Standard Features:

- Service multiple aircraft systems
- Equipped with and air compressor, a generator, a high and low pressure nitrogen system, and hydraulic fluid and engine oil systems
- Nitrogen booster
- Retractable hose reels:
 - 60 ft (18.29 m) for L-1009 oil
 - 60 ft (18.29 m) for Phosphate Ester, Type IV
 - 60 ft (18.29 m) for air compressor
 - 60 ft (18.29 m) for high pressure nitrogen
 - 60 ft (18.29 m) for low pressure nitrogen
- Two 100 ft (30.48 m) extension cords for generator
- Large filtered fill port
- Micron filter after pump
- Sturdy welded steel construction
- Rugged cart has running gear brakes, trailer hitch and space for tool box and three nitrogen tanks
- Front wheels lock with towbar in upright position
- Maximum towing speed 10 mph (16 km)
- Reflectors for night visibility
- Finish: Durable Powder Coat



Specifications:

Model Number	Length in (cm)	Width in (cm)	Height in (cm)	Weight lb (kg)
12-3117-9000	119.75 (304)	73 (185)	68.25 (173)	1,000 (454)

Standard Features:

- 50 ft (15.2 m) input power cable (plug not included)
- 25 ft (7.6 m) #4 cabin pressure sensor hose with 37° JIC female swivel connector
- 2 in (5 cm) ID cabin air supply hose, 25 ft (7.6 m)
- 3 phase, heavy duty 20 hp motor, with 5 year warranty
- Heavy duty starter with solid state overload protection
- High output belt driven blower with oil level indicator
- High efficiency industrial blower silencers
- Certified output and cabin pressure gauges 0 to 15 psi (0 to 1.03 bar)
- Certified door seal pressure gauge 0 to 30 psi (0 to 2.07 bar)
- Air temperature and flow indicators 30 to 300° F (0 to 150° C)
- Air inlet filter, dry element
- Digital flowmeter 15_7607-1000 & 15_7608-1000 ONLY
- Four swivel casters with 8 in (20.3 cm) hard rubber tires, foot brakes, and swivel locks
- Finish: Durable Powder Coat Tronair Blue

Note: SCFM to ACFM conversion could reduce flow by 10%

Voltage Chart

For third character (e.g. 15A7603-1000)

Option	Electrical (60 Hz)	Full Load AMPS
A	208V/60Hz/3ph	59.3
B	230V/60Hz/3ph	53.6
C	380V/60Hz/3ph	31.8
D	460V/60Hz/3ph	26.8
E	575V/60Hz/3ph	21.4

Option	Electrical (50 Hz)	Full Load AMPS
F	200V/50Hz/3ph	61.6
G	220V/50Hz/3ph	51.9
H	380V/50Hz/3ph	30.0
J	415V/50Hz/3ph	29.1
K	440V/50Hz/3ph	28.1

Adaptor Kits:

- Aircraft
- K-1285 - Beech 99/1900, King Air
 - K-1286 - Lear 21, 25, 31, 35, 36
 - K-1288 - Citation III, VI, VII, X, 510, 650, 680, 750
 - K-1359 - Cessna 421, 425, 441, Lear 45
 - K-1360 - Lear 55 (after S/N 125), EMB-120
(A/C must have LearJet Part Number 541*057-8 duct)
 - K-1381 - Piper PA-31T, Aerostar, Cheyenne II & III, Chieftan, Navajo
 - K-1456 - Beech Duke
 - K-1491 - Cessna 337
 - K-1622 - Falcon 10-100, 20-200, 50, 50EX, 900, 900EX, 2000,2000EX
 - K-1623 - Aero Commander
 - K-1660 - MU2, BeechJet, Diamond
 - K-1661 - Lear 24
 - K-2182 - Lear 55 (prior to S/N 125), Lear 60
 - K-2403 - Sabre 65
 - K-2418 - G100, G150, Westwind 1 & 2
 - K-2453 - Pilatus PC-12
 - K-2601 - Citation I, II, V, S/II, CitationJet, CJ1, CJ2, Excel 560XL, Ultra, Ultra Encore
 - K-2610 - HS-125 400-800, Hawker 1000
 - K-3317 - Sino Sweargen SJ30-2

Kit:

- K-3357 - Lear 45 - Stabilizing Anti-Icing Test Kit
- K-4031 - High Pressure Upgrade Kit



15_7603-1000

Specifications:

Model Number	Flow Rate scfm	Rate of Climb Indicator ft/min (cm/sec)	Pressure Relief Valve Set At psi (bar)	Length in (cm)	Width in (cm)	Height in (cm)	Weight lb (kg)
15_7603-1000	0-275	0-4,000 (0-2,032)	13.5 (.93)	70 (178)	48 (122)	49 (125)	1,100 (499)
15_7606-1000	0-275	0-6,000 (0-3,048)	13.5 (.93)	70 (178)	48 (122)	49 (125)	1,100 (499)
15_7607-1000	0-75	0-4,000 (0-2,032)	9 (.62)	70 (178)	48 (122)	49 (125)	1,100 (499)
15_7608-1000	0-75	0-4,000 (0-2,032)	12.5 (.86)	70 (178)	48 (122)	49 (125)	1,100 (499)

Cabin Pressurization Test Units

Standard Features:

- 50 ft (15.2 m) input power cable (plug not included)
- 25 ft (7.6 m) 2 in (5 cm) supply hose
- 30 ft (9.1 m) #4 cabin sense line
- 30 ft (9.1 m) #4 door seal line
- 3 phase, heavy duty 40 hp motor
- Heavy duty starter with solid state overload protection
- High output belt driven blower
- High efficiency industrial blower silencers
- Murphy MPC20 Digital Controller/Display
- Electronic potentiometer controlled flow
- 35-350 scfm (26.3 lbs/min) flow capacity with 2% accuracy reading
- 0-13.5 psig at aircraft capability with .25% accuracy pressure reading
- Certified door seal pressure gauge 0-60 psi (0-4 bar)
- Quiet 77.6 dBA at 3 ft (1 m)
- Heat exchanger for controlled air delivery temperature, 100-140° F (38-60° C)
- Air inlet filter
- Maximum cabin pressure and rate of climb settable warnings
- Hard rubber casters
- Finish: Durable Powder Coat Tronair Blue



Voltage Chart

For third character (e.g. 15A7610-6000)

Option	Electrical (60 Hz)	Full Load AMPS
A	208V/60Hz/3ph	117
B	230V/60Hz/3ph	106
C	380V/60Hz/3ph	57
D	460V/60Hz/3ph	53
E	575V/60Hz/3ph	42

Option	Electrical (50 Hz)	Full Load AMPS
F	380V/415V/440V/50Hz/3ph	62
G	200V/220V/50Hz/3ph	120

Specifications:

Model Number	Flow Rate scfm	Rate of Climb Indicator ft/min (cm/sec)	Length in (cm)	Width in (cm)	Height in (cm)	Weight lb (kg)
15_7610-6000	35-350	0-6000 (0-3048)	83.5 (212)	75.5 (192)	71 (180)	2,000 (907)

Standard Features:

- Continuous duty air supply **REQUIRED** for operation of unit
15-7605-6010:
200 CFM at 100 psi (6.9 bar) minimum (150 psi max)
15-7609-6000-FJ:
109 CFM at 100 psi (6.9 bar) minimum (150 psi max)
- Verify shop air requirement **PRIOR** to ordering
- 1 1/2 in (4 cm) 20 ft. (6.1 m) detachable cabin supply hose with quick disconnect
- 1 in (2.5 cm) ID minimum inlet hose required
- Replaceable air inlet filter element
- 30 ft (9.1 m) cabin sensor feedback hose
- 30 ft (9.1 m) door seal supply hose
- Pressure relief valve set at 13.25 to 13.75 psi (.91 to .95 bar)
- Cabin pressure 0 to 15 psi (0 to 0.97 bar) certified gauges
- System pressure 0 to 30 psi (0 to 2.07 bar) certified gauges
- Door seal pressure 0 to 60 psi (0 to 4 bar) certified gauge
- Certified flow meter
- 150 psi (10.3 bar) maximum shop air supply pressure
- 0 to 6,000 ft/minute (0 to 1,829 m/minute) rate of climb indicator
- ATA transport case with wheels and a retractable handle

Additional Standard Features: 15-7609-6000

- Ambient temperature gauge 50 to 300° F (10 to 149° C)
- Incoming air pressure gauge 0 to 200 psi (0 to 13.8 bar)
- Incoming air shut off valve



Adaptor Kits:

Aircraft

- K-1285 - Beech 99/1900, King Air
- K-1286 - Lear 21, 25, 31, 35, 36
- K-1288 - Citation III, VI, VII, X, 510, 650, 680, 750
- K-1359 - Cessna 421, 425, 441, Lear 45
- K-1360 - Lear 55 (after S/N 125), EMB-120
*(A/C must have LearJet Part Number 541*057-8 duct)*
- K-1381 - Piper PA-31T, Aerostar, Cheyenne II & III, Chieftan, Navajo
- K-1456 - Beech Duke
- K-1491 - Cessna 337
- K-1622 - Falcon 10-100, 20-200, 50, 50EX, 900, 900EX, 2000, 2000EX
- K-1623 - Aero Commander
- K-1660 - MU2, BeechJet, Diamond
- K-1661 - Lear 24
- K-2182 - Lear 55 (prior to S/N 125), Lear 60
- K-2403 - Sabre 65
- K-2418 - G100, G150, Westwind 1 & 2
- K-2453 - Pilatus PC-12
- K-2601 - Citation I, II, V, S/II, CitationJet, CJ1, CJ2, Excel 560XL, Ultra, Ultra Encore
- K-2610 - HS-125 400-800, Hawker 1000
- K-3317 - Sino Sweargen SJ30-2
- K-4943 - F-16 - Sensing Adapter Hose - Required
(included with 15-7609-6000-FJ)
- K-4945 - A-10 - Sensing Adapter Hose
- K-4946 - A-10, F-16 - Supply Adapter Hose - Required
(included with 15-7609-6000-FJ)

Kit:

- K-3357 - Lear 45 - Stabilizing Anti-Icing Test Kit

Specifications:

Model Number	Flow Range scfm	Length in (cm)	Width in (cm)	Height in (cm)	Weight lb (kg)
15-7605-6010	20 to 200	27.5 (70)	29 (74)	29 (74)	85 (39)
15-7609-6000-FJ	15 to 165	27.5 (70)	29 (74)	29 (74)	85 (39)

Leak Fluid Dispenser

Standard Features:

Model: 15-7601-6000

- Dispense leak detecting fluid to determine if air is escaping when cabin is pressurized
- Dimensions:
Width: 8 in (74 cm)
Height: 20 in (74 cm)
Weight: 85 lb (39 kg) empty weight



Mobile 4 US Ton AC Environment Control Carts

Standard Features:

Models: 17-7505-7000 Gasoline, 17-7524-0000 LPG

- Cooling capacity 45,000 Btu/hr output
- 1,600 cfm maximum air flow
- Refrigerant type R-410A is environmentally safe
- Hermetic compressor belt driven with over current and over temperature protection
- 1,200 - 2,000 cfm propeller type condenser fan
- 12 in (30 cm) diameter, 25 ft (7.6 m) long output hose
- Dual suction high density filters
- 115 volt (ground fault interrupt) external AC utility outlet with 15 amp fuse and switch - 17-7505-7000
- Sturdy welded frame with 16 gauge sheet metal cabinet
- Noncorrosive, sloped condensation drain pan, meets ASHRAE 62-89 (IAQ) standard
- Engine:
 - 20 HP Honda - 17-7505-7000
 - 23 HP Subaru - 17-7524-0000
- Tank Capacity:
 - 13 gal (49.2 l) tank with run time of 8 hours - 17-7505-7000
- 240/1 phase, 13.5 kW AC output
- Units are designed to cool and/or heat an aircraft through a window or door opening
- Trailer mounted - Finish: Black
- Finish: Acrylic Enamel Gray

Available Option All Models:

- 8.7 kW Heater 29,700 Btu/hr maximum thematically controlled (Btu output will vary with input voltage) insert an "A" as the third digit of the model number (e.g. 17A7503-7000)

Standard Features:

Model: 17-7503-7000 AC Plug-in

- Cooling capacity 45,000 Btu/hr output
- 1,600 cfm maximum air flow
- Refrigerant type R-410A is environmentally safe
- Hermetic compressor belt driven with over current and over temperature protection
- 1,200 - 2,000 cfm propeller type condenser fan
- 12 in (30 cm) diameter, 25 ft (7.6 m) long output hose
- Dual suction high density filters
- 115 volt (ground fault interrupt) external AC utility outlet with 15 amp fuse and switch
- AC plug-in: 208, 230, 400, 460, and 575 volt
- 1 or 3 phase (single phase not available in all voltages)
- 50 ft (15.3 m) long power cord
- Sturdy welded frame with 16 gauge sheet metal cabinet
- Noncorrosive, sloped condensation drain pan, meets ASHRAE 62-89 (IAQ) standard
- Unit is designed to cool and/or heat an aircraft through a window or door opening
- Trailer mounted - Finish: Black
- Finish: Acrylic Enamel Gray

Voltage Chart for eighth character (e.g. 17-7503B7000)

Option	Electrical	AMPS without Heater	AMPS with Heater
B	208V/60Hz/1ph	41.2	50.4
C	230V/60Hz/1ph	41.2	56.4
F	208V/60Hz/3ph	25.9	48.2
G	230V/60Hz/3ph	25.9	54.6
J	460V/60Hz/3ph	13.8	24.3



Specifications:

Model Number	Length in (cm)	Width in (cm)	Height in (cm)	Weight lb (kg)
17-7503_7000	104 (264)	61 (156)	63 (160)	1,300 (590)
17-7505-7000	132 (335)	61 (156)	64 (163)	1,950 (885)
17-7524-0000	154 (191)	61 (156)	64 (163)	2,000 (907)



Standard Features:

- Powered by the award winning Doosan Tier 4f electronic engine with full-authority electronic controls for more precise control over the performance of the engine
- Extended service intervals using extended service filters and lubricants, up to 500 hours between scheduled service
- Engine operates with Ultra-low Sulphur Diesel fuel
- Fuel/water separator with water-in-fuel sensor and electronic indication
- Large 35 gallon, high density cross-linked polyethylene fuel tank for 8 + hours of use
- Low fuel warning and no fuel shutdown system
- Shut down on low oil pressure and high engine temperature commonly seen listed as (LOP/HET protection)
- 12 volt control and starting circuitry for easy cold weather starting
- Automated glow plug control for cold weather starting
- 120 V Block Heater for cold weather starting
- Insulated engine compartment for cold weather starting and sound dampening
- Large engine Digital Display and Diagnostics module (DDD), this is a multi-function tool to view engine parameters and fault codes
- Automatic 60 second power off delay engine shutdown for turbo protection
- 3 year engine warranty
- Powerful 80kw, AVR and 90kVA alternator with SCR regulation
- Maintenance free, long life single bearing
- Automatic output build-up and protection
- Cable head sensing and output drop compensation system ensures full power is provided to aircraft
- Aircraft cable head interlock circuit
- Wiring and color code in accordance with CE, NFPA and NEC
- 30 ft (9.1 m) AC output cable
- Durable, compact, maneuverable, trailer mounted unit with fifth wheel steering
- Front wheel scrub brake for simplicity
- Weather resistant powder coated sheet metal to prevent corrosion
- Corner lights and stack light
- Large cable trays for easy cable stowage
- Finish: Durable Powder Coat Tronair Blue

Additional Features:

Model: 11-4290-0000

- Unit allows simultaneous use of 400 Hz AC and 28.5 VDC
- Powerful 80kw AVR and 90kVA alternator with SCR regulation and ripple filter for ultra low DC output ripple
- Adjustable peak output current limiting control, 2,000 amp peak, 600 amp continuous output
- 30 ft (9 cm) DC output cable



Specifications:

Model Number	Output	Length in (cm)	Width in (cm)	Height in (cm)	Weight lb (kg)
11-4090-0000	400 Hz AC, 90 kVA	113.5 (288)	79 (200)	74.5 (189)	3,800 (1,724)
11-4290-0000	400 Hz AC, 90 kVA, 28.5 VDC	113.5 (288)	79 (200)	74.5 (189)	4,000 (1,814)

28.5 VDC Tier 4 Diesel Ground Power Units

Standard Features:

- Powered by the award winning Doosan Tier 4f electronic engine with full-authority electronic controls for more precise control over the performance of the engine
- Extended service intervals using extended service filters and lubricants, up to 500 hours between scheduled service
- Engine operates with Ultra-low Sulphur Diesel fuel
- Fuel/water separator with water-in-fuel sensor and electronic indication
- Large 35 gallon, high density cross-linked polyethylene fuel tank for 26 + hours of use
- Low fuel warning and no fuel shutdown system
- Shut down on low oil pressure and high engine temperature commonly seen listed as (LOP/HET protection)
- 12 volt control and starting circuitry for easy cold weather starting
- Automated glow plug control for cold weather starting
- 120 V Block Heater for cold weather starting
- Insulated engine compartment for cold weather starting and sound dampening
- Large engine Digital Display and Diagnostics module (DDD), this is a multi-function tool to view engine parameters and fault codes
- Automatic 60 second power off delay engine shutdown for turbo protection
- 3 year engine warranty
- Powerful 38kw, six phase alternator, rectifier and ripple filter for ultra low DC output ripple
- Maintenance free, long life single bearing
- Automatic voltage build-up and protection
- Adjustable peak output current limiting control, 2,000 amp peak, 600 amp continuous output
- Cable head voltage sensing and output voltage drop compensation system ensures full power is provided to aircraft
- Aircraft cable head interlock circuit
- Wiring and color code in accordance with CE, NFPA and NEC
- 30 ft (9.1 m) DC output cable
- Durable, compact, maneuverable, trailer mounted unit with fifth wheel steering
- Front wheel scrub brake for simplicity
- Weather resistant powder coated sheet metal to prevent corrosion
- Corner lights and stack light
- Large cable trays for easy cable stowage
- Finish: Durable Powder Coat Tronair Blue



Specifications:

Model Number	Length in (cm)	Width in (cm)	Height in (cm)	Weight lb (kg)
11-2820-0000	96.5 (245)	66.25 (168)	61 (155)	2,900 (1,315)

Standard Features:

- Engine operates with gasoline
- 150 amps continuous at 28 VDC, 1000 amps peak
- 6 heavy duty, maintenance free, lead acid batteries
- Soft start for avionics protection
- 2 cylinder, air cooled Tier 4 Kohler engine
- Internal battery charger recharges in minutes
- 20 ft (6.1 m) 4/0 output cable with AN 2551 connector aircraft DC plug
- 13 in (33 cm) tubless pneumatic tires - 11-6644C1010
- Developed for the US Army - 11-6644C1010-A1
- Rugged frame for transport across rough terrain - 11-6644C1010-A1
- Towing speeds up to 20 mph - 11-6644C1010-A1
- 0 to 125° F (-18 to 52° C) maximum aircraft starting and electric service temperature range
- Electric starter switch
- Aircraft power cable On/Off switch
- Oil-bathed fly weight type governor
- OHC 18 HP
- Illuminated instrument panel
- Hourmeter
- 0 to 300 ammeter
- 0 to 2,000 aircraft ammeter
- 0 to 50 volt DC voltmeter
- 13 gal (49 l) fuel tank
- Meets California Clean Air
- This unit NOT recommended for starting the TPE 331 engine
- Finish: Durable Powder Coat Tronair Blue



11-6644C1010

Specifications:

Model Number	Length in (cm)	Width in (cm)	Height in (cm)	Weight lb (kg)
11-6644C1010	60.5 (154)	47 (119)	46.75 (119)	1300 (590)
11-6644C1010-A1	72 (183)	64 (163)	46.75 (119)	1300 (590)

28.5 VDC Solid State Rectifiers

Standard Features:

- 2 year Tronair Platinum warranty
- Quietest performing unit, 20dB nominal
- Easy to change multi-volt transformer
- Low profile fits under most wings
- 25 KVA transformer ensures full power during engine starts
- Clean power, low voltage ripple <.2 VDC RMS
- Energy saving thermal control cooling fan
- MIL-STD-704F, 18" NEC and CE compliant
- Adjustable current limit output
- Simple to use controls
- Input:
 - Voltage Range 200 - 480V +/- 10%
 - Power 25 KVA
 - Phase 3
 - Frequency 50 or 60 Hz
- Output:
 - Voltage 28.5 VDC
 - Current Limit (adjustable) ... 100-2000 max amps DC
 - Continuous Power 600 amps at 28.5 VDC
 - Starting Power 2000 amps max
- Protection:
 - Output Over/Under Voltage
 - Output Over Current
 - Input Phase Loss Detection, missing phase
 - Input Over/Under Voltage
 - Input Circuit Breaker 100 amps
 - Transformer Over Temperature
 - SCR Over Temperature
 - Thermal Protection:
 - Cooling Fan Temp controlled variable speed
- Duplex GFCI Weatherproof Receptacle with Cover:
 - 50 Hz Models - 15 A, 220 VAC
 - 60 Hz Models - 15 A, 115 VAC
- DC Output Cables:
 - Single Models - 20 ft (6.1 m)
 - Dual Models - 20 ft (6.1 m) and 50 ft (15.24 m)
 - (50 ft cable NOT used for starting engines)
- Long life LED indication lights that double as a diagnostic tool
- Sturdy all weather IP54 enclosure with cord hangers
- 50 ft (15.2 m) input cable (standard)
- 100 ft (30.5 m) input cable (optional)
- 20 ft (6.1 m) output cable with AN2551 aircraft DC connector on mobile units
- Main disconnect switch for input power
- DC On/Off switch control
- Emergency stop switch
- Large 9 in (23 cm) rubber rigid and lockable swivel casters for easy maneuverability
- Finish: Durable Powder Coat Tronair Blue



112860S0100

Tronair vs Competitors (at unit)

- Tronair
- Competitor P
- Competitor H
- Competitor C
- Competitor F

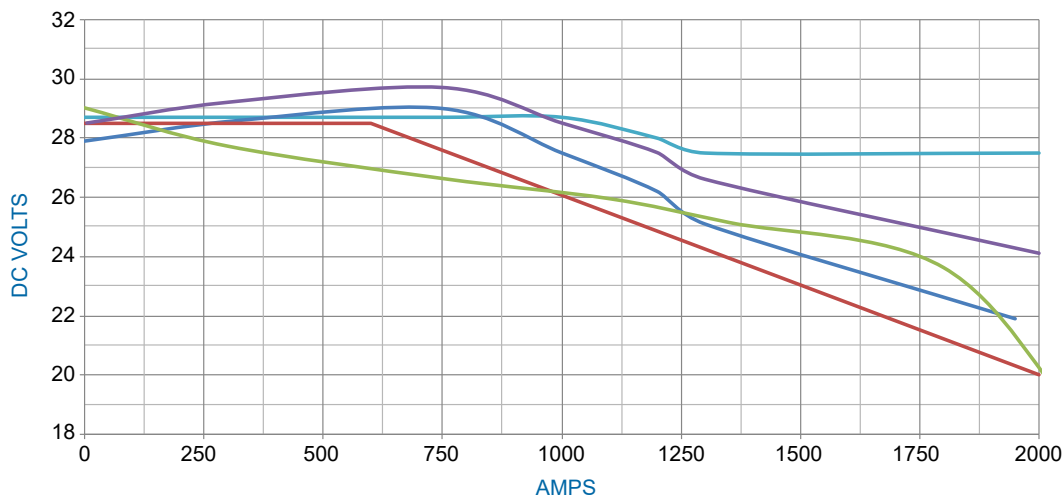

Specifications:

Model Number		Input Hz	Input Cable Length ft (m)	Length in (cm)	Width		Height in (cm)	Weight (Est.)	
Single Output Cable	Dual Output Cable				Single in (cm)	Dual in (cm)		Single lb (kg)	Dual lb (kg)
112860S0000	112860D0000	60	—	42 (107)	31 (79)	33 (84)	33 (84)	680 (308)	730 (331)
112860S0100	112860D0100	60	50 (15.2)	42 (107)	31 (79)	33 (84)	33 (84)	702 (318)	750 (340)
112860S0200	112860D0200	60	100 (30.5)	42 (107)	31 (79)	33 (84)	33 (84)	750 (340)	800 (363)
112850S0000	112850D0000	50	—	42 (107)	31 (79)	33 (84)	33 (84)	680 (308)	730 (331)
112850S0100	112850D0100	50	50 (15.2)	42 (107)	31 (79)	33 (84)	33 (84)	702 (318)	750 (340)
112850S0200	112850D0200	50	100 (30.5)	42 (107)	31 (79)	33 (84)	33 (84)	750 (340)	800 (363)

Standard Features:

- For use with the Flexible Engine Diagnostic System (FEDS) aircraft engine testing
- Quiet operation, 52dB during nominal operation, 60dB maximum
- 20 A, 115 VAC, duplex GFCI weatherproof receptacle with cover
- MIL-STD-704F, 18" NEC and CE compliant
- Low profile and compact design
- Sturdy all weather IP54 enclosure with cord hangers
- Long life LED indication lights that double as a diagnostic tool
- Emergency stop switch
- Large 9 in (23 cm) rubber rigid and lockable swivel casters for easy maneuverability
- Finish: Durable Powder Coat yellow

Input:

- Easy to change multi-volt transformer
- Main power disconnect switch
- 25 KVA transformer ensures full power during engine starts
- Voltage Range 200 - 480V +/- 10%
- Frequency 50 Hz / 60 Hz

Output:

- Current Limit (adjustable) 100-2000 max amps DC maximum
- Nominal Continuous Power 600 amps at 28.5 VDC
- DC Voltage (adjustable) 16-35V
- Nominal DC Voltage 28.5 VDC
- Clean power, low voltage ripple <.2 VDC RMS
- DC On/Off switch on control panel
- Remote DC output On/Off engine start capable
- Remote DC voltage sensing
- Simple to use operator control panel



112860S0000FEDS

Protection:

- Output over/under voltage
- Output over current
- Input phase loss detection, missing phase
- Input over/under voltage
- Input shunt-trip circuit breaker 100 amps
- Transformer over temperature
- SCR over temperature
- Energy saving variable speed thermal control cooling fan

Options:

- 50 ft (15.2 m) input cable
- 100 ft (30.5 m) input cable
- 20 ft (6.1 m) output cable with AN2551 aircraft DC plug
- 50Hz AC model with 20 Amp, 220 VAC with weatherproof outlet and cover

Specifications:

Model Number	Length in (cm)	Width in (cm)	Height in (cm)	Weight (Est.) lb (kg)
112860S0000FEDS	42 (107)	33 (84)	33 (84)	680 (308)

24 VDC Battery Cart - 1,000 Amps Peak

Standard Features:

- Delivers 1,000 amps starting power
- Rugged welded steel construction
- 24 VDC output
- 20 ft (6.1 m) DC output cable with AN2551 connector
- Soft start protects avionics from voltage spikes
- 10 in (25 cm) pneumatic tires
- Contains (6) heavy duty, maintenance free lead acid batteries, with cold cranking amps each at 0° F (-18° C)
- Optional battery charger plugs directly into instrument panel
- Finish: Durable Powder Coat Tronair Blue



11-6602-1000

Specifications:

Model Number	Length in (cm)	Width in (cm)	Height in (cm)	Weight lb (kg)
11-6602-1000	33 (84)	35 (89)	24 (61)	465 (211)

BATTERY CHARGER

92-0552-9010 120 Volts - 60 Hz

92-0552-9011 220 Volts - 50 Hz

Output: 6/12/24 Volts DC

100/80/50 Amps

550 Amp Boost/Crank



Nickel Cadmium Battery Charger/Analyzer

Standard Features:

- Fully automatic operation
- Solid state circuitry and state-of-the-art components
- Automatic battery temperature sensing
- Battery over temperature protection circuit
- Services from 1 to 50 cells simultaneously
- Capable of discharging two batteries (limited to 20 amps)
- Adjustable current flow from 0 to 50 amps
- Input voltages 208/230 AC 50 or 60 Hz



11-6610-6000

Specifications:

Model Number	Length in (cm)	Width in (cm)	Height in (cm)	Weight lb (kg)
11-6610-6000	19 (48)	20 (51)	15 (38)	120 (54)

Standard Features:

- Safely transfer aircraft fuel
- Filters particles up to 1/2 micron
- Air operated to eliminate spark hazard
- 10 cfm (4.7 lps) at 50 psi (33 bar) shop air required
- Diaphragm pump with air inlet control valve and regulator certified pressure 0 to 100 psi (0 to 6.8 bar) gauge
- 2 static discharge reels: 20 ft (6 m) and 50 ft (15 m) long
- 50 psi (33 bar) maximum operating pressure
- 50 psi (33 bar) safety valve
- 98% particle removal
- #16 discharge hose with shut-off valve
- #16 suction hose with shut-off valve
- Welded steel cart with tool tray and 14 in (35.6 cm) wheels
- 15 gpm (57 lpm) flow
- Finish: Durable Powder Coat Tronair Blue



07-3000-1921

Accessory:

- K-4668 - Defuler Totalizer

Specifications:

Model Number	Totalizer	Discharge Hose ft (m)	Suction Hose ft (m)	Length in (cm)	Width in (cm)	Height in (cm)	Weight lb (kg)
07-3000-1921	No	15 (4.5)	40 (12.2)	25 (64)	34 (86)	41 (104)	140 (63)
07-3000-1921-A3	Yes (measures in liters)	15 (4.5)	40 (12.2)	25 (64)	34 (86)	41 (104)	140 (63)
07-3000-0922	Yes (measures in gallons)	15 (4.5)	40 (12.2)	25 (64)	34 (86)	41 (104)	140 (63)
07-3023-0900	No	40 (12.2)	two 25 (7.6) three 15 (4.5)	25 (64)	34 (86)	41 (104)	140 (63)

Fuel System Leak Test Unit

Standard Features:

- Filters particles up to 1/2 micron
- Air operated motors drive pumps
- Air operated to eliminate spark hazard
- 10 cfm (4.7 lps) at 50 psi (33 bar) shop air required
- Air inlet control valve, regulator and lubricator
- 2 static discharge reels: 20 ft (6 m) and 50 ft (15 m) long
- 50 psi (33 bar) maximum operating pressure
- 50 psi (33 bar) safety valve
- 98% particle removal
- 40 ft (12.2 m) #16 discharge hose
- 20 ft (6.1 m) #16 suction hose with shut-off valve
- Welded steel cart with tool tray and 14 in (35.6 cm) wheels
- 3 flow settings
 - .5 - 1 gpm (1.9 - 3.8 lpm)
 - .5 - 5 gpm (1.9 - 18.9 lpm)
 - 1 - 15 gpm (3.8 - 56.8 lpm)
- K-4409 - Engine hose
- K-4410 - APU hose
- K-4739 - Jumper Plug kit (92700-20507-041)
- Finish: Durable Powder Coat Tronair Blue



07-3015-0900

Specifications:

Model Number	Length in (cm)	Width in (cm)	Height in (cm)	Weight lb (kg)
07-3015-0900	26 (65)	34.5 (88)	43 (109)	300 (136)

Fuel Sample Test Tools



Specifications:

Model Number	Bits	Fluid Capacity oz (l)	Rim Diameter in (cm)	Length in (cm)	Weight lb (kg)
07-3001-4900	Wide Flat Head Custom	36 (1.06)	4 ½ (11.4)	19 ½ (50)	1 ¼ (.567)
07-3005-6900	Slotted 12-14; Phillips #2, #3, Pin 1/8 x 7/8	32 (.95)	4 ¾ (12.1)	9 ³/₁₆ (23)	3 (1.36)
07-3006-6900 *	Slotted 4-5, 12-14; Phillips #2, #3; Hex 1/8, 3/32, 5/32, 4mm	32 (.95)	4 ¾ (12.1)	15 ¾ (40)	3 (1.36)
07-3007-6900	Hex 5/8	32 (.95)	2 ⁵/₁₆ (6)	19 ¼ (49)	1 (.454)
07-3008-6900	Conical Head	32 (.95)	1 (2.5)	80 (203)	2 (.907)
07-3009-6900	Slotted 8-10; Phillips #2, #3; Hex 1/8, 3/32, 5/32	10.7 (.32)	2 ½ (6.4)	13 (33)	2 (.907)
07-3016-6900	Hex 5/32	32 (.95)	3.15 (8)	25.22 (65)	1 (.454)
07-3018-6900	Phillips #2	32 (.95)	4 ¾ (12.1)	7 ½ (19)	3 (1.36)
07-3020-6900	Pozidriv #2, Hex 4mm	32 (.95)	5 ⅞ (13)	14 ⁷/₁₆ (37)	3 (1.36)
07-3022-6900	Custom Flat Head	36 (1.06)	4 ½ (11.4)	14 ½ (37)	3 (1.36)
07-3026-6900	Phillips #2	16 (.47)	3 ¾ (9.5)	6 ½ (16.5)	3 (1.36)
07-3028C6900	Phillips #2	12.2 (.336)	2 ½ (6.4)	8 ½ (21.6)	3 (1.36)

*Optional Custom Falcon 50 (H-2599 Bit)

• Optional Custom Lear 35 (H-2598 Bit)

Fuel Tools

Specifications:

Model Number	Purpose	Model Number	Purpose
07-3004-6900	Fuel Valve Test Tool	07-8062-6000	Fuel Calibration Test Unit
07-3014-0900	Fuel Leakage Test Box	07-8066-4000	Fuel Boost Pump Valve Door Puller
07-8017-6000	Fuel Drain Valve Tool	07-8091-6000	Digital Fuel Quantity Test Unit
07-8018-4000	Pressure Relief Fuel System Test Tool	07-8092-6000	Digital Fuel Quantity Test Unit
07-8019-4000	Fuel Boost Pump Ring Wrench		

Fuel Sump Unit

Standard Features:

- Air operated to eliminate spark hazard
- 10 cfm (4.7 lps) at 50 psi (33 bar) shop air required
- Clear polycarbonate sight glass, 1 gal (3.8 l) capacity
- 2 static discharge reels: 20 ft (6 m) and 50 ft (15 m) long
- 50 psi (33 bar) maximum operating pressure
- 50 psi (33 bar) safety valve
- 20 ft (6 m) #12 suction hose with shut-off valve
- Welded steel frame
- Finish: Acrylic Enamel Tronair Blue

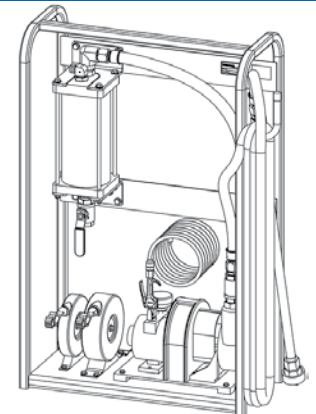

Specifications:

Model Number	Length in (cm)	Width in (cm)	Height in (cm)	Weight lb (kg)
07-3027-0900	14 (36)	29.5 (75)	42.5 (108)	125 (57)

RAM AIR TURBINE (RAT) FLOW CONTROL TEST UNIT

Standard Features:

Models: 13-6600-3600 (A318, A319, A320, A321, A330, A340 serial number 1047 and later)
 Replaces: AGE-11212 Ground Test Tool (suitcase)
 89415Z Flow Control Test Unit (tub)

- Ground test motor (AGE10600D) attaches easily to RAT lower gearbox using provided fasteners
- Powered from aircraft electrical system; no batteries or external power source
- Ground Test Tool hydraulic motor provides exact torque curve required to properly test RAT performance
- 20 ft. (6 m) hose lengths provide flexibility in positioning hydraulic power cart at aircraft
- Recessed, side mounted quick disconnects for easy external connection of hydraulic hoses, allowing all cabinet doors to remain closed during testing
- Both front and rear cabinet doors open fully for easy access to stored components, manuals and tools
- Ergonomic controls and instrumentation
- Easy-to-read digital data displays for RAT speed, pressure and flow
- Front panel clipboard rest for recording test procedure and holding data sheets
- Mounted on casters with side handles for ease of moving from storage to aircraft
- Floor lock for securing cart in position at aircraft
- Finish: Durable Powder Coat Tronair Blue
- 13-6600-3600 Dimensions:
 Length: 48 in (122 cm)
 Width: 23 (58)
 Height: 57 (145)
 Weight: 600 (272)



AGE10600D
Ground Test Tool



13-6600-3600

COMPLETE RAM AIR TURBINE TEST SYSTEM

(for Airbus A318, A319, A320, A321, A330, A340 serial number 1047 and later)

Order the 13-6600-3600, the AGE10600D GTT and the 5833/5A33 series HPU for a complete system (all units sold separately)

Specifications:

Model Number	Required Ground Test Tool	Manufacturer/Aircraft	Pressure psi (bar)	Required HPU Series
13-6600-3600	AGE10600D	Airbus A319, A320, A321, A330, A340 Boeing 747-8	3,000 (207)	5833, 5A33

(all units sold separately)

Ram Air Turbine (RAT) Test Equipment

RAM AIR TURBINE (RAT) GROUND TEST TOOL

Standard Features:

- The RAT Test Tool, powered by a suitable hydraulic cart, is used to back drive the RAT during ground testing
- The hydraulic motor provides power and speed capabilities consistent with the requirements of the ground test procedures
- 20 ft (6.1 m) long pressure supply and return hoses
- Heavy duty case - may be used for easy shipping and storage



AGE17078
RAT Test Tool



AGE13604A
RAT Test Tool

Specifications:

Model Number	Manufacturer/Aircraft	Pressure psi (bar)	Required HPU Series
AGE10600D	Airbus A319, A320, A321, A330, A340 Boeing 747-8	3,000 (207)	5833, 5A33
AGE13604A	Embraer ERJ-170, ERJ-175, ERJ-190, ERJ-195, Lineage 1000 China ARJ Mitsubishi MRJ Sukhoi SuperJet S100	3,000 (207)	5731
AGE17073A	Bombardier CRJ, CL604, Challenger	3,000 (207)	5631
AGE17074A	Embraer Legacy 450, 500 Gulfstream G650	3,000 (207)	---
AGE17077B	Boeing B787	5,000 (345)	5933, 5L33
AGE17078	Airbus A380	5,000 (345)	5933, 5L33
AGE17079A	Casa A400M	5,000 (345)	5933, 5L33
AGE17080A	Airbus A350	5,000 (345)	5933, 5L33
AGE17631B	Bombardier C-Series	3,000 (207)	5833, 5A33
AGE19023	Comac C919	3,000 (207)	5833, 5A33

ACTUATOR ADJUSTMENT TOOL

- For adjustment of the RAT actuator arm

13-6605-6000

Specifications:

Model Number	Reference (RAT)	Manufacturer/Aircraft
13-6605-6000	AGE13603	Embraer 170/195 China ARJ Mitsubishi MRJ Sukhoi S100
13-6615-6000	AGE13721	Bombardier CRJ, Challenger Falcon 7X Gulfstream G-650



GTT PRESSURE MONITORING BOX

Standard Features:

- Required for use with AGE17077B, may be used with AGE17078, AGE17079A, AGE17080A
- Accurately monitor and readout inlet and discharge pressure at the GTT
- Skydrol/Hyjet resistant heavy duty stainless steel enclosure
- Skydrol/Hyjet resistant external cables and hardware
- Large calibrated, digital displays for easy readouts
- 30 ft (10 m) harness
- Large inlet and discharge cable labels for easy identification
- Universal input power, 90VAC - 240VAC, 50Hz - 60 Hz
- 9 ft (3 m) North American power cord
- 9 ft (3 m) international power cord
- Cable storage in unit
- Cable test port
- Screw on J3 connectors ensure a secure fit and connection
- Portable, lightweight and compact tool
- Ergonomic handle for easy transport
- Wiring connection diagram



Specifications:

Model Number	Length in (cm)	Width in (cm)	Height in (cm)	Weight lb (kg)
AGE18380	11.8 (30)	9.8 (24.9)	8.4 (21.3)	15 (6.8)

Hydraulic Power Units - Ordering Instructions

- Step 1 – Determine the size of the Hydraulic Power Unit required. Check the aircraft maintenance manual, or refer to Tronair's Aircraft Tool and Equipment list at tronair.com
- Step 2 – Select the correct fluid type that matches your aircraft
- Step 3 – Determine if the unit requires a CE mark and/or an Electric Soft Start (call for soft start availability)
- Step 4 – Choose a paint color from the available colors
- Step 5 – Select quick disconnect couplings to attach the hoses to the aircraft bulkhead fittings. These couplings will become part of the model number sequence, they are attached to hose ends upon receipt (pgs 127 - 131)
- Step 6 – Determine the input voltage the Hydraulic Power Unit will be operating at. When ordering, the most common error is selecting incorrect input voltages (To check input voltage, measure from L1 to L2, L1 to L3, and L2 to L3. The highest voltage obtained from these readings is the correct input voltage)
- Step 7 – Select additional features to customize your unit. We offer a broad range of options to enhance your Hydraulic Power Unit to your particular needs or budget. Options listed in the chart must be in alphabetical order. Refer to the option matrix (below) for standard features per model number

MANDATORY INFORMATION

OPTIONS (alphabetical order)

5																			
---	--	--	--	--	--	--	--	--	--	--	--	--	--	--	--	--	--	--	--

HYDRAULIC POWER UNIT

char	build
1	CE Compliant
3	CE Soft Start

char	fluid
1	MIL-PRF-5606
2	MIL-PRF-83282
3	Phosphate Ester (Skydrol)
4	MIL-PRF-87257
5	Phosphate Ester (HyJet V)*

*limited availability

char	voltage/freq/phase	input cord	
0	208V/60Hz/3PH	50 ft (15.2 m)	
1	230V/60Hz/3PH		
2	380V/60Hz/3PH		
3	460V/60Hz/3PH		
4	575V/60Hz/3PH		
5	200V/50Hz/3PH		input cord length
6	220V/50Hz/3PH		
7	380V/50Hz/3PH		
8	415V/50Hz/3PH		
9	440V/50Hz/3PH		
Q	208V/60Hz/3PH	100 ft (30.5 m)	
R	230V/60Hz/3PH		
S	380V/60Hz/3PH		
T	460V/60Hz/3PH		
U	575V/60Hz/3PH		
V	200V/50Hz/3PH		input cord length
W	220V/50Hz/3PH		
X	380V/50Hz/3PH		
Y	415V/50Hz/3PH		
Z	440V/50Hz/3PH		
E	220V/50Hz/1 Phase**	15 ft (4.6 m)	
F	120V/60Hz/1 Phase**		

**available on 5Z only

char	description	
A	25 ft hoses	
B	50 ft hoses	
AA	25 ft hoses (split system)	
AB	25 ft hoses and 50 ft hoses	
BB	50 ft hoses (split system)	
C	split system	
D	split system w/crossover check	
3	triple split system*	
E	hourmeter (50HZ)	
F	hourmeter (60HZ)	
G	voltage monitor (200-230V)	
H	voltage monitor (380V)	
I	voltage monitor (415-460V)	
J	voltage monitor (575V)	
K	pyrometer	
L	electric reservoir level	
M	hand pump	
N	towing/trailer package	
P	reservoir overflow return	
Q	calibration port	
R	electric filter clogged indicator	
S	electric over temperature	
T	return back pressure w/sight gauge	
U	return sight gauge	
V	return back pressure	
W	return filter** // contamination monitor***	
X	height ext. cart** // 50 ft hand pump hose**	
Y	return sight gauge (split system)	
Z	no return valves (split system)	
1	return back pressure (split system)	
2	red stack light	
3	triple system	
4	drip pan	
5	remote e-stop (50 ft)	
6	return sight gauge (triple split system)*	
7	hand pump (large displacement)*	
8	pressure reducing valve (split system)*	
9	low flow hoses (single system)*	

* limited availability
** 50 series only // ***all other models

FULL LOAD AMPS											
supply voltage: 60 hz - 3 phase					supply voltage: 50 hz - 3 phase						
HP	208 VAC	230 VAC	380 VAC	460 VAC	575 VAC	HP	200 VAC	220 VAC	380 VAC	415 VAC	440 VAC
3	9.2	8.4	4.8	4.2	3.7	3	8.4	9.3	4.6	4.6	4.6
5	15	13.6	7.8	6.8	5.4	5	13.0	15.0	7.5	7.5	7.5
10	28.8	26.0	15.7	13.0	10.4	10	26.0	26.0	13.0	13.0	13.0
15	44.2	40.0	24.2	20.0	16.0	15	48.0	41.0	23.7	23.0	22.0
20	59.3	53.6	31.8	26.8	21.4	20	61.6	51.9	30.0	29.1	28.1
25	73.0	66.0	38.0	33.0	26.4	25	75.0	72.0	36.0	36.0	35.0
30	86.3	78.0	42.5	39.0	31.2	30	89.0	78.0	45.0	43.0	39.0
40	117.2	106.0	57.0	53.0	42.0	40	120.5	103.0	62.0	60.0	56.0
75	N/A	N/A	103.8	92.0	73.6	75	N/A	N/A	107.0	105.0	92.0
100	N/A	N/A	130.0	121.0	96.8	100	N/A	N/A	146.0	134.0	124.0
150	N/A	N/A	192.0	171.0	137.0	150	N/A	N/A	208.0	190.0	179.0

char	60 Hz		50 Hz		psi	bar	hp	kW
	gpm	lpm	gpm	lpm				
0	6	23	5	19	1800	124	3	2.2
1	6	23	5	19	3000	207	5	3.7
2	10	38	8	32	3000	207	15	11
3	11	42	9	35	5000	345	25	19
4	15	57	13	47	3500	241	25	19
J	20	76	17	63	4000	276	30	22
5	25	95	21	79	5000	345	75	56
6	34	129	28	107	4000	276	40	30
7	34	129	28	107	4000	276	75	56
8	63	239	53	199	4000	276	100	75
9	63	239	53	199	5000	345	150	112
A	63	239	53	199	4000	276	150	112
L	63	239	53	199	5000	345	150	112
Z	0.8	2.8	0.8	2.8	1500	103	0.8	0.6
B	Citation pkg A				5	3.7		
D	JPATS				10	7.5		
E	Pilatus				10	7.5		
F	Citation pkg B				3	2.2		
G	Gulfstream (factory)				40	30		
H	Dash 8-100/300 only				15	11		
K	Gulfstream (G100/200)				25	19		
P	Falcon 7X				30	22		
Q	Falcon 7X (factory)				40	30		
R	Agusta (AB139, factory)				30	22		

Quick Disconnect (Hydraulic Couplings)

char	color
0	desert sand
1	Tronair blue (standard)
2	safety yellow
3	red
4	jade green
5	snow white
7	gray
9	olive drab
C	olive drab (low IR) *
S	special (call Tronair) *

* additional cost

These options will customize a hydraulic power unit to meet your requirements.
 See *previous page for option availability per model number.*

Option A – 25 ft (7.6 m) Hoses

Replaces standard 15 ft. (4.5 m) Note: Two (2) A's (AA) options may be required for a split system (Option C)

Option B – 50 ft (15.2 m) Hoses

Replaces standard 25 ft. (7.6 m) hose. Note: Two (2) B's (BB) options may be required for a split system (Option C)

Option C – Split System

Adds a second set of pressure and return hoses with shut off valves

Option D – Split System With Crossover Check

Simulate helicopter main system failure to test secondary system for correct operation

Option E – Hour Meter (50 Hz)

Adds monitor to help schedule filter changes and other maintenance functions

Option F – Hour Meter (60 Hz)

Adds monitor to help schedule filter changes and other maintenance functions

Option G – Voltage Monitor (200/230 Vac)

Adds a shut down feature in the event an incorrect input voltage, phase loss, incorrect phase sequence, low voltage, high voltage and or unbalanced voltage occurs

Option H – Voltage Monitor (380 Vac)

Same description as Option G

Option I – Voltage Monitor (415/460 Vac)

Same description as Option G

Option J – Voltage Monitor (575 Vac)

Same description as Option G

Option K – Pyrometer

Adds a temperature gauge to monitor return oil temperature

Option L – Electronic Reservoir Sensor

Adds a feature to power unit down if reservoir fluid level is either too high or too low. Includes panel warning lights

Option M – Hand Pump

Adds a 5,000 psi (345 bar) Hi/Lo hand pump, 2 micron filter & 10,000 psi (690 bar) pressure gauge to be used for reservoir service or component testing. Except on 51, 5B and 5C Series units, a 500 psi (34.5 bar) hand pump is added, no pressure gauge

Option N - Towing/Trailer Package

Adds rubber tires, leaf springs suspension, automatic brake and towbar for towing between hangers

Option P – Overflow Return Hose

Adds a reservoir return dump hose from aircraft reservoir to unit reservoir

Option Q – Calibration Port

Adds the capability to attach a test gauge to instrument panel to calibrate pressure gauge to rated capacity of the hydraulic unit

Option R – Electric Filter Clogging Indicator

Adds a sensor to detect pressure differential between filter input and output with a panel warning light to detect need for filter change

Option S – Over Temperature Shutoff Sensor

Adds sensor to the return system of the hydraulic unit to shut down before it over heats. Includes panel warning lights

Option T – Return Backpressure With Return Sight Glass

Controls return hose backpressure. Sight glass on addition return hose is included (For use with Citation aircraft where required)

Option U – Return Sight Glass

Adds a sight glass to monitor possible air in return line fluid

Option V – Return Backpressure Valve

Adds an adjustable backpressure valve that prevents aircraft reservoir from draining back to unit reservoir

Option W – Return Filter

Adds a 10 micron return filter to those units where it is not standard (Series 50 & 51 hydraulic units only)

Option X – Height Extension Unit

Used on series 50 hydraulic unit to raise controls to a more comfortable operating height

Option Y – Dual Return Sight Glass

For use with split system

Option Z – No Return Valves

For use with split system

Option 1 – Return Backpressure

For use with split system

Option 2 – Red Stack Light

Tower light with red LED bulb

Option 4 – Drip Pan

Stainless steel pan covering the bottom of the unit to eliminate possible fluid drips

Option 5 – Remote E-Stop

Hand held pendant with emergency stop button on a 50 ft. cord

Option 6 – Return Sight Gauge (Triple System)

Adds sight gauges to monitor possible air in return line fluid

Option 7 – Hand Pump (Large Displacement)

Adds a 200 psi (13.8 bar), 8 cu-in/stroke hand pump, 2 micron filter & 300 psi (20.7 bar) pressure gauge to be used for reservoir service.

Option 8 – Pressure Reducing Valve (Split System)

Adds the ability to adjust the pressure in both systems independently

It is the responsibility of the purchaser to specify CE compliance if required

Hydraulic Power Units - Quick Select Chart

MODEL BY FLUID TYPE

MIL-PRF-5606	MIL-PRF-83282	Skydrol/Hyjet	MIL-PRF-87257	Available Options
6 GPM (23 LPM) & 1,750 PSI (121 BAR), 3 HP, Series 50				Page 119
50101	50201	50301	N/A	A, C, D, F, K, P, T, W, X
N/A	5F201	N/A	N/A	A, F, K, W, X
6 GPM (23 LPM) & 3,000 PSI (207 BAR), 5 HP, Series 51				Page 119
51101	51201	51301	N/A	A, C, D, F, K, M, T, W
N/A	5B201	N/A	N/A	A, C, D, F, K, M, W
10 GPM (38 LPM) & 3,000 PSI (207 BAR), 15 HP, Series 52				Page 119
5211152200	52311	52411		A, B, C, D, E, F, G, H, I, J, K, L, M, N, Q, R, S, U, V, Y,
N/A	N/A	*5H310	N/A	T (Phosphate Ester ONLY)
11 GPM (42 LPM) & 5,000 PSI (345 BAR), 25 HP, Series 53				Page 119
53111	53211	53311	53411	B, C, D, E, F, G, H, I, J, K, L, M, N, Q, R, S, V, T (Phosphate Ester ONLY)
15 GPM (57 LPM) & 3,500 PSI (241 BAR), 25 HP, Series 54				Page 119
54111	54211	54311	54411	B, C, D, E, F, G, H, I, J, K, L, M, N, Q, R, S, U, V, Y, T (Phosphate Ester ONLY)
20 GPM (75.7 LPM) & 4,000 PSI (276 BAR), 30 HP, Series 5J				Page 119
5J111	5J211	5J311	5J411	B, C, D, E, F, G, H, I, J, K, L, M, Q, R, S, T (Phosphate Ester ONLY)
25 GPM (95 LPM) & 5,000 PSI (345 BAR), 75 HP, Series 55				Page 121
55111	55211	55311	55411	B, C, H, I, J, L, M, N
34 GPM (129 LPM) & 4,000 PSI (276 BAR), 40 HP, Series 56				Page 121
56111	56211	56311	56411	B, C, G, H, I, J, L, M, N, U, Y
34 GPM (129 LPM) & 4,000 PSI (276 BAR), 75 HP, Series 57				Page 121
57111	57211	57311	57411	B, C, H, I, J, L, M, N, U, Y
63 GPM (239 LPM) & 4,000 PSI (276 BAR), 100 HP, Series 58				Page 123
N/A	N/A	*58331	N/A	B, C, H, I, J, L, M, N
63 GPM (239 LPM) & 5,000 PSI (345 BAR), 150 HP, Series 59				Page 123
N/A	N/A	*59331	N/A	B, C, H, I, J, L, M, N
63 GPM (239 LPM) & 4,000 PSI (276 BAR), 150 HP, Series 5A				Page 123
N/A	N/A	*5A331	N/A	B, C, H, I, J, L, M, N
63 GPM (239 LPM) & 5,000 PSI (345 BAR), 150 HP, Series 5L				Page 123
N/A	N/A	*5L331	N/A	B, C, H, I, J, L, M, N

* Available with Soft Start, see ordering instructions on page 115

It is the responsibility of the purchaser to specify CE compliance if required

Standard Features:

- Cummins, QSB4.5P130, Tier 3, 130 HP, 1800 rpm diesel engine (Jet-A or diesel fuel)
- 69 gpm, 5000 psi, flow and pressure ratings
- Split system with 50' (15 m) pressure and return hoses, pressure and return couplings for both systems
- Hydraulic System Meters: Digital (0.1% FS) flow meter, digital (0.25% FS) pressure gauge, digital (0.5% FS) temperature gauge
- Engine System Monitor: Back lit digital display and diagnosis (DDD) with hour meter, and LED indicator lights
 - The Engine DDD is a multifunction tool, which displays many engine-operating parameters including oil pressure, oil temperature, RPM, running hours, coolant temperature and fuel consumption. For the technician, the DDD can display service reminders for filter replacements, active fault codes and stored service codes for easy engine maintenance and diagnostics
- Hydraulic Operation and Controls
 - Hydraulic system open or closed loop via four way selector valve
 - Pressure Control Valve
 - Flow Control Valve
 - Bypass Valve for loading and unloading the hydraulic pump
 - Hand Pump Gauge
 - Pressure Gauge Calibration Port
 - Calibration Port Shut Off Valve
 - Selector Valve to select between aircraft or HPU reservoir
- User friendly engine control panel for easy operation, includes service tool socket
- Pressure Filtration: 2 micron, non-bypass type (beta rating >200 @ 2 micron)
- Return Filtration: 5 micron, bypass type (beta rating > 300 @ 5 micron)
- 70 gallon stainless steel hydraulic reservoir with desiccant breather, drain valve, and air removal system
- Large forced air cooler (20+ HP heat removal) hydraulic heat exchanger, thermostat controlled cooling system
- 24 volt, dual battery for cold weather starts
- Engine block and grid heater cold weather system
- Reservoir Service/Component Testing: Manual two stage hand pump (high volume / 5000 psi) with 2 micron, non-bypass type (beta rating >200 @ 2 micron) pressure filter
- Convenient hangers and trays to hold and contain the hydraulic hoses when not in use on the aircraft
- Ruggedized frame with enclosed fork lift tubes and 10,000 lb tie down rings
- Running gear rated for 8500 lbs. and 10 mph, Four wheel Ackerman steering with leaf spring trailer towing system with two wheel parking brake
- Bright LED lighting on engine and hydraulic instrument panels, and unit corner lights for night operation
- Large 35 gallon fuel tank for 12+ hours of use
- Hydraulic fluid sample port for contamination testing
- Quiet Operation: Less than 85 dbA at three feet noise level
- Hydraulic high and low reservoir shutoff feature with LED warning and indicating lights (panel and stack)
- Hydraulic high temperature shutoff feature (160° F) with LED warning and indicating lights (panel and stack)
- Engine no fuel and low fuel, high temperature, and low oil pressure LED indicating lights (panel and stack)
- Lubricity and fuel/water separator with water-in-fuel (WIF) sensor
- Low coolant shut down system
- Pressure filter clogging indicator LED light with reset button
- Pressure gauge calibration port for (on unit) calibration with safety shut-off valve
- Emergency stop button, system pressure relief valve, maintenance only access panels, return system pressure relief valve, automatic warning and shutdown systems
- Fire extinguisher
- Easy access, light weight, removable pin hinged panels for full access to all maintenance components
- Corrosion resistant galvanized sheet metal and resistant stainless steel hardware
- CE Marked
- Powder coated (and Jet-Glo) Skydrol and UV resistant painted steel panels
- Finish: Durable Powder Coat Tronair Blue



Control Panel



Specifications:

Model Number	Fluid Type	Length in (cm)	Width in (cm)	Height in (cm)	Weight lb (kg)
673A	Skydrol, Hyjet	130.31 (331)	83.5 (212)	81.75 (207.6)	8500 (3856)
671A	MIL-PRF-5606	130.31 (331)	83.5 (212)	81.75 (207.6)	8500 (3856)

67 Series Performance Curve:

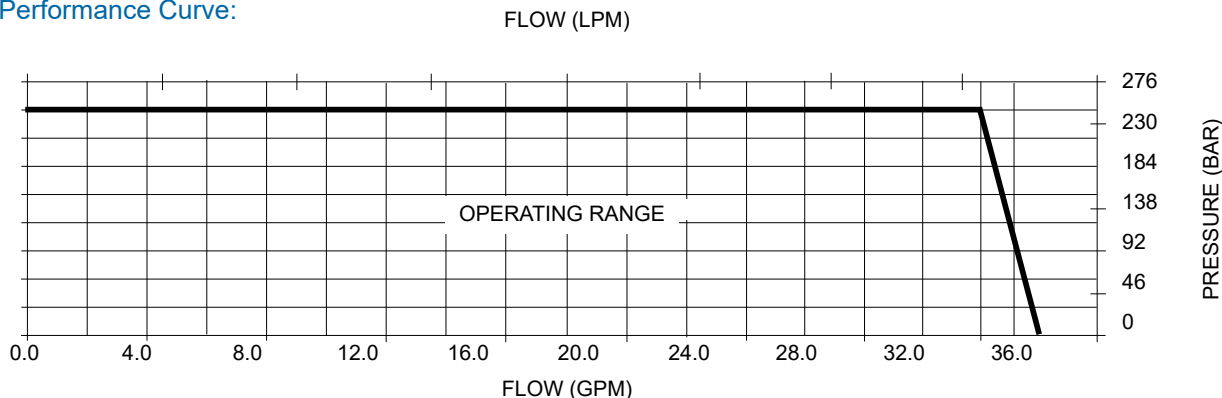

50 & 51 Series Hydraulic Power Units

Standard Features:

- 6 gpm (22.7 lpm) pressure compensated pump with adjustable flow and pressure controls
- Certified pressure gauge
- 0-10 gpm (0-38 lpm) dual scale flowmeter
- 2.4 gpm (9 lpm) flow at rated pressure
- Bypass valve
- Reservoir selector valve
- High efficiency, non-bypassing pressure filter with 2-micron absolute, Microglass III element (Beta rating > 2,000 based on ISO 4572)
- #8 pressure and #16 return hoses (PE), or #12 return hose (MB), 15 ft. (4.5 m) long with 37° female JIC swivel connectors
- Standard 50 ft. (15.2 m) input power cord
- Heavy duty 3 phase motor
- Heavy duty starter with overload protection and external manual reset button
- Sturdy welded steel frame with 16 gauge sheet metal cabinet
- Fluid sample valve
- Operating instruction located on instrument panel
- Two (2) fixed and two (2) swivel casters for easy maneuvering
- Finish: Durable Powder Coat Tronair Blue
- 50 Series ONLY:
 - Corrosion resistant 10 gal (37.9 l) reservoir
 - Removable lid for easy access
 - Push handle acts as hose hanger
- 51 Series ONLY:
 - Stainless steel 13 gal (49 l) reservoir
 - Heat exchanger with electric fan
 - Illuminated On/Off switch
 - Front access door panel for ease of maintenance

Available Options:

- Options:
 - 50 Series - A, C, D, F, K, P, T, W, X
 - 51 Series - A, C, D, F, K, M, T, W
 (see page 120 for option description)
- Input Voltage (Required) - (see page 121)
- Protective Cover
 - 50 Series - H-1338
 - 51 Series - H-1339
- Coupling Kits - (see pages 131 - 135)
- Unit Self Servicing Kit - Part Number K-3590 (MB) Part Number K-3591 (PE)



Specifications:

Series	Max Pressure psi (bar)	Max Gauge psi (bar)	Motor hp (kW)	Length in (cm)	Width in (cm)	Height in (cm)	Weight lb (kg)
50	1750 (121)	3000 (207)	3 (2.2)	48 (122)	30 (76)	37 (94) *	341 (155)
51	3000 (207)	5000 (345)	5 (3.7)	45 (114)	33 (84)	44 (111)	501 (227)

* Height with option X is 55 in (140 cm)

5J, 52, 53 & 54 Series Hydraulic Power Units

Standard Features:

- Adjustable working pressure
- 3 phase, electric motor available in 10 voltages (50 or 60 Hz)
- Adjustable pressure compensated, variable volume, piston pump
- 30 gal (114 l) stainless steel reservoir with desiccant air filtration canister
- Large fluid cooler with 3 phase electric fan (16,000 btu/hr cooling capacity)
- High efficiency, non-bypassing pressure filter with 2-micron absolute, Microglass III element (Beta rating > 1,000 based on ISO 4572)
- Large capacity return filter with 5 micron absolute, Microglass III element (Beta rating > 200 based on ISO 4572)
- Easy access fluid sampling valve (meets ANSI T2.24.1-1991)
- 1-15 gpm (4-56 lpm) dual scale flowmeter
- 2-25 gpm (7.6-95 lpm) 5J Series ONLY
- Dual scale pressure gauge
- Standard 25 ft (7.62 m) pressure and return hoses
- Standard 15 ft (4.57 m) 52 Series ONLY
- Standard 50 ft. (15.24 m) input power cord without input plug
- Finish: Durable Powder Coat Tronair Blue
- Dimensions:
 - Length: 54 in (137 cm)
 - Width: 51 in (130 cm)
 - Height: 50 in (127 cm)

Available Options:

- Options
 - 5J Series - B, C, D, E, F, G, H, I, J, K, L, M, N, Q, R, S, T
 - 52 Series - A, B, C, D, E, F, G, H, I, J, K, L, M, N, Q, R, S, T
 - 53 Series - B, C, D, E, F, G, H, I, J, K, L, M, N, Q, R, S, T
 - 54 Series - B, C, D, E, F, G, H, I, J, K, L, M, N, Q, R, S, T, U, V
 (see page 120 for option description)
- Input Voltage (Required) - (see page 121)
- Coupling Kits - (see pages 131 - 135)

Key for Performance Curves:

KEY: = 50 Hz
 = 60 Hz



Specifications:

Series	Rated Pressure psi (bar)	Motor hp (kW)	Rated Flow		Hose		Weight lb (kg)
			50 Hz gpm (lpm)	60 Hz gpm (lpm)	Pressure size	Return size	
5J	250-4000 (17-276)	30 (22)	16.7 (63)	20 (76)	12 (¾")	16 (1")	1650 (748)
52	750-3000 (52-207)	15 (11)	8.3 (31.4)	10 (37.8)	8 (½")	12 (¾")	1200 (544)
53	750-5000 (52-345)	25 (19)	9 (34.6)	11 (41.6)	8 (½")	16 (1")	1450 (658)
54	750-3500 (52-241)	25 (19)	12 (47.3)	15 (56.7)	12 (¾")	16 (1")	1450 (958)

5J Series:

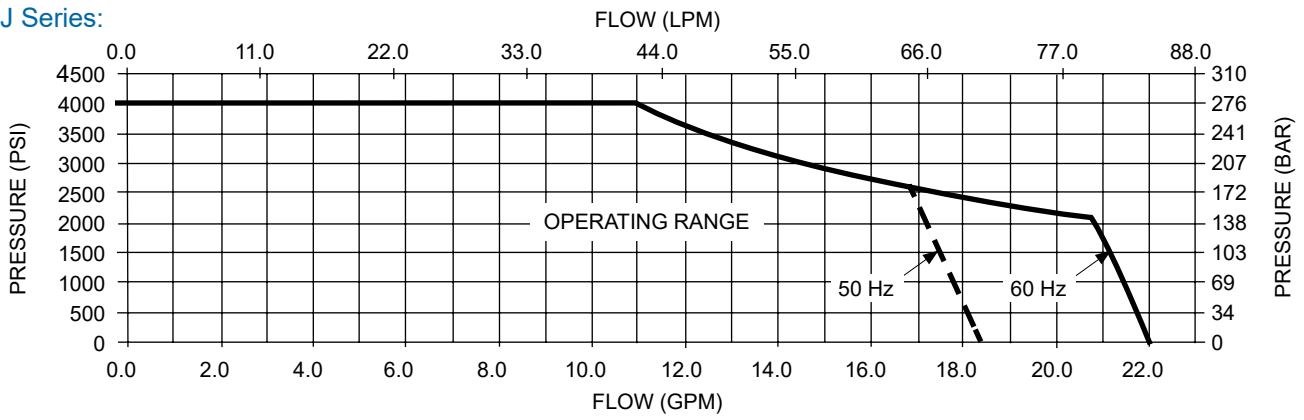

52 Series:

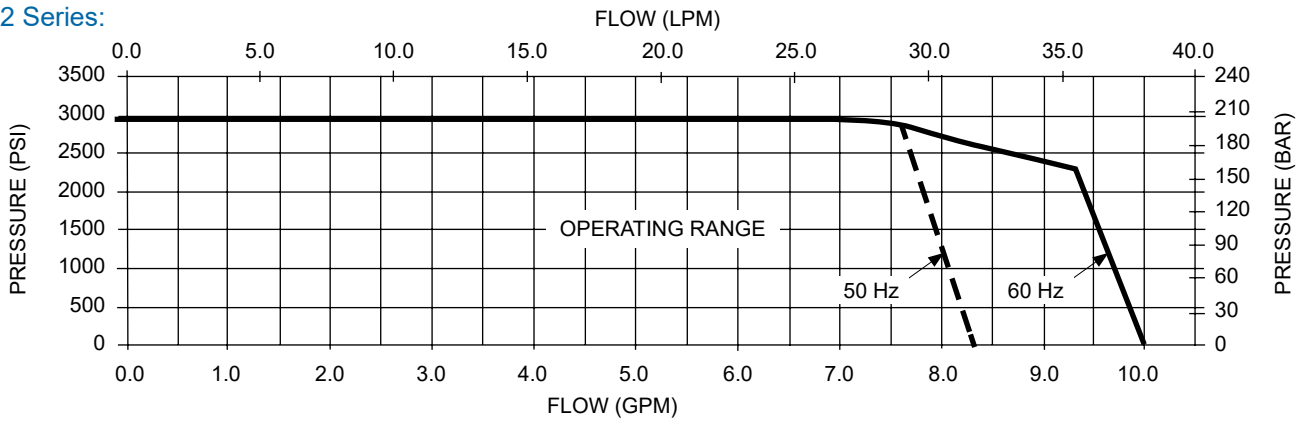

53 Series:

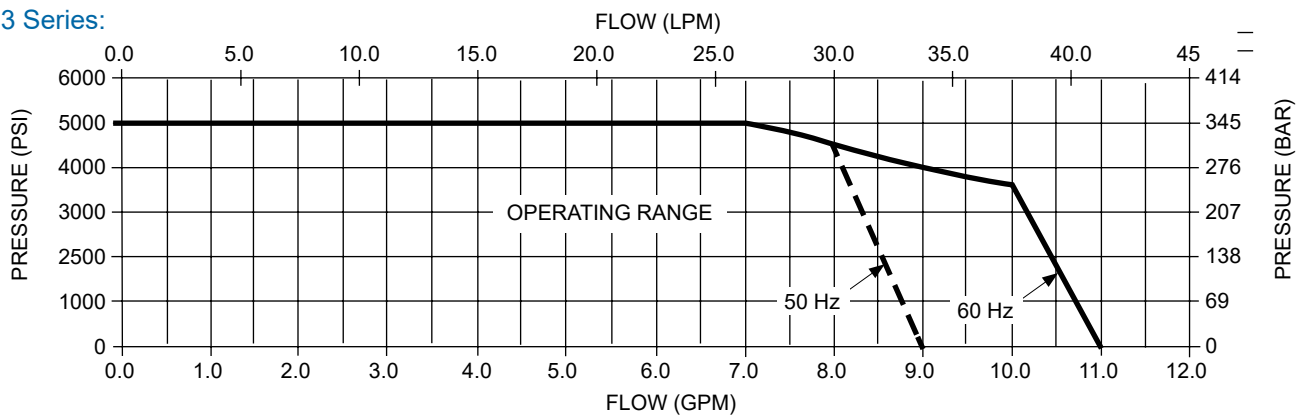

54 Series:

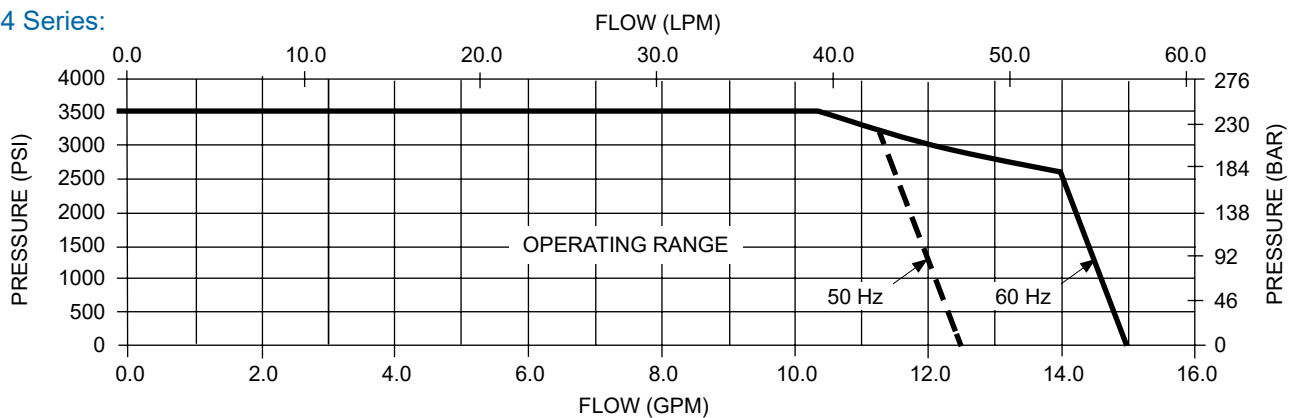

55, 56 & 57 Series Hydraulic Power Units

Standard Features:

- Adjustable working pressure
- 3 phase, electric motor available in 6 voltages (50 or 60 Hz)
- Adjustable pressure compensated, variable volume, piston pump
- 70 gal (265 l) stainless steel reservoir with desiccant air filtration canister
- Large fluid cooler with 3 phase electric fan(38,000 btu/hr cooling capacity)
- High efficiency, non-bypassing pressure filter with 2-micron absolute, Microglass III element (Beta rating > 200 based on ISO 4572)
- Large capacity return filter with 5 micron absolute, Microglass III element (Beta rating > 300 based on ISO 4572)
- Easy access fluid sampling valve (meets ANSI T2.24.1-1991)
- 2-48 gpm (8-180 lpm) dual scale flow meter
- Dual scale pressure gauge
- Standard 25 ft (7.62 m) pressure and return hoses
- Standard 50 ft. (15.24 m) input power cord without input plug
- High Fluid temperature (>160° F) shut off switch with LED indicator light
- -40 to 180° F (-40 to 80° C) dual scale pyrometer
- Hourmeter
- Galvannealed sheet metal to prevent corrosion
- Finish: Durable Powder Coat Tronair Blue

Dimensions:

- Length: 82 in (208 cm)
89 in (226 cm) with option N,
Towing Trailer package
- Width: 63.75 in (162 cm)
70.75 in (180 cm) with option C, Split System
- Height: 62 in (158 cm)
70.5 in (180 cm) with option N,
Towing Trailer package

Available Options:

- Options
55 Series - B, C, H, I, J, L, M, N
56 Series - B, C, G, H, I, J, L, M, N, U
57 Series - B, C, H, I, J, L, M, N, U, Y
(see page 120 for option description)
- Input Voltage (Required) - (see page 121)
- Coupling Kits - (see pages 131 - 135)



Key for Performance Curves:

KEY: = 50 Hz
 = 60 Hz



56 Series

Specifications:

Series	Rated Pressure psi (bar)	Motor hp (kW)	Rated Flow		Hose		Weight lb (kg)
			50 Hz gpm (lpm)	60 Hz gpm (lpm)	Pressure size	Return size	
55	250-5000 (17.2-345)	75 (56)	20 (78)	25 (94.6)	12 (¾")	20 (1 ¼")	3500 (1588)
56	250-4000 (17.2-276)	40 (30)	28 (107)	34 (129)	16 (1")	24 (1 ½")	3150 (1430)
57	250-4000 (17.2-276)	75 (56)	28 (107)	34 (129)	16 (1")	24 (1 ½")	3500 (1588)

55 Series:

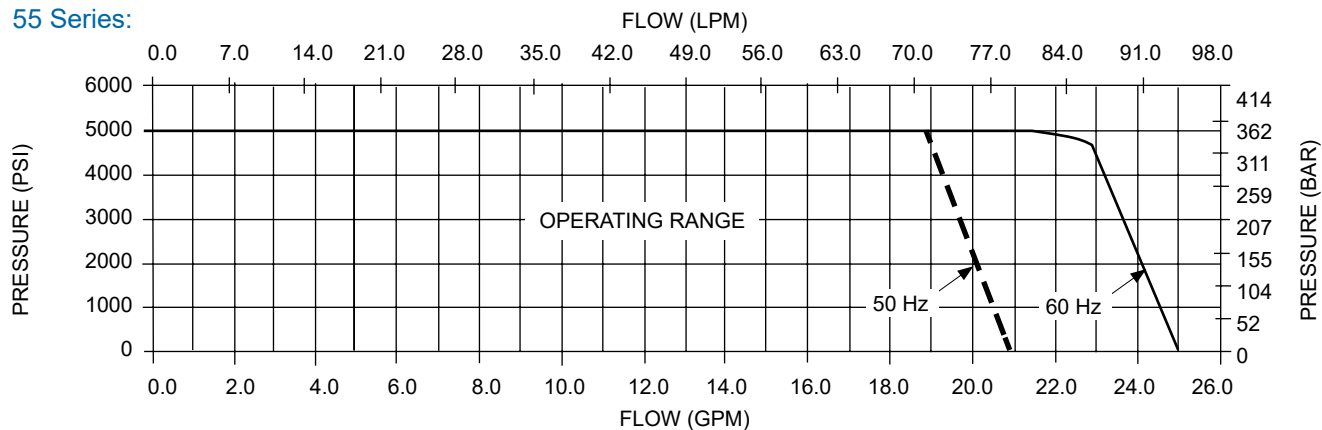

56 Series:

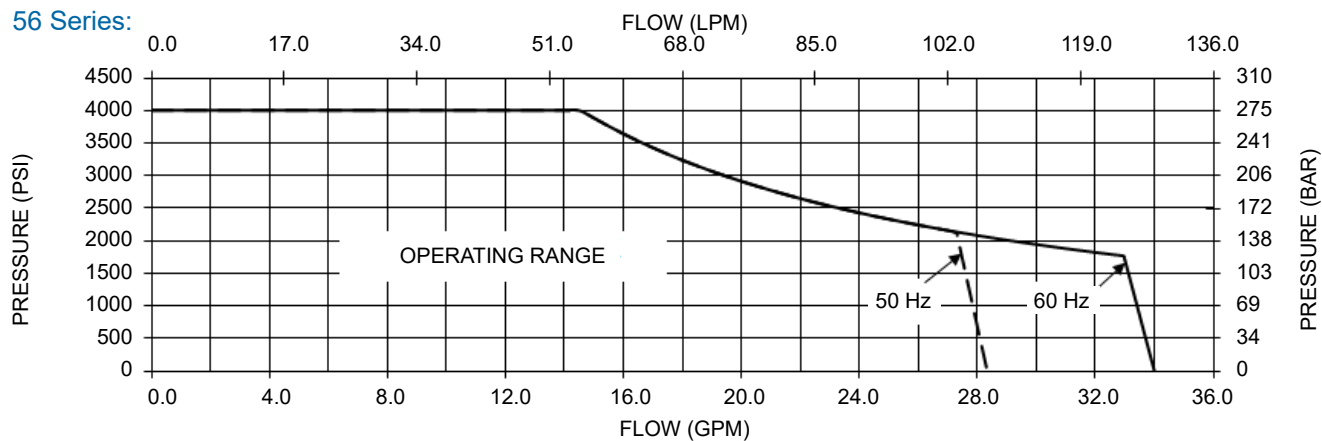

57 Series:

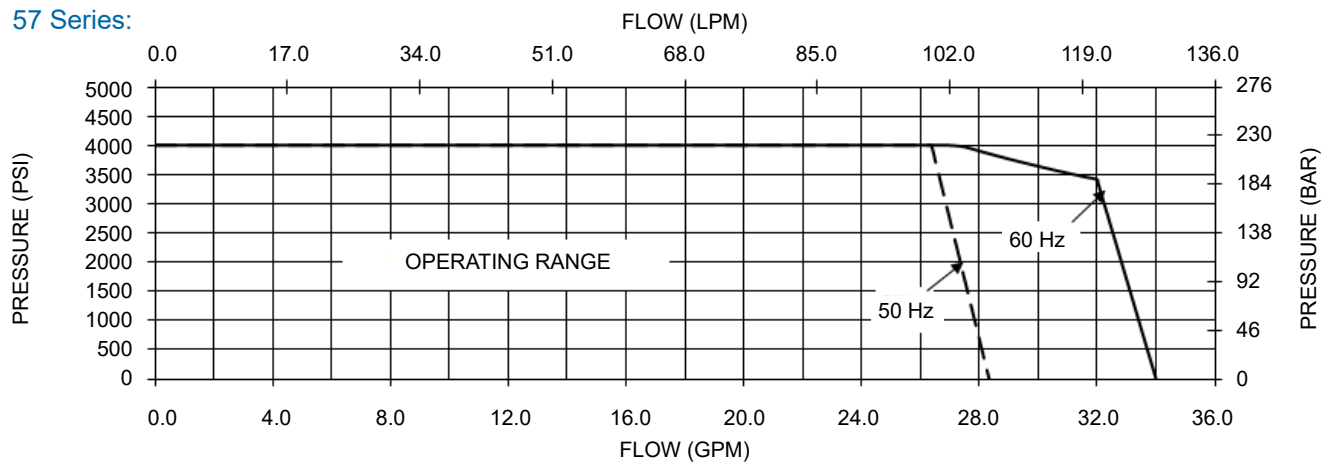

5A, 5L, 58 & 59 Series Hydraulic Power Units

Standard Features:

- Adjustable working pressure
- 3 phase, electric motor available in 6 voltages (50 or 60 Hz)
- Adjustable pressure compensated, variable volume, piston pump
- 150 gal (568 l) stainless steel reservoir with desiccant air filtration canister
- Large oil cooler with 3 phase electric fan (48,000 btu/hr cooling capacity)
- High efficiency, non-bypassing pressure filter with 2-micron absolute, Microglass III element (Beta rating > 400 based on ISO 4572)
- Large capacity return filter with 5 micron absolute, Microglass III element (Beta rating > 300 based on ISO 4572)
- Easy access fluid sampling valve (meets ANSI T2.24.1-1991)
- 2.5-80 gpm (10-300 lpm) dual scale flow meter
- Dual scale pressure gauge
- Standard 25 ft (7.62 m) pressure and return hoses
- Standard 50 ft. (15.24 m) input power cord without input plug
- High Fluid temperature (>160° F) shut off switch with LED indicator light
- -40 to 180° F (-40 to 80° C) dual scale pyrometer
- Hourmeter
- Electric Soft Start (optional)
- Galvannealed sheet metal to prevent corrosion
- Finish: Durable Powder Coat Tronair Blue

Dimensions:

- Length: 101 in (257 cm)
116 in (295 cm) with option N, Towing Trailer package
- Width: 82 in (208 cm)
89 in (226 cm) with option C, Split System
- Height: 62.5 in (159 cm)
71 in (181 cm) with option N,
Towing Trailer package

Available Options:

- Options - B, C, H, I, J, L, M, N
(see page 120 for option description)
- Input Voltage (Required) - (see page 121)
- Coupling Kits - (see pages 131 - 135)



Key for Performance Curves:

KEY: = 50 Hz
 = 60 Hz



58 Series

Specifications:

Series	Rated Pressure psi (bar)	Motor hp (kW)	Rated Flow		Hose		Weight lb (kg)
			50 Hz gpm (lpm)	60 Hz gpm (lpm)	Pressure size	Return size	
5A	250-4000 (17.2-276)	150 (112)	54 (205)	63 (239)	16 (1")	24 (1 1/2")	6500 (2948)
5L	250-5000 (17.2-345)	150 (112)	54 (205)	63 (239)	16 (1")	24 (1 1/2")	6500 (2948)
58	250-4000 (17.2-276)	100 (75)	54 (205)	63 (239)	16 (1")	24 (1 1/2")	6500 (2948)
59	250-5000 (17.2-345)	150 (112)	54 (205)	63 (239)	16 (1")	24 (1 1/2")	6500 (2948)

Special Purpose Hydraulic Power Units

Special Features:

- 5D10backpressure valve, aircraft and run around couplings
- 5F20reservoir overflow hose, return sight glass, no selector valve
- 5G31locking switch, high pressure return hoses and valves, white paint
- 5H31split system, 25 ft & 50 ft hoses, hourmeter, pyrometer, clogging indicator, aircraft couplings, spare filter element, no return valves

Specifications:

Series	Manufacturer/Aircraft	Fluid	Max Pressure psi (bar)	Max Flow gpm (lpm)	Flow at Rated Pressure gpm (lpm)	Motor hp (kW)	Weight lb (kg)
5D10	Raytheon JPATS	MIL-PRF-5606	3000 (207)	6 (23)	4.9 (18)	10 (7.5)	550 (249)
5F20	Cessna Citation Pkg. B	MIL-PRF-83282	1750 (121)	6 (23)	2.5 (9)	3 (2.2)	320 (145)
5G31	Gulfstream (factory)	Skydrol or Hyjet	3500 (241)	34 (129)	31.2 (118)	40 (30)	3500 (1588)
5H31	Bombardier Dash-8 100/300	Skydrol or Hyjet	3500 (241)	11 (42)	6.2 (24)	15 (11.2)	1200 (544)

5A Series:

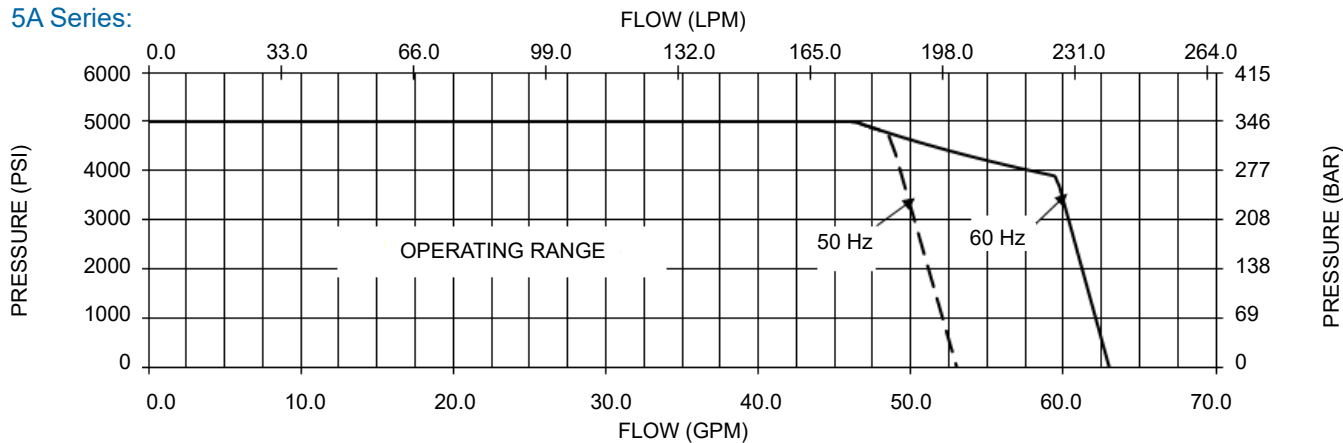

5L Series:

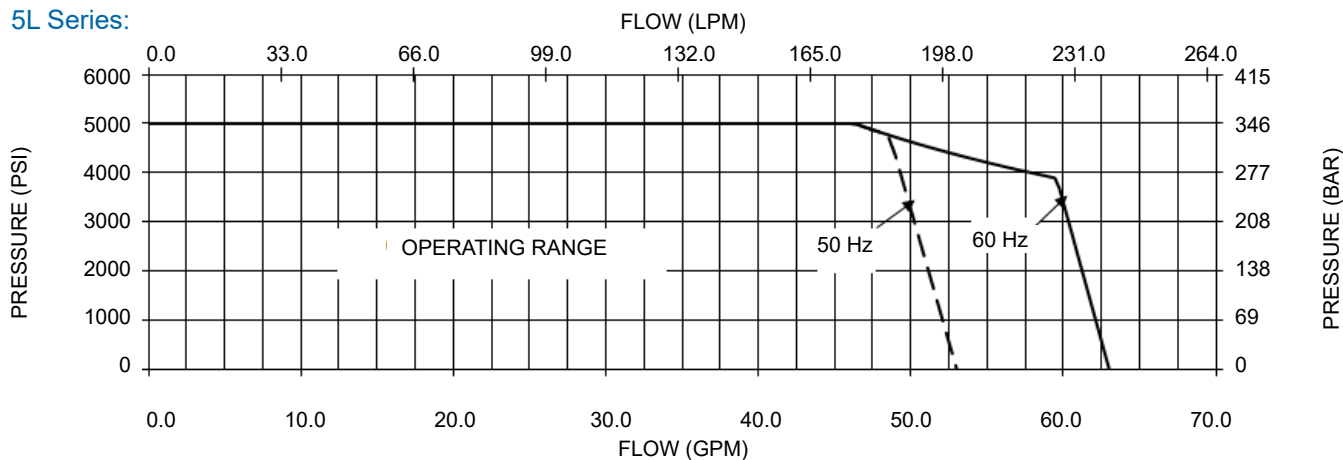

58 Series:

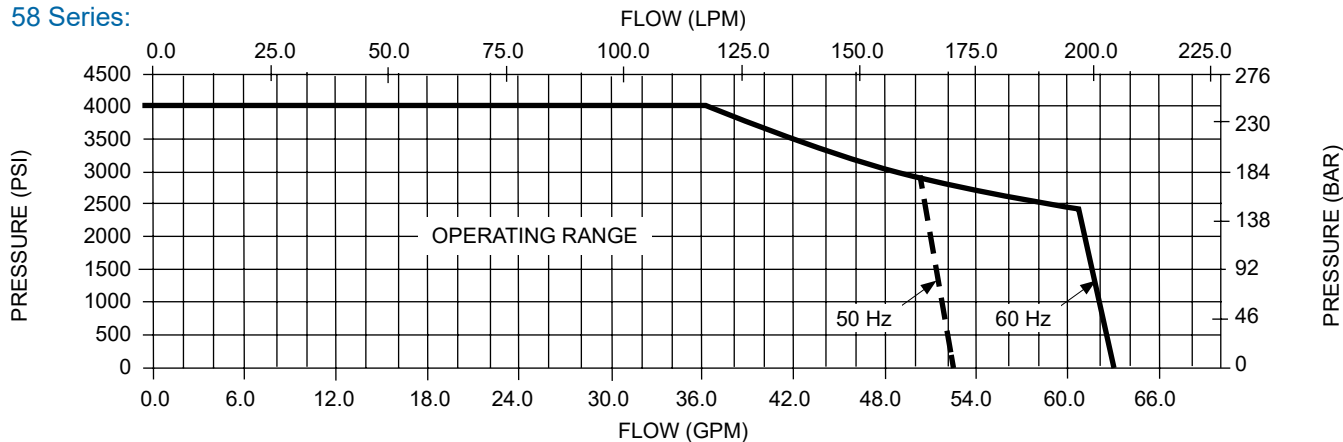

59 Series:

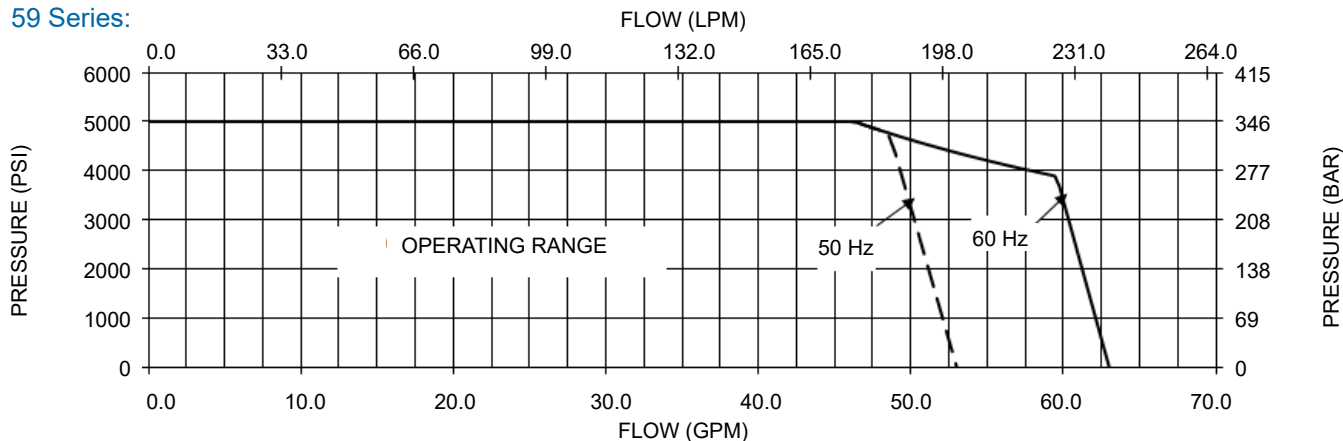

TAD Series True Dual Hydraulic Power Units

Standard Features:

- Adjustable working pressure, two independent systems
- 3 phase, softstart electric motor available in 6 voltages (50 or 60 Hz)
- Adjustable pressure compensated, variable volume, piston pump
- 90 gal (341 l) stainless steel reservoir with desiccant air filtration canister
- Two large fluid coolers with 3 phase electric fan
- Two high efficiency, non-bypassing pressure filters with 2-micron absolute, Microglass III element (Beta rating > 200 based on ISO 4572)
- Two large capacity return filters with 5 micron absolute, Microglass III element (Beta rating > 300 based on ISO 4572)
- Electric clogged filter indicator
- Easy access fluid sampling valves (meets ANSI T2.24.1-1991)
- Two 2-48 gpm (8-180 lpm) dual scale flow meter
- Two dual scale pressure gauge
- High Fluid temperature (>160° F) shut off switch with LED indicator light, each system
- Electric over temperature switch
- -40 to 180° F (-40 to 80° C) dual scale pyrometer, each system
- Hourmeter
- Electric reservoir fill system with 2-micron filter and coupling
- Electric high-low reservoir level
- LED backlit return sightgauges
- Quick disconnect hydraulic couplings
- Stainless steel drip pan
- Galvannealed sheet metal to prevent corrosion
- Standard 25 ft (7.62 m) pressure and return hoses, two sets
- Standard 50 ft. (15.24 m) input power cord without input plug
- Hose trays and hangers
- Forklift tubes
- Dimensions: Length: 76 in (193 cm)
Width: 90 in (229 cm)
Height: 58 in (147 cm)
69 in (175 cm) with option N, Towing Trailer package
- Finish: Durable Powder Coat

Additional Standard Features: TADHPU-5FJ

- Third pressure and return line
- Active moisture degassing system
- Electric reservoir service pump, remote pendant control



Specifications:

Series	Rated Pressure psi (bar) each system	Motor hp (kW)	Rated Flow		System 1 Hose		System 2 Hose		Weight lb (kg)
			System 1 gpm (lpm)	System 2 gpm (lpm)	Pressure size	Return size	Pressure size	Return size	
TADHPU-5AN	250-3000 (17.2-207)	60 (45)	34 (129)	20 (76)	16 (1")	24 (1 1/2")	12 (3/4")	16 (1")	5000 (2268)
TADHPU-5GS	250-3000 (17.2-207)	60 (45)	34 (129)	20 (76)	16 (1")	24 (1 1/2")	12 (3/4")	16 (1")	5000 (2268)
TADHPU-5FS	250-4000 (17.2-276)	75 (56)	34 (129)	20 (76)	16 (1")	24 (1 1/2")	12 (3/4")	16 (1")	5000 (2268)

TAD True Dual Hydraulic Power Unit - Ordering Instructions

BASE UNIT

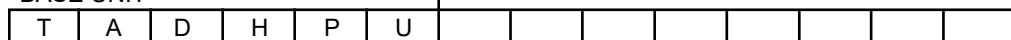

char	description
5GS	Gulfstream G500, G650, G650/G650ER, G700
5FJ	Falcon Jet 7X, 8X

char	description
N	towing/trailer package option
0	NO towing/trailer package option

char	description
1	KHC self circulation option (2 sets)
0	NO KHC self circulation kit option

char	description
1	contamination monitor option
0	NO contamination monitor option

char	voltage/freq/3 phase/soft start	input cord
15	480V/60Hz	50 ft (15.2 m) input cord length
16	380V/60Hz	
17	380V/50Hz, 415V/50Hz, 440V/50Hz	
18	575V/60Hz	
23	480V/60Hz	100 ft (30.5 m) input cord length
24	380V/60Hz	
25	380V/50Hz, 415V/50Hz, 440V/50Hz	
26	575V/60Hz	

Gasoline Engine Driven Hydraulic Power Units

Standard Features:

- 18 HP (13KW), Tier II, 2 cylinder gasoline engine
- 6 gpm (22.7 lpm) pressure compensated pump
- 2 micron pressure, 5 micron return filters
- Electric start, hour meter, tachometer
- Motor spark arrestor
- Oil and hydraulic fluid coolers
- Reservoir selector valve
- 6 gal (22.7 l) 5 hour fuel tank
- Dual scale flowmeter and pressure gauge
- High oil temperature switch
- Low oil pressure shut-down
- 2.6 qt (2.5 l) oil sump
- 370 cold cranking amp batteries (0°F)
- Reservoir level sight gauge
- Sturdy welded steel frame
- Trailer towbar and locking brake
- 30 ft (9 m) pressure and return hoses
- Finish: Durable Powder Coat Tronair Blue



Specifications:

Series	Fluid	Max Pressure psi (bar)	Max Gauge gpm (lpm)	Motor hp (kW)	Length in (cm)	Width in (cm)	Height in (cm)	Weight lb (kg)
50111ZZG	MIL-PRF-5606	1500 (103)	3000 (207)	18 (13)	76 (194)	64 (163)	46 (117)	1150 (522)

Compact Hydraulic Power Units

Standard Features:

- Portable, compact unit that easily adapts to mobile use
- 1500 psi capable
- Easy to use
- Increase aircraft component life, reduce aircraft filter changes
- 3/4 HP electric motor uses single phase power
- Bypass (dump) valve allows starting and stopping of the unit under a no-load, safe condition
- Best filtration in the industry, every unit is cleanliness certified
- High efficiency, non-bypassing pressure filter with 2-micron absolute, Microglass III element
- NIST calibrated pressure gauge
- Zero leak, no pipe thread design
- Models for every fluid type
- Hoses and power cord are stored neatly in the compact rugged unit
- Fold down handle makes moving the unit effortless
- Finish: Durable Powder Coat Tronair Blue



5Z211ZZF

Specifications:

Model Number	Max Flow gpm (lpm)	Electrical V/Hz/PH	Length in (cm)	Width in (cm)	Height in (cm)	Weight lb (kg)
5Z211ZZF	3/4 (2.84)	120/60/1	32 (81)	15 (38)	15 (38)	80 (36)

Hydraulic Coupling Hose Adaptor Kits



HYDRAULIC PRESSURE & RETURN COUPLING KITS

The kits contain couplings and dust plugs to adapt a hose to a specific aircraft bulkhead coupling.

Specifications: See *Hydraulic Power Order Instructions, Step #5 for HPU Coupling Designation (pg 115)*

Kit Number	HPU Coupling Designation		Manufacturer/Aircraft
	Single	Dual	
KHC-1004	AA	EA	BAe Jetstream 31/41 / Boeing Apache AH-64 / Bombardier Learjet (except 45) / Nihon YS-11 Raytheon Beechjet, Diamond, Premier / Sikorsky S-70, S-70L, S-76, Blackhawk
KHC-1005	AB	EB	BAe ATP / Bombardier Canadair CL-215, CL-215T, CL-415, deHavilland Buffalo Bell 204, 205, 206, 206B3, 206L, 206LT, 206L4, 212, 214B, 214ST, 222, 230, 241, 412, 427, 430 Dassault Falcon Jet (all) / Eurocopter AS 330 / Lockheed Jetstar / Pilatus PC-12 Raytheon HS-125 400-800 / Hawker 1000 / Sabreliner(all) / Sikorsky S-61, S-65
KHC-1006	AC	EC	Dornier Fairchild Merlin/Metroliner III & IV
KHC-1007	AD	ED	Gulfstream GI
KHC-1008	AE	EE	BAe 146 , RJ70, RJ85 / Cessna Citation X, 750 / Fokker F-28 / Gulfstream GII-GV, G400, G500, G550, G600, G650
KHC-1009	AG	EG	Boeing DC-9, MD-80 / Gulfstream GII-GIV / Lockheed L-1011
KHC-1010	AH	EH	Cessna Citation I, II, V, SII, Bravo 500/501/550, Excel 560XL, Ultra, Ultra Encore 560
KHC-1011	AI	EI	Bombardier Challenger 300, 600-604, CRJ-100/200/700/900
KHC-1011-M	---	EI	Bombardier Challenger 300, 600-604, CRJ-100/200/700/900
KHC-1012	AJ	EJ	Bombardier Canadair Challenger, RJ-100, deHavilland Dash-88 100 & 300, Global Express
KHC-1012-M	---	EJ	Bombardier Canadair Challenger, RJ-100, deHavilland Dash-88 100 & 300, Global Express
KHC-1012-A1	AK	EK	Bombardier deHavilland Dash-7
KHC-1013	AL	EL	Bombardier deHavilland Dash-7
KHC-1014	AM	EM	Airbus All / Bombardier deHavilland Dash-7
KHC-1015	AN	EN	Embraer EMB-110, 120, 121, ALX, MD900 / Sino Swearingen SJ30-2
KHC-1017	AP	EP	IAI Westwind 1 & 2
KHC-1020	AQ	EQ	Sikorsky S-76 (flareless connectors)
KHC-1022	CH	GH	Lockheed C130, Grumman Tracker
KHC-1038	AR	ER	Cessna 150, 152, 172, 177, 180, 182, 185, 206, 207, 210, 310, 320, 337 Skymaster, 340, 411, 414, 421 Gulfstream Aero Commander, Turbo Commander Piper Aerostar, Aztec, Cherokee, Chieftan, Chyenne II & III, Comanche, Navajo, Seneca
KHC-1042	AT	ET	Cessna Citation III, VI, VII, 650
KHC-1046	AU	EU	Sikorsky S-76, Saab 340
KHC-1075	AV	EV	Eurocopter BO-105, BK-117
KHC-1081	AW	EW	Fokker F28, F100
KHC-1084	AX	EX	Augusta A109A, Mark II
KHC-1089	AY	EY	BAe 146
KHC-1139	BA	FA	Lear 55
KHC-1151	BB	FB	Boeing DC-9, MD-80 (<i>series with one coupling</i>)
KHC-1160	BC	FC	BAe BAC 1-11, Fokker 70, 100 Boeing 707, 737-100 to 900, BBJ, BBJ2, DC-8, DC-9 (<i>10-50 series with two couplings</i>), MD-80
KHC-1230	BD	FD	Shorts 330, 360
KHC-1284	BE	FE	ATR 42, 72
KHC-1306	BF	FF	Dauphin SA 365N, EC, 155
KHC-1339	BG	FG	Dassault/Falcon 900
KHC-1342	BH	FH	Bombardier Global Express / Gulfstream G100 (Astra), G200 (Galaxy), G150 / DeHavilland
KHC-1468	BJ	FJ	Airbus All / Boeing 747, 757, 767, 777, DC-9, MD-80 Lockheed L-1011 / McDonnell Douglas DC-10, MD-11



HYDRAULIC PRESSURE & RETURN COUPLING KITS

The kits contain couplings and dust plugs to adapt a hose to a specific aircraft bulkhead coupling.

Specifications: See *Hydraulic Power Order Instructions, Step #5 for HPU Coupling Designation (pg 115)*

Kit Number	HPU Coupling Designation		Manufacturer/Aircraft
	Single	Dual	
KHC-1678	BK	FK	Fokker 50
KHC-1858	BL	FL	Casa CN-235, CN-295
KHC-2014	BM	FM	Boeing 737, 727-100 & 200
KHC-2078	BN	FN	Boeing 727-100/200
KHC-2199	BQ	FQ	Cessna Citation Jet525, 525A, CJ1, CJ2, CJ3
KHC-2257	BR	FR	Augusta A109A, A109C, A109E, Mark II
KHC-2280	CP	GP	Saab 2000
KHC-2407	BV	FV	Bombardier Learjet 45
KHC-2628	BY	FY	Embraer ERJ-135/145
KHC-2675	BZ	FZ	Raytheon JPATS
KHC-2738	CN	GN	Dornier 328, 328 Jet, Envoy 3 / Embraer Phenom 100
KHC-3559	CQ	GQ	Embraer ERJ 170/190 -- (Parker)
KHC-3561	CM	GM	Embraer ERJ 170/190 -- (Aeroquip)
KHC-3744	CD	GD	Boeing CH-47/MH-47, Chinook
KHC-3747	CE	GE	Boeing 717 / Embraer ERJ 170/190 (ADG Test Only)
KHC-3754	CG	GG	Bombardier deHavilland Dash-8-100/300/400
KHC-3766	CJ	GJ	Cessna Sovereign 680
KHC-3827	CS	GS	Sikorsky S-92
KHC-4000	CT	GT	Agusta AB139
KHC-4005	---	KG	Sukhoi SJ100
KHC-4051	CZ	KS	Lear 85
KHC-4026	CX	GU	HondaJet
KHC-4111	LR	---	Bombardier Global 7500, 8000
---	ZZ	ZZ	No Coupling

NOTE: If your aircraft is not listed contract Tronair

Hydraulic Coupling Hose Adaptor Kits

MULTIPLE AIRCRAFT HYDRAULIC PRESSURE & RETURN COUPLING KITS

The kits contain couplings and dust plugs to adapt a hose to a specific aircraft bulkhead coupling.

Specifications: See *Hydraulic Power Order Instructions, Step #5 for HPU Coupling Designation (pg 115)*

HPU Coupling Designation	Kit Number (qty)	Manufacturer/Aircraft
JA	KHC-1008 (1)	BAe 146 / Cessna Citation X / Fokker F-28 / Gulfstream GII-GV, G400, G500, G550
	KHC-1038 (1)	Cessna, Piper
JB	KHC-1008 (1)	BAe 146 / Cessna Citation X / Fokker F-28 / Gulfstream GII-GV, G400, G500, G550
	KHC-1009 (1)	Boeing DC-9, MD-80 / Gulfstream GII-GV / Lockheed L-1011
JC	KHC-1005 (1)	BAE ATP / Bell 204, 205, 206L, 206LI, 214B, 222, 212, 412, 214ST Bombardier CL215 thru CL415, deHavilland Buffalo / Dassault/Falcon FalconJet / Eurocopter AS 330 Hawker Beechcraft HS125 / Lockheed Jetstar / Pilatus PC12 / Saberliner / Sikorsky S-61, S-70
	KHC-1339 (1)	Dassault/Falcon 900
JD	KHC-1005 (1)	BAE ATP / Bell 204, 205, 206L, 206LI, 214B, 222, 212, 412, 214ST Bombardier CL215 thru CL415, deHavilland Buffalo / Dassault/Falcon FalconJet / Eurocopter AS 330 Hawker Beechcraft HS125 / Lockheed Jetstar / Pilatus PC12 / Saberliner / Sikorsky S-61, S-70
	KHC-1038 (1)	Cessna / Piper
JE	KHC-2407 (1)	Bombardier Learjet 45
	KHC-2424 (1)	Bombardier Learjet 45 (Reservoir)
JF	KHC-1017 (1)	IAI Westwind
	KHC-1342 (1)	Bombardier Canadair, Global Express / IAI Astra
JG	KHC-1005 (1)	BAE ATP / Bell 204, 205, 206L, 206LI, 214B, 222, 212, 412, 214ST Bombardier CL215 thru CL415, deHavilland Buffalo / Dassault/Falcon FalconJet / Eurocopter AS 330 Hawker Beechcraft HS125 / Lockheed Jetstar / Pilatus PC12 / Saberliner / Sikorsky S-61, S-70
	KHC-1020 (1)	Sikorsky S-76
JH	KHC-1008 (2)	BAe 146 / Cessna Citation X / Fokker F-28 / Gulfstream GII-GV, G400, G500, G550
	KHC-1009 (1)	Boeing DC-9, MD-80 / Gulfstream GII-GV / Lockheed L-1011
JI	KHC-1005 (2)	BAE ATP / Bell 204, 205, 206L, 206LI, 214B, 222, 212, 412, 214ST Bombardier CL215 thru CL415, deHavilland Buffalo / Dassault/Falcon FalconJet / Eurocopter AS 330 Hawker Beechcraft HS125 / Lockheed Jetstar / Pilatus PC12 / Saberliner / Sikorsky S-61, S-70
	KHC-1339 (1)	Dassault/Falcon 900
JJ	KHC-1005 (1)	BAE ATP / Bell 204, 205, 206L, 206LI, 214B, 222, 212, 412, 214ST Bombardier CL215 thru CL415, deHavilland Buffalo / Dassault/Falcon FalconJet / Eurocopter AS 330 Hawker Beechcraft HS125 / Lockheed Jetstar / Pilatus PC12 / Saberliner / Sikorsky S-61, S-70
	KHC-2407 (1)	Bombardier Learjet 45
JK	KHC-1004 (1)	BAe Jetstream 30 & 41 / Bombardier Learjet / Hawker Beechcraft Beechjet, Diamond / Nihon YS-11 Sikorsky Blackhawk, S-76
	KHC-1005 (1)	BAE ATP / Bell 204, 205, 206L, 206LI, 214B, 222, 212, 412, 214ST Bombardier CL215 thru CL415, deHavilland Buffalo / Dassault/Falcon FalconJet / Eurocopter AS 330 Hawker Beechcraft HS125 / Lockheed Jetstar / Pilatus PC12 / Saberliner / Sikorsky S-61, S-70
JL	KHC-1005 (1)	BAE ATP / Bell 204, 205, 206L, 206LI, 214B, 222, 212, 412, 214ST Bombardier CL215 thru CL415, deHavilland Buffalo / Dassault/Falcon FalconJet / Eurocopter AS 330 Hawker Beechcraft HS125 / Lockheed Jetstar / Pilatus PC12 / Saberliner / Sikorsky S-61, S-70
	KHC-2199 (1)	Cessna CitationJet 525
JM	KHC-1075 (1)	Eurocopter BK-117, BO-105
	KHC-1306 (1)	Eurocopter Dauphin SA 365N
JN	KHC-1015 (1)	Embraer EMB-110, EMB-120, EMB-314 (ALX)
	KHC-1038 (1)	Cessna / Piper
JP	KHC-1042 (1)	Cessna Citation III, VI, VII
	KHC-2199 (1)	Cessna CitationJet 525
JQ	KHC-1084 (1)	Agusta A109A / IAI Mark II
	KHC-2257 (1)	Agusta A109C
JR	KHC-1160 (1)	BAC I-II / Boeing 737-200 & 300, DC-8, DC-9 (10-50 series with two couplings), MD-80
	KHC-2078 (1)	Boeing 727-100 & 200
JS	KHC-1014 (1)	Airbus All / Bombardier deHavilland Dash-7
	KHC-1468 (1)	Airbus All / Boeing 747, 757, 767, DC-10 / Lockheed L-1011
	KHC-2258 (1)	Airbus All / Boeing 757, 767, DC-9, DC-10, MD, 11, MD-80 / Lockheed L-1011 (CSD Overflow)

MULTIPLE AIRCRAFT HYDRAULIC PRESSURE & RETURN COUPLING KITS

The kits contain couplings and dust plugs to adapt a hose to a specific aircraft bulkhead coupling.

Specifications: See *Hydraulic Power Order Instructions, Step #5 for HPU Coupling Designation (pg 115)*

HPU Coupling Designation	Kit Number (qty)	Manufacturer/Aircraft
JT	KHC-1005 (1)	BAE ATP / Bell 204, 205, 206L, 206LI, 214B, 222, 212, 412, 214ST Bombardier CL215 thru CL415, deHavilland Buffalo / Dassault/Falcon FalconJet / Eurocopter AS 330 Hawker Beechcraft HS125 / Lockheed Jetstar / Pilatus PC12 / Saberliner / Sikorsky S-61, S-70
	KHC-1075 (1)	Eurocopter BK-117, BO-105
JU	KHC-1005 (1)	BAE ATP / Bell 204, 205, 206L, 206LI, 214B, 222, 212, 412, 214ST Bombardier CL215 thru CL415, deHavilland Buffalo / Dassault/Falcon FalconJet / Eurocopter AS 330 Hawker Beechcraft HS125 / Lockheed Jetstar / Pilatus PC12 / Saberliner / Sikorsky S-61, S-70
	KHC-2257 (1)	Agusta A109C
JV	KHC-1005 (1)	BAE ATP / Bell 204, 205, 206L, 206LI, 214B, 222, 212, 412, 214ST Bombardier CL215 thru CL415, deHavilland Buffalo / Dassault/Falcon FalconJet / Eurocopter AS 330 Hawker Beechcraft HS125 / Lockheed Jetstar / Pilatus PC12 / Saberliner / Sikorsky S-61, S-70
	KHC-1306 (1)	Eurocopter Dauphin SA 365N
JX	KHC-1468 (1)	Airbus All / Boeing 747, 757, 767, DC-10 / Lockheed L-1011
	KHC-2078 (1)	Boeing 727-100 & 200
JY	KHC-3561 (1)	Embraer ERJ 170/190
	KHC-1342 (1)	IAI Astra / Bombardier Canadair Global Express / Gulfstream G200
JZ	KHC-1004 (1)	BAe Jetstream 30 & 41 / Bombardier Learjet / Hawker Beechcraft Beechjet, Diamond / Nihon YS-11 Sikorsky Blackhawk, S-76
	KHC-2407 (1)	Bombardier Learjet 45
KA	KHC-3559 (1)	Embraer ERJ 170/190
	KHC-3747 (1)	Boeing 717 / Embraer 170 & 190 (ADG test ONLY)
KB	KHC-1160 (1)	BAC I-II / Boeing 737-200 & 300, DC-8, DC-9 (10-50 series with two couplings), MD-80
	KHC-1468 (1)	Airbus All / Boeing 747, 757, 767, DC-10 / Lockheed L-1011
KC	KHC-4000 (1)	Agusta/Bell AB139
	KHC-4001 (1)	Agusta/Bell AB139 (Reservoir)
KD	KHC-1160 (1)	BAC I-II / Boeing 737-200 & 300, DC-8, DC-9 (10-50 series with two couplings), MD-80
	KHC-1342 (1)	IAI Astra / Bombardier Canadair Global Express / Gulfstream G200

Hydraulic Coupling Hose Adaptor Kits

HYDRAULIC RESERVOIR FILL COUPLING KITS

Specifications:

Kit Number	Manufacturer/Aircraft
KHC-1009	Boeing 747, DC-9 10/20/30/33/40/50, MD-80 Gulfstream GII, GIII, GIV, GV, G300 (G3), G400 (G4), G500 (G5)
KHC-1012	Bombardier Candair Challenger, CRJ 100/200 Bombardier DeHavilland Dash-8-100/300, Global Express
KHC-1012-M	Bombardier Candair Challenger, CRJ 100/200 Bombardier DeHavilland Dash-8-100/300, Global Express
KHC-1014	Airbus All Bombardier DeHavilland Dash-7
KHC-1046	Saab 340 Sikorsky S-76
KHC-1081	Fokker F-28, F-100
KHC-1089	BAe 146
KHC-1107	Cessna Citation III, VI, VII
KHC-1139	Bombardier Lear 55, 60
KHC-1339	Dassault Falcon 50, 900, 2000

Kit Number	Manufacturer/Aircraft
KHC-2014	Boeing 727-100/200, 737
KHC-2259	Boeing DC-8
KHC-2424	Bombardier Lear 45
KHC-3558	Embraer ERJ 170/190 (Parker) Sukohi SJ100
KHC-3560	Embraer ERJ 170/190 (Aeroquip)
KHC-3651	Embraer ERJ-135/145
KHC-3748	Boeing 717
KHC-3779	Cessna Sovereign 680
KHC-4001	Agusta AB139
KHC-4007	Hawker Beechcraft Hawker 4000 (Horizon)
KHC-4012	Cessna Citation X, 750
KHC-4017	Embraer Phenom 100
KHC-4027	HondaJet HF-120
KHC-4050	Lear 85

HYDRAULIC CSD FILL & ENGINE OIL KITS

Specifications:

Kit Number	Manufacturer/Aircraft
KHC-2046	Northrup E2C Hawkeye
KHC-2173	Airbus A300 Boeing 707, 727, 737, 747, 757, 777, DC-8, DC-9, MD-80 Bombardier Challenger, CRJ 100/200, Global Express Lockheed L-1011 McDonnell Douglas DC-10, MD-11

HYDRAULIC CSD OVERFLOW KIT

Specifications:

Kit Number	Manufacturer/Aircraft
KHC-2258	Airbus All Boeing 57, 767, DC-9, MD-80 McDonnell Douglas DC-10, MD-11

HPU SELF CLEANING CIRCULATION KITS

Standard Features:

- Ensure added flight safety by delivering clean hydraulic fluid to your aircraft!
- Kit connects pressure and return hoses together to circulate hydraulic fluid through the HPU's internal 2 and 5 micron filters for self cleaning
- Easy, drip proof port to connect hoses when not in use
- For single HPU systems (kits denoted by *are for true dual HPU systems)

Specifications:

Kit Number	Fluid	Use With Coupling Kit
KHC-4006	PE	KHC-4005
KHC-4022	PE	KHC-3754
KHC-4023	PE	KHC-1011
KHC-4024	PE	KHC-1342
KHC-4025	PE	KHC-1008-A1
KHC-4028	PE	KHC-1008
KHC-4029	PE	KHC-1160
KHC-4030	PE	KHC-3561
*KHC-4075	PE	KHC-1008

Kit Number	Fluid	Use With Coupling Kit
KHC-4002	MB	KHC-2257
KHC-4008	MB	KHC-4000
KHC-4020	MB	KHC-1004/KHC-1005
KHC-4021	MB	KHC-3766
KHC-4031	MB	KHC-2199
KHC-4033	MB	KHC-3827
KHC-4067	MB	KHC-4026
*KHC-4091	MB	KHC-1004/KHC-1005
*KHC-4092	MB	KHC-1004/KHC-1005

(kits denoted by *are for true dual HPU systems)

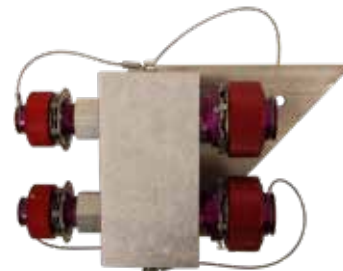

KHC-4006



KHC-4028

Standard Features:

- 6 particle range
- Laser light
- Units for mineral and phosphate ester fluids
- Alpha numeric note entry
- Stores last 300 tests and downloads to computer
- Compliant with ISO 11171
- Report format ISO 4406-1999 and correlation to NAS 1638
- 41° F (5° C) to 176° F (80° C) operating temperature
- Calibration certification included
- 6,000 psi (414 bar) pressure
- Viscosity to 465 SUS (100 cSt) with single point sampler
- Carrying case
- RS232 communication port
- Dimensions:
 - Length: 6 in (15 cm)
 - Width: 10 in (25 cm)
 - Height: 10 in (25 cm)
 - Weight: 18 lb (8 kg)
 - 29 lb (13 kg) with case

In-Line Sensors:

MIL-PRF-5606, MIL PRF-83282, MIL-PRF-87257

- K-4385 - 0.5-7 gpm
- K-2339 - 5-26 gpm
- K-4387 - 21-100 gpm

Skydrol, Hyjet

- K-4386 - 0.5-7 gpm
- K-2340 - 5-26 gpm
- K-4388 - 21-100 gpm

Specifications:

Model Number	Fluid Type
06-5051-6500	MIL-PRF-5606, MIL-PRF-83282, MIL-PRF-87257
06-5051-6600	Skydrol, Hyjet



30° Thin Head Wrenches

Use to attach Hydraulic Coupling Hose Adaptor Kits

- Finish: Satin Chrome

Specifications:

Model Number	Size (inches)	Model Number	Size (inches)	Model Number	Size (inches)
H-2920-01	3/4	H-2920-09	1 1/4	H-2920-20	1 7/8"
H-2920-03	7/8	H-2920-12	1 3/8	H-2920-23	2 1/8"
H-2920-05	1	H-2920-14	1 1/2"	K-4013	Includes All Sizes
H-2920-06	1 1/16"	H-2920-16	1 5/8"		
H-2920-07	1 1/8	H-2920-17	1 11/16"		



Fluid Test Kit

Standard Features:

PETROLEUM BASED FLUIDS - K-4008

- Fluids: MIL-PRF-5606, MIL-PRF-83282, MIL-PRF-87257, MIL-L-23699
- Fluid analysis is critical tool for any preventive maintenance program
- Fluid Analysis identifies potential problems that are undetectable by other means
- Mailing container with pre-addressed label
- Pre-cleaned glass bottle
- Analysis Includes:

Particle Count	Spectrometric Analysis	Viscosity Analysis
Photomicrograph	Water Analysis (PPM)	Neutralization Analysis



K-4008

AVIATION PHOSPHATE ESTER FLUID - K-4061

- Fluid: Skydrol® (a registered trademark of Solutia, Inc.)
- Fluid analysis is critical tool for any preventive maintenance program
- Fluid Analysis identifies potential problems that are undetectable by other means
- Mailing container
- Pre-cleaned bottle
- Analysis Includes:

Appearance	Acidity	Moisture	Chemical Composition
Color	Chlorine	Particle Count	



K-4061

“Super Clean” Fluid Sample Bottle

Standard Features:

- Sample method instructions
- Pre-cleaned bottle
- Bottle volume: 110-120 ml



K-4062

Fluid Sample Valve Kit

Standard Features:

PETROLEUM BASED FLUIDS - K-4766

- Fluids: MIL-PRF-5606, MIL-PRF-83282, MIL-PRF-87257, MIL-L-23699
- Fluid analysis is critical tool for any preventive maintenance program
- Fluid Analysis identifies potential problems that are undetectable by other means
- Use to take fluid samples returning from aircraft
- For use on HPU's with #12 JIC return hoses

Standard Features:

- 6.5 HP industrial Briggs & Stratton® engine
- Temperature adjustable to 200° F (93° C)
- Safety relief valve
- Suction strainer
- Type I fluid only
- Positive displacement pump with accumulator
- 50 ft (15 m) output hose
- 250 psi (17 bar) maximum pressure
- 7 gpm (27 lpm) maximum flow
- Sturdy steel trailer with pneumatic tires
- Finish: Durable Powder Coat Tronair Blue frame

Additional Standard Features:

- Models: 09-6200 Series
- 55 gal (208 l) stainless steel reservoir
 - 2 - 3 hour recovery time
60 to 180° F (16 to 82° C)
- Models: 09-6201 Series
- 275 gal (1041 l) steel reservoir with 10 in (25 cm) access cover
 - 11 kw immersion heater
 - 4 - 5 hour recovery time
60 to 180° F (16 to 82° C)



09-6200-0010

Specifications:

Model Number	Voltage	Phase	Max Draw Amp	Length in (cm)	Width in (cm)	Height in (cm)	Weight lb (kg)
09-6200-0010	200/240	3	13	92 (234)	38 (97)	36 (91)	300 (135)
09-6200-0011	220/240	1	23	92 (234)	38 (97)	36 (91)	300 (135)
09-6200-0014	380/415	3	8	92 (234)	38 (97)	36 (91)	300 (135)
09-6200-0016	440/480	3	7	92 (234)	38 (97)	36 (91)	300 (135)
09-6201-0010	200/240	3	33	112 1/2 (286)	73 1/2 (187)	46 (117)	750 (340)
09-6201-0011	220/240	1	57	112 1/2 (286)	73 1/2 (187)	46 (117)	750 (340)
09-6201-0013	200/208	3	35	112 1/2 (286)	73 1/2 (187)	46 (117)	750 (340)
09-6201-0014	380/415	3	19	112 1/2 (286)	73 1/2 (187)	46 (117)	750 (340)
09-6201-0016	440/480	3	16	112 1/2 (286)	73 1/2 (187)	46 (117)	750 (340)

Portable Deicer

Standard Features:

- Model: 09-4003-4010
- 2 1/2 gal (9.5 l) fluid capacity
 - Stainless steel tank
 - 15 ft (4.6 m) #4 hose with quick disconnect fittings
 - 4 to 10.5 ft (1.2 to 3.2 m) telescoping wand assembly
 - Adjustable nozzle allows spray angle control
 - 100 psi (6.9 bar) maximum air pressure
 - Certified pressure gauge indicates safe range
 - Tank handle acts as shut-off valve
 - 9 lb (4 kg) empty weight



09-4003-4010

Service Unit For TKS Fluid

Standard Features:

- Model: 09-5046-6500
- Designed specifically for TKS anti-icing fluid
 - 2 micron filtration
 - 6 gal (23 l) capacity
 - 85 psi (5.9 bar) recommended maximum pressure
 - Safety pressure relief set at 125 psi (8.6 bar)
 - 15 ft (4.6 m) standard outlet hose with instant on/off squeeze handle with #4 tube extension
 - Corrosion resistant ASME certified stainless steel tank
 - 8 in (20 cm) semi-pneumatic tires
 - Extended neck to reach fill port

- Dimensions:
 - Length: 17in (43 cm)
 - Width: 14 in (35.6 cm)
 - Height: 44 in (112 cm)
 - Weight: 44 lb (19 kg) empty



09-5046-6500

Pneumatic Driven Hydraulic Beadbreaker

Standard Features:

- Roll thru design
- 12 adjustable breaker pad settings eliminate the need for ring adaptors
- 12 ton (10,886 kg) hydraulic cylinder driven by an 80 to 120 psi (5.5 to 8.3 bar) pneumatic pump
- Rugged welded steel construction with aluminum breaker spindle
- Pneumatic pumps, single control panel, ramp, and machnical vertical and horizontal travel (OSHA Act 1970 Section 5(a)(1) - General Duty Clause and EU-OSHA Directive 90/269/EEC - Manual Handling of Loads)
- Single control panel allows for both vertical and horizontal travel with a foot pedal control valve
- Entry ramp and sliding rail make loading and positioning easier
- Adjustable to rim sizes 12 to 28 in (30.5 to 71 cm)
- Approved for use on radial tires
- MIL-PFR-5606 hydraulic fluid
- Finish: Durable Powder Coat Tronair Blue

Adaptor Kit:

- K-3151 - Small Tire Adaptor Kit for breaking tires with rim sizes 18 in (45.7 cm) diameter or less

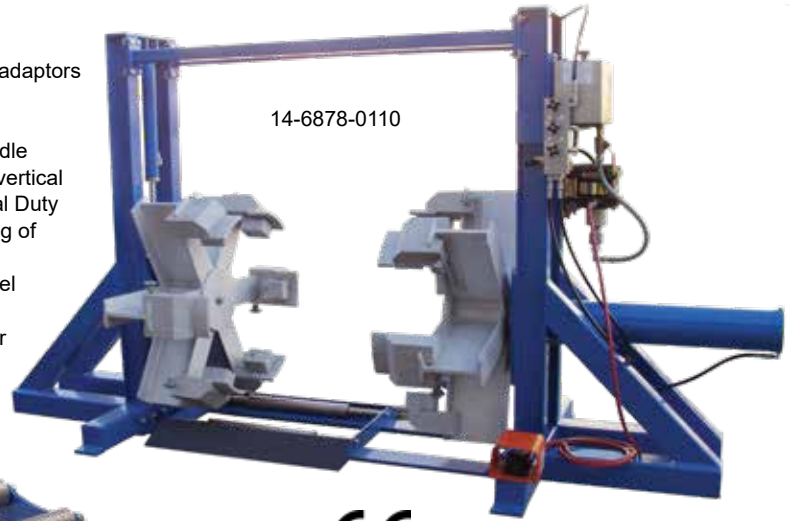

14-6878-0110



K-3151

Specifications:

Model Number	Length in (cm)	Width in (cm)	Height in (cm)	Weight lb (kg)
14-6878-0110	121 (307)	40 (102)	63 (160)	1640 (744)

Anti-Skid Test Units

Standard Features:

- Perform quick and reliable Anti-Skid testing on your Bombardier Aircraft
- Bleed brakes
- Obtain an oil sample
- Measure brake pressure at the calipers
- 15 ft hose
- Aluminum enclosure



14-6872-8100

Specifications:

Model Number	Aircraft	Length in (cm)	Width in (cm)	Height in (cm)	Weight lb (kg)
14-6866-6010	Global Express	9 (22.5)	12.3 (31)	12.4 (31.4)	9 (4)
14-6871-6010	Dash 8 100/300	11 (28)	13 (33)	14.5 (31.4)	9 (4)
14-6888-6000	Dash 8 400	11 (28)	13 (33)	14.5 (31.4)	9 (4)
14-6912-6000	Global Express	7.5 (19)	11 (28)	14.4 (36.6)	9 (4)

Standard Features:

- Sturdy welded steel construction
- Fits tire rim diameters 8 to 20 in (20 to 51 cm) with breaker rings (sold separately)
- Telescoping legs to adjust for tire widths
- Accommodates locking ring type wheel
- Three padded sliding bottom breaker pads to protect against rim damage
- Finish: Durable Powder Coat Tronair Blue

Adaptor Kit:

- K-2540 - 4,500 psi (310 bar) Air pump field installation kit
- K-3721 - 8,000 psi (552 bar) Air pump field installation kit

These Beadbreakers are not functional without a Beadbreaker Adaptor Ring listed below

It is recommend to order 14B6801-0120 for rims 17 in (43 cm) or larger



Specifications:

Model Number	NSN	Pump Type	Pump psi (bar)	Length in (cm)	Width in (cm)	Height in (cm)	Weight lb (kg)
14-6801-0120	4910015181465	foot	--	28 (71)	28 (71)	55 (140)	141 (64)
14A6801-0120	---	pneumatic	2,500 (172)	28 (71)	28 (71)	55 (140)	141 (64)
14B6801-0120	---	pneumatic	8,800 (607)	28 (71)	28 (71)	55 (140)	141 (64)

BEADBREAKER ADAPTOR RINGS

Z-1063 - for tires without chines

Z-1064 - for tires with chines

Z-3072-20 - for 34 x 9.25-16 Goodyear tires

Z-3072-22 - Dunlap wheels and K-3729 - Dunlap rim assembly kit and disassembly kit

To Determine Proper Ring Size:

1. Measure outside diameter of rim
2. Add .55 inches to diameter of rim
3. Choose next largest diameter ring

Example: The rim measures 13.62 in + .55 in = 14.17 in
Order Z-1063-15 or Z-1064-15

Chine - A tire that has been designed to channel water away from aircraft body; usually the nose wheel

For specific application go to the TOOL & EQUIPMENT LIST link at tronair.com

Ring Size in (cm)	Tire w/out chines	Tire with chines
6 (15.24)	Z-1063-06	Z-1064-06
7 (17.78)	Z-1063-07	Z-1064-07
8 (20.32)	Z-1063-08	Z-1064-08
9 (22.86)	Z-1063-09	Z-1064-09
10 (25.40)	Z-1063-10	Z-1064-10
11 (27.94)	Z-1063-11	Z-1064-11
12 (30.48)	Z-1063-12	Z-1064-12
13 (33.02)	Z-1063-13	Z-1064-13
14 (35.56)	Z-1063-14	Z-1064-14
15 (38.10)	Z-1063-15	Z-1064-15
16 (40.64)	Z-1063-16	Z-1064-16
17 (43.18)	Z-1063-17	Z-1064-17
18 (45.72)	Z-1063-18	Z-1064-18
19 (48.26)	Z-1063-19	Z-1064-19
20 (50.80)	Z-3072-20	Z-1064-20

Manual Beadbreaker

Standard Features:

- Rugged welded steel construction
- Simple to operate
- Adjustable for various tire sizes up to 12 in (30.5 cm)
- Rubber padded base to protect tire rims
- Finish: Durable Powder Coat Tronair Blue

Specifications:

Model Number	Length in (cm)	Width in (cm)	Height in (cm)	Weight lb (kg)
14-4039-0010	31 (79)	24 (61)	41 (104)	31 (14)



Landing Gear Dollies

Standard Features:

- Sturdy welded steel construction
- Manually operated hydraulic hand pump
- Swivel caster for maneuverability
- Floor locks
- Finish:
 - Yellow Poly - 14-6838-5110
 - Orange Poly - 14-6872-8100, 14-6873-8100
 - Gray Poly - 14-6887-8100
 - Blue Enamel - 14-6890-0100



Specifications:

Model Number	Manufacturer/Aircraft	Length in (cm)	Width in (cm)	Height in (cm)	Weight lb (kg)
14-6838-5100	Bombardier DeHavilland Global Express	61.5 (156)	48.3 (122.6)	70.3 (178.6)	715 (324)
14-6872-8100	Bombardier DeHavilland Dash 8-400	61 (155)	48 (122)	70 (178)	650 (295)
14-6873-8100	Bombardier DeHavilland Dash 8-400	44.5 (113)	48 (122)	44 (112)	650 (295)
14-6887-8110	Bombardier Canadair CRJ-700	70 (178)	45.3 (115)	104 (264)	725 (329)
14-6890-0100	Bombardier Learjet 45	39 (99)	28 (71)	40.7 (103)	148 (67)
14-6920C0700	Dassault Falcon 6X	69.375 (176)	59.75 (151.8)	46.375 (118)	428 (194)

Wheel & Brake Dolly

Standard Features:

- Sturdy welded steel construction
- Manually operated hydraulic hand pump
- 7 in (18 cm) maximum lift height
- Accommodates tire sizes from 24 to 54 in (61 to 137 cm)
- Adjustable rear swivel caster for tilting the dolly
- Front swivel casters with floor locks
- Padded brake handling adaptor
- 84 in (213 cm) strap assembly for securing load to dolly (OSHA Act 1970 Section 5(a)(1) - General Duty Clause - an employer has the general duty to provide a safe work environment free from known hazards. Potential movement of the load causing it to fall is prevented by the strap assembly in both transport and repositioning)
- 700 lb (318 kg) maximum load capacity
- Finish: Durable Powder Coat Tronair Blue



14-6883-0110

Adaptor Kit:

- K-2965 - Outboard Wheel Support, wheel extension for removing outboard wheels

Specifications:

Model Number	Length in (cm)	Width in (cm)	Height in (cm)	Weight lb (kg)
14-6883-0110	33 (84)	52 (132)	32 (81)	297 (135)

Wheel Dolly

Standard Features:

- Sturdy welded steel construction
- Manually operated with hand wheel
- 5" diameter swivel casters for greater maneuverability in all directions
- 12" corrosion resistant steel rollers with ball bearings
- Distance between rollers:
 - Minimum: 10 in (25.4 cm)
 - Maximum: 24 in (60.96 cm)
- Universal applications
- 350 lb (159 kg) maximum load capacity
- Finish: Durable Powder Coat Tronair Blue



14-6909C0000
(wheel not included)

Specifications:

Model Number	Length in (cm)	Width in (cm)	Height in (cm)	Weight lb (kg)
14-6909C0000	40 (101.6)	21.5 (54.6)	40 (101.6)	52 (23.6)

Brake Service Units

Standard Features:

- Provides a source of clean pressure fluid for servicing aircraft brakes
- 0 to 300 psi (0 to 20.7 bar) outgoing air pressure gauge
- 0 to 5000 psi (0 to 344.7 bar) operating pressure gauge
- Shut off valves for component testing
- 4000 psi (275.8 bar) hi-low pump provides high flow and high pressure capacity
- Bypass valve
- 8 gal (30 l) tank capacity
- Phosphate Ester fluid
- 3 micron absolute filter
- Finish: Durable Powder Coat Desert Sand (14-6814-3600)
Durable Powder Coat Tronair Blue (14-6918-0600)

Additional Standard Features:

- 14-6918-0600
- 0 to 160 psi (0 to 11 bar) incoming air pressure gauge
 - 5000 psi (344.7 bar) air pump provides high flow and high pressure capacity

Kits:

- K-4640 - adds air pump option

Specifications:

Model Number	Length in (cm)	Width in (cm)	Height in (cm)	Weight lb (kg)
14-6814-3600	35.19 (89.4)	15.75 (40)	32.75 (83)	190 (86)
14-6918-0600	35.19 (89.4)	15.75 (40)	32.75 (83)	190 (86)



Brake Bleed Unit

Standard Features:

- Military Approved
- Stainless steel construction
- 2 gal (7.6 l) reservoir
- Sealed fill cap with pressure relief and vacuum breaker valves
- 2 micron filtration (Beta rating > 1000 @ 4 µm per ISO 4572)
- 200 psi (13.8 bar) maximum pressure
- 2 in (5 cm) filler port
- High displacement hand pump (13 strokes per quart)
- 15 ft (4.6 m) #6 hose with 37° JIC female swivel connector
- Bulkhead plate for installation of size #12 bulkhead quick disconnect coupling half
- Adaptor fittings for connecting size #12, MS33656 and MS33657 quick disconnect couplings
- 8 in (20.3 cm) sight glass
- Hose storage bracket

Couplings:

Coupling	Model	NSN
QD Coupling Half	N-2417-06	4730-00-540-1268
QD Bulkhead Half	N-2705-06	4730-00-541-1115
QD Coupling Half	N-2424-06	4730-00-585-0469
QD Bulkhead Half	N-2559-05	4730-00-729-5736
QD With 3/4 Male JIC	N-2539-1212	4730-01-449-9702
45° Bulkhead union Elbow	N-2681-01-S	4730-00-825-0587
Tube Cap, 1/4 JIC	N-2008-03-S	4730-00-808-6848
Tube End Reducer, 3/4 - 1/4 JIC	N-2055-08-S	4730-00-719-2789
3/4 Dust Plug	N-2437-03	5340-00-790-8423

Specifications:

Model Number	Fluid	Length in (cm)	Width in (cm)	Height in (cm)	Weight lb (kg)
1730-EG-180-2	MIL-PRF-5606/MIL-PRF-83282	14.375 (36.5)	10 (26)	21 (53)	18 (8)



Standard Features:

- Low profile
- No need to remove tire when servicing struts
- 14-6911-0100 fits 14" to 30" tire
- 14-6915-0100 fits 14" to 30" dual tires
- 800 lb (362.9 kg) lifting capacity
- Lift range
 - Collapsed 4.75 in (12 cm)
 - Fully extended 21 in (53.34 cm)
- Long handle for ease of lifting
- Wide, heavy duty steel turntable for both nose and main tires
- Easy clamp to lock tire in place
- Relief valve to prevent lifting aircraft
- 2 swivel casters for easy maneuverability
- No mark rubber wheels
- Finish: Durable Powder Coat Tronair Blue



Specifications:

Model Number	Length in (cm)	Width in (cm)	Height (w/out handle) in (cm)	Weight lb (kg)
14-6911-0100	29 (74)	15 (38)	7 (18)	98 (44.5)
14-6915-0100	29 (74)	22 (56)	7 (18)	98 (44.5)

Strut Service Tool

Standard Features:

- Safely exercise aircraft landing gear struts to expel air while servicing them with oil
- Tasks that used to require two technicians up to an hour, can be done by one technician in less than half the time, saving money
- Reduces the possibility of damage to the aircraft pneumatic lifting operation
- Safe and efficient
- 1,500 lb (680 kg) capacity
- 6.5 to 52 in (15.9 to 132 cm) boom lift
- Low profile to fit under most aircraft wings
- Preferred over other methods of strut servicing
- Standard adaptor fits most aircraft including Falcons, Challengers and Learjets
- Finish: Durable Powder Coat Tronair Blue



Adaptor Kits:

- K-4126 - Includes kits K-4127, K-4128, K-4129, K-4130
- K-4127 - Axle Adaptor Assembly (3.340 diameter) for Gulfstream GII, GIII, GIV, GIVSP, G400
- K-4128 - Axle Adaptor Assembly (3.536 diameter) for Gulfstream GII, GIII, GIV, GIVSP, G400
- K-4129 - Axle Adaptor Assembly (3.610 diameter) for Gulfstream GV, GVSP, G350, G450, G500, G550, G650
- K-4130 - Axle Adaptor Assembly (3.840 diameter) for Gulfstream GV, GVSP, G350, G450, G500, G550, G650

NOTE: Aircraft adaptors will vary depending on Gulfstream aircraft model and aircraft service change 155

Specifications:

Model Number	Length in (cm)	Width in (cm)	Height in (cm)	Weight lb (kg)
14-6906-0110	77.25 (196.2)	45.312 (115.1)	33.75 (85.7)	325 (147)
14-6919-0110	81 (205.8)	50 (127)	33.75 (85.7)	325 (147)
14-6923-0110	71.25 (180.9)	41.312 (104.9)	33.75 (85.7)	325 (147)

Wheel/Strut Servicing Adaptors & Connectors

ATTENTION non-North American customers Tronair supplies a standard CGA cylinder connector that will ONLY connect to a North American gas cylinder. Non-North American customers can purchase specific fittings from the International Gas Cylinder Connector Chart or must provide their local gas cylinder connection to ensure proper fit.



Specifications: See pages 101 - 103 for nitrogen servicing and transportation equipment

	Model Number	Description/Purpose	Thread	Max Pressure psi (bar)
1	14-6802-6000	Strut Deflator - deflates tires and struts	.312-32	N/A
2	14-6892-6000	Tire Deflator - tire stem removal tool and deflator	.305-32	N/A
3	H-2482	Tire Thread Adaptor - airline thread adaptor	.305-32 to .482-26	300 (21)
	H-2483	Dual Foot Air Inflator - checking or inflating large bore stems	1/4 NPTF to .482-26	300 (21)
	H-2484	Tire Lock-On Chuck - airline large bore inflation tool	.482-26 to 1/4 NPTF	300 (21)
	K-2419	High Pressure Connector - connector with valve core depressor	.305-32 to 1/8 NPTF	3000 (206.8)
	K-3127	Air Chuck Adaptor Kit - connector with valve core depressor	.305-32 to -06 JIC Flare	300 (21)
	K-3706	High Pressure Connector - high pressure valve connector	.305-32 to -04 JIC Flare	5000 (344.7)
	PC-1011	High Pressure Connector - connector with valve core depressor	.305-32 to -03 JIC Flare	3000 (206.8)

- 1 Hose provided to drain aircraft struts (remove hose when using for tire service)
- 2 .305-32 equals VG8
- 3 .482-26 equals VG12

ATTENTION non-North American customers Tronair supplies a standard CGA cylinder connector that will ONLY connect to a North American gas cylinder. Non-North American customers can purchase specific fittings from the International Gas Cylinder Connector Chart or must provide their local gas cylinder connection to ensure proper fit.

Standard Features:

- Certification documents are provided with all gauges
- Service gauges protected by a rubber boot
- Service gauges are liquid filled to maintain accuracy
- Gauge accuracy:
 - Regulators ASME Grade B 3-2-3
 - except 18-4216-6000 ± Full Scale 2.5%
 - Gauges ± Full Scale 1.5%
 - Digital Gauge ± Full Scale .25%
- All gauges require annual calibration
- Storage container standard for Service and Pressure Gauges



Specifications:

Model Number	Description/Purpose	Pressure Range psi (bar)	Increments psi (bar)	Hose Length in (cm)
14-6804-6000 *	High Pressure Regulator - servicing high pressure with CGA-580	0-2,500 (0-172)	200 (13.8)	180 (457)
14-6829-6000 *	High Pressure Regulator - servicing high pressure with CGA-680	0-4,500 (310)	200 (13.8)	180 (457)
14-6808-6000 *	Low Pressure Regulator - servicing low pressure with CGA-580	0-500 (0-34)	20 (1.4)	180 (457)
14-6805-6010	Strut Service Gauge - inflates struts with nitrogen	0-3,000 (0-207)	50 (3.4)	16 (41)
14-6831-6010	Strut Service Gauge - inflates & deflates struts with nitrogen	0-3,000 (0-207)	50 (3.4)	16 (41)
14-6884-6000	Strut Service Gauge - inflates & deflates struts with nitrogen	0-3,000 (0-207)	50 (3.4)	16 (41)
14-6895-6000	Strut Service Gauge - inflates & deflates struts with nitrogen	0-1,500 (0-103)	10 (.7)	16 (41)
14-6900-6000	Strut Service Gauge - inflates & deflates struts with nitrogen	0-600 (0-41)	5 (0.35)	16 (41)
14-6900-6600	Strut Service Gauge - inflates & deflates struts with nitrogen	0-600 (0-41)	5 (0.35)	16 (41)
14-6903-6000	Strut Service Gauge - inflates struts with nitrogen	0-3,000 (0-207)	50 (3.4)	16 (41)
	Strut Service Gauge - inflates struts with nitrogen	0-600 (0-41)	5 (0.35)	16 (41)
14-6806-6011	Tire Pressure Gauge - aircraft tire pressure gauge	0-300 (0-21)	2 (0.14)	9 (23)
14-6806-6011-A1	Tire Pressure Gauge - aircraft tire pressure gauge	0-300 (0-21)	2 (0.14)	24 (61)
14-6806-6030	Tire Pressure Gauge - aircraft tire pressure gauge	0-300 (0-21)	Digital	9 (23)
14-6877-6012	Tire Pressure Gauge - aircraft tire pressure gauge	0-300 (0-21)	2 (0.14)	15 (38)
14-6921-6000	Tire Pressure Gauge - aircraft tire pressure gauge	0-300 (0-21)	2 (0.14)	16 (41)
14-6807-6011	Tire Service Gauge - inflates tires with nitrogen	0-300 (0-21)	2 (0.14)	15 (38)
14-6807-6011-A1	Tire Service Gauge - inflates tires with nitrogen	0-300 (0-21)	2 (0.14)	120 (305)
14-6807-6011-A2	Tire Service Gauge - inflates tires with nitrogen	0-90 (0-6)	2 (0.14)	18 (46)
14-6807-6030	Tire Service Gauge - inflates tires with nitrogen	0-300 (0-21)	Digital	15 (38)
14-6830-6012	Tire Service Gauge - inflates tires with nitrogen	0-300 (0-21)	2 (0.14)	19 (48)
14-6833-6030 •	Tire Service Gauge - inflates tires with nitrogen	0-300 (0-21)	5 (0.5)	16 (41)
	Strut Service Gauge - inflates struts with nitrogen	0-3,000 (0-204)	Digital	16 (41)
14-6885-6000	Low Pressure Regulator - servicing low pressure with CGA-580	0-500 (0-34)	50 (2) left 200 (10) right	15 (38)
	Tire Service Gauge - inflates tires with nitrogen	0-100 (0-6.9)	2 (0.1)	16 (41)
14-6886-6000	High Pressure Regulator - servicing high pressure with CGA-680	0-4,500 (310)	200 (13.8)	15 (38)
	Tire Service Gauge - inflates tires with nitrogen	0-200 (0-13.8)	4 (0.28)	16 (41)
14-6891-6000	Tire Service Gauge - inflates tires with nitrogen	0-300 (0-21)	5 (0.5)	16 (41)
	Strut Service Gauge - inflates struts with nitrogen	0-600 (0-41)	5 (1.0)	16 (41)
14-6921-6000	Tire Service Gauge - inflates tires with nitrogen	0-300 (0-21)	Digital	16 (41)
	Strut Service Gauge - inflates struts with nitrogen	0-5,000 (0-345)	Digital	16 (41)
18-4216-6000	Low Pressure Regulator - servicing high frequency coupler antenna	0-15 (0-1.03)	1 (0.07)	16 (41)

* Pressure regulator gauges do not have rubber boots or liquid filled gauges
 • Pressure relief set at 90 psi
 All listed service gauges are for .305-32 stems, see previous page for .482-26 adaptors

Hydraulic Maintenance Platforms

Standard Features:

- Sturdy welded steel construction
- 500 lb (227 kg) capacity
- 41 in (104 cm) removable guardrails can be stored in the base (OSHA 1910 Subpart D - Walking Working Surfaces - built in fall protection with guardrails. Removability of guardrail also adds the ability to apply different fall protection techniques that may be more applicable given the situation and work to be done)
- 41 in (104 cm) gated guardrails with self closing hinges - 04-6001-1100-B9 only (OSHA 1910 Subpart D - Walking Working Surfaces - built in fall protection with guardrails. Removability of guardrail also adds the ability to apply different fall protection techniques that may be better applicable given the situation and work to be done)
- Hydraulic cylinder contains 11 mechanical safety locking positions (OSHA Act 1970 Section 5(a)(1) - General Duty Clause - eliminates potential known hazard of mechanical/hydraulic failure by adding mechanical safety locking positions to help prevent the platform from falling)
- Double acting hydraulic hand pump with 3 gal (11 l) reservoir
- Optional air pump on 04-6001-1100 and 04-6005-1100
- Non-slip grating on stair steps and platform (OSHA 1910 Subpart D - Walking Working Surfaces - aides in preventing slips, trips, and falls)
- Toeboard (OSHA 1910 Subpart D - Walking Working Surfaces - built in falling object protection with toe boards)
- Two 8 in (20 cm) swivel casters with foot locks and polyurethane tread wheels for easy maneuvering
- Two 16 in (41 cm) pneumatic wheels
- Detachable towbar for easy maneuvering
- Poly-vinyl bumpers help protect aircraft skin
- Finish: Durable Powder Coat Tronair Blue



Specifications:

Model Number	Type	Platform Height ft (m)	Working Range ft (m)	Raised Height Clearance ft (m)	Platform Size ft (m)	Base Dimensions collapsed - ft (m)	Weight lb (kg)
04-6001-1100 *	B1	3 (.9) to 12 (3.7)	6 (1.8) to 18 (5.5)	15.4 (4.7)	4 (1.2) x 4 (1.2)	5.8 (1.8) x 17.4 (5.3)	1560 (708)
04-6001-1100-B9 *	B1	3 (.9) to 12 (3.7)	6 (1.8) to 18 (5.5)	15.4 (4.7)	4 (1.2) x 4 (1.2)	5.8 (1.8) x 17.4 (5.3)	1560 (708)
04-6005-1100	NA	3 (.9) to 10 (3.0)	6 (1.8) to 18 (5.5)	13.4 (4.1)	4 (1.2) x 11 (3.4)	5.8 (1.8) x 23 (7)	1700 (771)
04-6034-1100	NA	7 (2.0) to 15 (4.6)	10 (3) to 21 (6.4)	18.4 (5.6)	4 (1.2) x 4 (1.2)	5.8 (1.8) x 20.6 (6.3)	2070 (939)
04-6035-1100	B2	10 (3.0) to 19 (5.8)	13 (3.9) to 25 (7.6)	22.4 (6.8)	4 (1.2) x 9 (2.7)	7.8 (2.4) x 27 (8.2)	3330 (1514)
04-6040-0100 *	NA	3 (.9) to 12 (3.7)	6 (1.8) to 18 (5.5)	15.4 (4.7)	4 (1.2) x 4 (1.2)	5.8 (1.8) x 17.4 (5.3)	1560 (708)
04-6041-0100	NA	7 (2.0) to 15 (4.6)	10 (3) to 21 (6.4)	18.4 (5.6)	4 (1.2) x 4 (1.2)	5.8 (1.8) x 20.6 (6.3)	2070 (939)

* K-1824 Stabilizer Kit

Standard Features:

- Sturdy welded steel construction
- Platform size: 3 ft (.9 m) x 8 ft (2.4 m)
- 500 lb (227 kg) capacity
- 48 in (122 cm) removable guardrails
- 48 in (122 cm) gated guardrails with self closing hinges
04-6029-5111-A5, 04-6030-5111-A2 only
(OSHA 1910 Subpart D - Walking Working Surfaces - built in fall protection with guardrails. Removability of guardrail also adds the ability to apply different fall protection techniques that may be more applicable given the situation and work to be done)
- Telescoping ladder reaches raised platform height
- Hydraulic foot pedal pump
- Non-slip composite platform (OSHA 1910 Subpart D - Walking Working Surfaces - aides in preventing slips, trips, and falls)
- Toeboard (OSHA 1910 Subpart D - Walking Working Surfaces - built in falling object protection with toe boards)
- Safety mechanical platform stops (OSHA Act 1970 Section 5(a)(1) - General Duty Clause - eliminates potential known hazard of mechanical/hydraulic failure by adding a mechanical safety stop to help prevent the platform from falling)
- Towbar for easy maneuvering
- 4 swivel casters with foot brake and swivel locks for easy positioning
- Rubber bumpers on platform corners for aircraft protection
- Finish: Durable Powder Tronair Blue



Accessory:

- K-3589 - B4 to B5 conversion

Specifications:

Model Number	Type	Platform Height		Raised Height Clearance ft (m)	Overall Length ft (m)	Width in (cm)	Weight lb (kg)
		Closed in (cm)	Raised ft (m)				
04-6029-5111	B4	41 (104)	7.3 (2.2)	11.3 (3.4)	9 (2.7)	37 (94)	1,400 (635)
04-6029-5111-A5	B4	41 (104)	7.3 (2.2)	11.3 (3.4)	9 (2.7)	37 (94)	1,400 (635)
04-6030-5111-A2	B5	96 (244)	12 (3.6)	16 (4.9)	9 (2.7)	66 (168)	1,500 (680)
04-6030-5111	B5	96 (244)	12 (3.6)	16 (4.9)	9 (2.7)	66 (168)	1,500 (680)
04-6036-0100	B4	47 5/8 (121)	8 (2.4)	12 (3.6)	9 (2.7)	37 (94)	1,500 (680)

Heavy Duty Hydraulic Utility Cranes

Standard Features:

- Heavy duty base and frame provide required counterweight for safe lifting
- Anti-slip mats are placed on all walking surfaces (OSHA 1910 Subpart D - Walking Working Surfaces - aides in preventing slips, trips and falls)
- 2 in (5 cm) boom adjustment increments with seven (7) positions
- Conveniently located controls with hardware and connection points to easily add field options
- Safety fuse prevents the load from dropping in the event of a hydraulic failure (OSHA Act 1970 Section 5(a)(1) - General Duty Clause - eliminates potential known hazard of hydraulic failure by adding a safety fuse to prevent a falling load)
- Heavy duty load bearing wheels in front and swivel casters in rear for easy maneuvering under load
- Manual floor lock to prevent crane movement (OSHA Act 1970 Section 5(a)(1) - General Duty Clause - an employer has the general duty to provide a safe work environment free from known hazards. Movement of a crane while setting or picking is a known hazard. The locking wheels help eliminate this hazard)
- Designed to provide maximum work space
- Finish: Durable Powder Coat Tronair Blue

Accessories:

- K-2012 - Gooseneck Boom Kit
- K-2013 - Airpump Kit
- K-2207 - Cylinder Repair Kit
- K-2953 - Heavy Duty Hand Winch Kit
- K-4105 - Crane Split Collar Kit

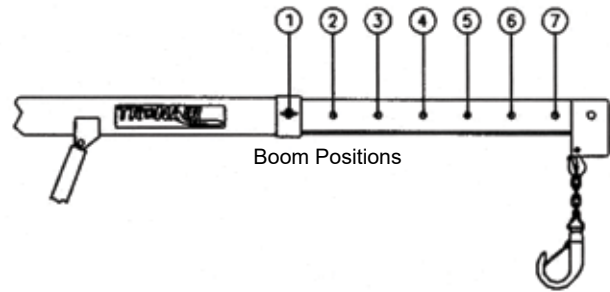

Specifications:

Model Number	Capacity lb (kg) *	Length in (cm)	Width in (cm)	Height in (cm)	Weight lb (kg)
04-6150-0120	4000 (1814)	117 (297)	78 (198)	120 (305)	2,290 (1,039)
04-6152-0120	2750 (1247)	117 (297)	78 (198)	156 (396)	2,399 (1,088)

* Without Gooseneck Boom, Position #7 (retracted)

Crane Boom Shown in Position 4

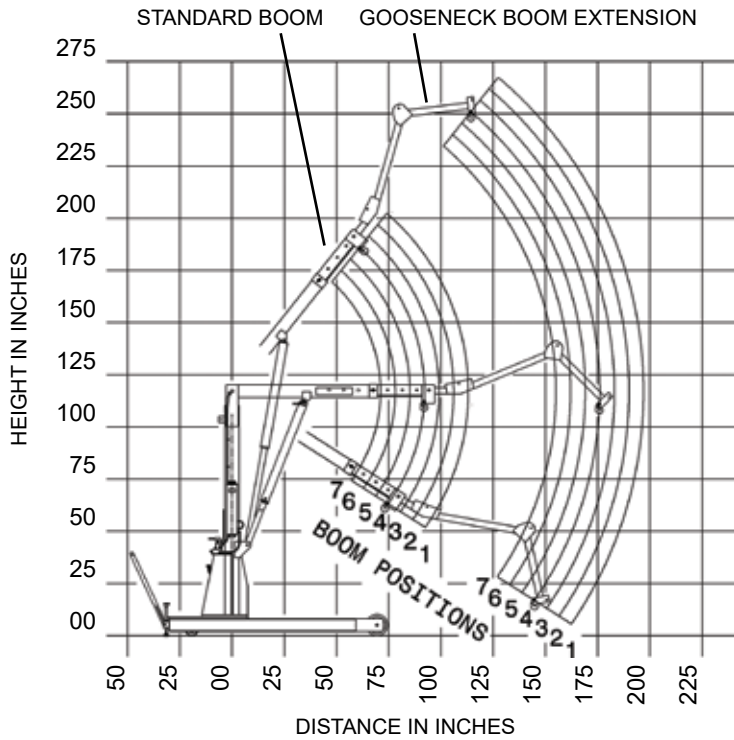

04-6150-0120

Standard Boom

Boom Position	Max Load lb (kg)	Max Height in (cm)
1	1500 (680)	195 (495)
2	1850 (839)	191 (485)
3	2200 (998)	187 (475)
4	2550 (1157)	183 (465)
5	2900 (1315)	179 (455)
6	3250 (1474)	175 (444)
7	4000 (1814)	171 (434)

Gooseneck Boom

Boom Position	Max Load lb (kg)	Max Height in (cm)
1	500 (227)	256 (650)
2	560 (254)	252 (640)
3	720 (327)	248 (630)
4	780 (354)	244 (620)
5	840 (381)	240 (609)
6	900 (408)	236 (599)
7	1000 (454)	232 (589)

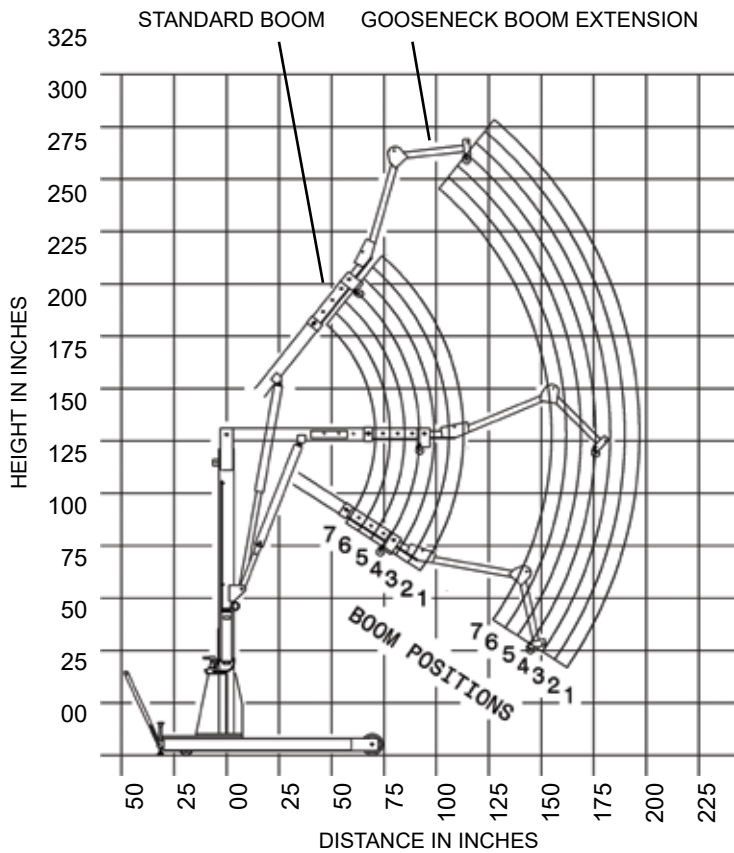

04-6152-0120

Standard Boom

Boom Position	Max Load lb (kg)	Max Height in (cm)
1	1350 (612)	231 (587)
2	1850 (839)	227 (576)
3	2200 (998)	223 (566)
4	2500 (1134)	219 (556)
5	2750 (1247)	215 (546)
6	2750 (1247)	211 (536)
7	2750 (1247)	207 (526)

Gooseneck Boom

Boom Position	Max Load lb (kg)	Max Height in (cm)
1	500 (227)	292 (741)
2	560 (254)	288 (731)
3	600 (272)	284 (721)
4	640 (381)	280 (711)
5	700 (318)	276 (701)
6	750 (340)	272 (691)
7	800 (363)	268 (681)

Universal Lifts

Standard Features:

- Sturdy welded steel construction
- Manual or hydraulically operated models
- Swivel casters for easy maneuvering
- Pivoting arm maintains horizontal lifting point 04-6028C0121
- Interchangeable attachment for custom applications 04-6028C0121 (sold separately)
- 04-6051-0000 comes equipped with G650 adapter
- Finish: Durable Powder Coat Tronair Blue

Accessories:

- K-3057 - Crane attachment
- K-3189 - Lear 45 wing flaps removal fixture
- K-4664 - Lear 45 APU Lift
- K-3712 - ERJ-135/145 battery platform
- K-3853 - Horizon APU adaptor
- K-4400 - GIV, GV, GVSP, GIVSP, G450, G500, G550, G650 battery lift kit
- K-4617 - Bombardier C Series APU Lift
- Z-4082 - Battery lifting platform



Specifications:

Model Number	Manufacturer/Aircraft	Operation	Range in (cm)	Length in (cm)	Width in (cm)	Weight lb (kg)
04-6032-0100 *	Embraer ERJ 135, ERJ 145, Legacy	Hydraulic	14 (36) to 87 (221)	82 (208)	50 (127)	265 (120)
04-6033-0100	Horizon APU Hoist	Hydraulic	12 (31) to 84 (213)	82 (208)	50 (127)	302 (134)
04-6028C0121 *	Universal	Hydraulic	12 (31) to 84 (213)	82 (208)	50 (127)	265 (120)
04-6051-0000	Gulfstream G450, G500, G550, G650, G600, G650, Gulfstream V, VSP	Hand Pump	30 ¼ (77) to 120 (305)	94.6 (240)	58 ½ (148)	486 (220)
04-6052-0000	Embraer E-175-E2	Hand Pump	30 ¼ (77) to 135 ¾ (344)	80 ½ (204)	51 (128)	285 (129)
04-6054-0000	Bombardier Global 7500	Hydraulic	13 (33) to 85 (216)	84.25 (214)	51 (128)	265 (120)

* Maximum Capacity 500 lb (227 kg)

Battery Lifts

Standard Features:

- Sturdy welded steel construction
- Manual or hydraulically operated models
- Swivel casters for easy maneuvering
- 300 lb (136 kg) maximum vertical lift 04-6031-0100
- 100 lb (45 kg) maximum vertical lift
- Finish: Durable Powder Coat Tronair Blue
Light Gray Enamel 04-6027-0110



Specifications:

Model Number	Manufacturer/Aircraft	Operation	Lift Capacity lb (kg)	Range in (cm)	Length in (cm)	Width in (cm)	Weight lb (kg)
04-6000-0910	Bombardier Learjet & others	Hydraulic	100 (45)	27 (69) to 45 (114)	18 (46)	18 (46)	35 (16)
04-6044-0100	Bombardier Global 7500/8000	Hydraulic	250 (113)	28 ¾ (73) to 48 ¼ (123)	30 (76)	30 (76)	40 (18)
04-6031C0100	Dassault Falcon 900	Hydraulic	300 (136)	47 (119) to 82 (208)	46 (117)	54 (137)	90 (41)
04-6027-0110	Hawker Beechcraft JPATS	Hydraulic	100 (45)	31 (78) to 49 (124)	18 (46)	18 (46)	45 (20)
04-6014-0010	Raytheon HS-125 (all)	Hand Winch	100 (45)	36 (91) to 88 (224)	27 (69)	24 (61)	54 (25)
04-6046-0100	Pilatus PC-12, PC-24	Hydraulic	100 (45)	38 ¼ (97) to 61 ¾ (156)	38 ¼ (97)	50 (127)	100 (45.4)

Standard Features:

- Finish:
 - 08-0116-5000 - Yellow Enamel
 - 08-0132-0000 & 08-0136-0010 - Durable Powder Coat Tronair Blue
 - 08-0137-6000 - Aluminum
- 08-0137-6000 mount in fuselage to lift small components

Upgrade Kit:

- K-3963 - Convert 08-0136-0000 to 08-0136-0010
(requires unit to be returned to factory for installing and testing)



Specifications:

Model Number	Manufacturer/Aircraft	Rated Work Load lb (kg)	Usage	Length in (cm)
08-0116-5000	Bombardier Canadair CL-215T, CL-415	1,550 (703)	Engine	80 (203)
08-0132-0000	Bombardier deHavilland Dash-8 100-300	1,550 (703)	Engine	78 (198.1)
08-0136-0010	Bombardier deHavilland Dash-8 400	2,000 (907.2)	Engine	133 (337.8)
08-0137-6000	Bombardier Canadair CRJ-700	250 (113)	Components	55.5 (141)

Propeller Stands

Standard Features:

- Store and transport propellers
- Sturdy welded steel construction
- Heavy duty casters for easy maneuvering
- Finish: Durable Powder Coat Tronair Blue

Mandrell Kits:

08-2033C0000 is a base only, requires Mandrell

- K-5433 - Mandrell, Cessna 402
Hartzell HC-E4N-2X
Hawker Beechcraft C-12, King Air
- K-5434 - Mandrell, Cessna Denali
- K-5435 - Mandrell, Cessna Skycourier 408



Specifications:

Model Number	Manufacturer/Aircraft	Length in (cm)	Width in (cm)	Height in (cm)	Weight lb (kg)
08-2016-0000	ATR 42	157.5 (400)	70 (178)	96 (244)	976 (443)
08-2028-0000	Fairchild/Dornier Dornier 328	157.5 (400)	70 (178)	96 (244)	976 (443)
08-2031-0000	BAe Jetstream 500	54.25 (138)	67.25 (171)	56.25 (143)	456 (207)
08-2033C0000	Cessna 402, Denali, Skycourier 408 Hartzell HC-E4N-2X Hawker Beechcraft C-12, King Air	54.25 (138)	67.25 (171)	67.75 (172)	285 (129)
08-2039-0000	Embraer A-29 Super Tucano	54.25 (138)	67.25 (171)	67.75 (172)	300 (136)

WALL MOUNT PROPELLER STANDS



Specifications:

Model Number	Manufacturer/Propeller	Length in (cm)	Width in (cm)	Height in (cm)	Weight lb (kg)
08-0503-4000	Hartzell HD-E6C-3	12.5 (31.8)	8 (20)	8 (20)	22 (10)
08-0504-4000	Hamilton Standard 14SF-7, 14SF-23	13 (33)	8 (20)	8 (20)	22 (10)
08-0505-4000	Hartzell HC-E5N-3AL	8 (20)	5.5 (14)	5.5 (14)	20 (9)

Propeller and Blade Slings

Specifications:

Model Number	Manufacturer/Propeller/Blade
08-0111-6000	Hamilton Standard 14SF-7 Blade
08-0115-4000	Hamilton Standard 14SF-7 Propeller



Propeller Tools

Specifications:

Model Number	Usage
08-0701-4000	Span Wrench
08-0702-6000	Propeller Pitch Change Tool
08-0703-6000	Propeller Seal Tool
08-0704-4000	Propeller Torque Adaptor Tool
08-0705-6000	Propeller Torque Motor Removal Tool

Model Number	Usage
08-8050-6000	Power Lever Rigging Tool
08-8051-6000	Condition Lever Rigging Tool
08-8056-6000	Propeller Seal Tool
08-8064-4000	Propeller Torque Adaptor Tool
08-8077-6000	Propeller Torque Motor Removal Tool



Standard Features:

- Heavy duty welded steel construction
- Easy maneuvering with 2 swivel and 2 rigid heavy duty casters
- Rigid casters equipped with floor locks
- Handy oil recovery pan to avoid damage to hanger floors
- Easily converted to accept left and right hand engines
- Multiple engine adaptability (engine adaptor kits sold separately)
- Removable towbar with storage hooks
- Adaptors change in minutes
- Finish: Durable Powder Coat Tronair Blue

Adaptor Kits:

08-2030-0000 - 08-2034-0010

- K-2685 - Pratt & Whitney PW530A
- K-2769 - Pratt & Whitney PW545A
- K-2770 - Garrett TFE731-1 to 5
- K-2776 - Pratt & Whitney JT15D-1 to 5
- K-2808 - Garrett TFE731-20
- K-3068 - Pratt & Whitney PW535
- K-4093 - Pratt & Whitney PWC127

08-2034-0010 only

- K-3152 - Pratt & Whitney PW306A
- K-3618 - Pratt & Whitney PW308A
- K-3842 - Pratt & Whitney PW306C, PW306D
- K-4192 - Hawker 900XP 731-50R Engine



08-2034-0010

Standard Features:

Model: 08-2037-0000

- Heavy duty welded steel construction
- One ton lift capacity
- Electric motor operated
- Adjustable from 30 to 73 inches at engine centerline
- Easy maneuvering with 4 lockable, swivel heavy duty casters
- Easily converted to accept left and right hand engines
- Multiple engine adaptability (engine adaptor kits sold separately)
- Removable towbar with storage hooks
- Anti-slip mats on all work/walking surfaces
- Finish: Durable Powder Coat Tronair Blue

Adaptor Kits:

- K-4662 - Garrett TFE731-20
- K-4663 - Pratt & Whitney PW305



08-2037-0000

Specifications:

Model Number	Manufacturer/Engine	Length in (cm)	Width in (cm)	Height in (cm)	Weight lb (kg)
08-2014-0000	Pratt & Whitney PW100	86 (218)	38 (97)	45 (114)	540 (245)
08-2018-0000	Pratt & Whitney PW305	105 (267)	49 (125)	63 (160)	550 (250)
08-2029-0000	Rolls Royce (Allison) AE-3007-C	120 (305)	61 (155)	83 (211)	960 (435)
08-2030-0000	Various See Adaptor Kits	73 (185)	55 (140)	60 (152)	485 (220)
08-2034-0010	Various See Adaptor Kits	133 (338)	70 (178)	60 (152)	650 (295)
08-2037-0000	Pratt & Whitney PW307B	102 (259)	105 (267)	85 (216)	4,000 (1,814)

Multi-Purpose Rotating Turbine Engine Work Stands

Standard Features:

- Manual gear driven 360° rotation with safety locks at 3° intervals
- Sturdy welded steel construction
- Towbar stores away for ease of engine maintenance
- Heavy duty 6 in (15 cm) casters with 2 swivel and 2 rigid for easy maneuvering
- Two foot operated floor locks stabilize stand during maintenance operation
- Handy oil recovery pan to avoid damage to hangar floors
- Multiple engine adaptability (engine adaptor kits sold separately)
- Non-slip work/walking surfaces
- Adaptors change in minutes
- Finish: Durable Powder Coat Tronair Blue



08-2021C0000

Adaptor Kits:

08-2021C0000

- K-1795 - Garrett TFE731-1 to 5
- K-1796 - Pratt & Whitney JT15D
- K-2032 - Williams FJ44
- K-3215 - Garrett TFE731-20 & 40
- K-3861 - Garrett TFE731-60
- K-3994 - Pratt & Whitney PW615F-A
- K-4030 - Williams FJ33
- K-4071 - Pratt & Whitney PW615F-A Lord Mounting
- K-4190 - Williams FJ44-4

08-2220C0000

- K-4009 - Williams FJ33
- K-4131 - Williams FJ44-4

Specifications:

Model Number	Capacity lb (kg)	Length in (cm)	Width in (cm)	Height in (cm)	Weight lb (kg)
08-2021C0000	1,000 (453.6)	40 (102)	56 (142)	51 (42)	375 (170)
08-2220C0000	500 (226.8)	32 (81)	43 (109)	52 (107)	300 (136)

Standard Features:

- 45° positioning wheel with ball lock pin secures engine giving 8 angles of maintenance access
- Sturdy welded steel construction
- Easy maneuvering with 2 swivel and 2 rigid heavy duty casters
- Center foot operated grips firmly to stabilize stand during maintenance operation
- Handy oil recovery pan to avoid damage to hanger floors
- Finish: Durable Powder Coat Tronair Blue

Adaptor Kits:

- K-2108 - Rolls Royce (Allison) 250-C18, 20, C28, 30
- K-2110 - Garrett TPE331
- K-2111 - Lycoming LTS101



08-2023-0010

Specifications:

Model Number	Length in (cm)	Width in (cm)	Height in (cm)	Weight lb (kg)
08-2023-0010	33 (84)	40 (102)	44 (112)	169 (77)

Standard Features:

- Heavy duty 8 in (20 cm) casters
- Sturdy welded steel construction
- Floor locks for stability
- Finish: Durable Powder Coat Tronair Blue

Adaptor Kits:

- K-2112 - Garrett TFE731-1 to 5
- K-2113 - General Electric CF700
- K-2114 - General Electric CJ610
- K-2115 - Pratt & Whitney PT6A-1 to 3 & 36
- K-2116 - Pratt & Whitney PT6A-38/41 to 65 (except A50)
- K-2117 - Pratt & Whitney JT15D

Slings: Can become integral part of stand

- 08-0100-4000 - General Electric CF700 & CJ610
Pratt & Whitney PT6A-1 to 36
- 08-0102-4010 - Garrett TFE731-1 to 5
Pratt & Whitney PT6A-B36, PTA6A-38 & 41 to 65 (except 50)
- 08-0114-4010 - Pratt & Whitney JT15-D-1B, 4B, 4D, 5, 5D
(JT15D-5D requires adaptor kit K-2478)

Engine Sling
(not included,
see Engine Slings)

Engine Adaptor
(not included,
see Adaptor Kits)

08-2001-0000



Specifications:

Model Number	Length in (cm)	Width in (cm)	Height in (cm)	Weight lb (kg)
08-2001-0000	49 (125)	52 (132)	73 (185)	350 (159)

Engine Slings



Specifications:

Model Number	Capacity lb (kg)	Manufacturer/ Engine	Required Adaptor Kit
08-0100-4000	900 (408)	General Electric - CF700 & CJ610	K-4836 (CJ610)
		Pratt & Whitney - PT6A-1 to 36	NA
08-0102-4010	1,100 (499)	Garrett - TFE731 Pratt & Whitney - PT6-41, PT6A-65B, PTA-67D, PT6-B36 General Electric - CATALYST1300-CS1A	NA
08-0103-4000	1,000 (454)	Garrett - TPE331	NA
08-0104-4000	300 (136)	Rolls Royce (Allison) - 250	NA
08-0106-4000	600 (272)	General Electric - CT-7	NA
08-0112-4000	1,170 (531)	Pratt & Whitney - PW100 Series (except PW119B)	NA
08-0113-4000	600 (272)	Pratt & Whitney - PW120 Reduction Gear Box	NA
08-0114-4010	695 (315)	Pratt & Whitney - JT15D-1B, 4B, 4D, 5	NA
		Pratt & Whitney - JT15D-5D	K-2478
08-0119-8000	850 (386)	Williams - FJ44, 1, 2, 3	NA
08-0120-4000	917 (416)	Pratt & Whitney - PT6A-50	NA
08-0121-4010	1,500 (680)	Pratt & Whitney - PW305	NA
08-0126-4000	1,000 (454)	Pratt & Whitney - PW118, 119B	NA
08-0127-4000	600 (272)	Williams - FJ44-1C	NA
08-0129-4000	2,500 (1,134)	Rolls Royce (Allison) - AE-3007-C	NA
08-0130-4000	1,500 (680)	Pratt & Whitney - PW530A, PW545A	NA
08-0133-4000	4,000 (1,814)	Garrett - TFE730-20-1B	K-2809
		Garrett - TFE731-2	K-2897
		Lycoming - LTS-101	K-2908
		Williams FJ-44-1A, FJ-44-2C	K-2866
		Williams FJ-44-1C	K-2867
		Pratt & Whitney - PT6A-50	K-2906
08-0134-4000	2,500 (1,134)	Garrett - TFE730-20-1B	K-2809
		Garrett - TFE731-2	K-2897
		Lycoming - LTS-101	K-2908
		Pratt & Whitney - PT6A-50	K-2906
		Pratt & Whitney - JT15D-1, 4 (2), 5	K-2850
		Pratt & Whitney - JT15D-4 (2)	K-2851
		Pratt & Whitney - PW530A, PW545A	K-2868
		Pratt & Whitney - PT6-41, 42, 60	K-2898
		Pratt & Whitney - PT6-B36	K-2899
		Pratt & Whitney - PW535	K-3067
		Pratt & Whitney - PW615F	K-4072
		Williams FJ-44-1A	K-2866
		Williams FJ-44-1C	K-2867
		Williams FJ-44-2C	K-2866



08-0135-4000



08-0140-4000



08-0149C4000

Specifications:

Model Number	Capacity lb (kg)	Manufacturer/ Engine	Required Adaptor Kit
08-0135-4000	2,500 (1,134)	Garrett - TFE730-20-1B	K-2809
		Garrett - TFE731-2	K-2897
		General Electric - CT-7-5A	K-2909
		Lycoming - LTS-101	K-2908
		Pratt & Whitney - PT6A-50	K-2906
		Pratt & Whitney - JT15D-1, 4 (2), 5	K-2850
		Pratt & Whitney - JT15D-4 (2)	K-2851
		Pratt & Whitney - PW530A, PW545A	K-2868
		Pratt & Whitney - PW120	K-2869
		Pratt & Whitney - PW-119B	K-2877
		Pratt & Whitney - PW305	K-2896
		Pratt & Whitney - PT6-41, 42, 60	K-2898
		Pratt & Whitney - PT6-B36	K-2899
		Pratt & Whitney - PW535	K-3067
		Pratt & Whitney - PW306A, PW3066	K-3126
		Pratt & Whitney - PW615F	K-4072
		Williams FJ-44-1A	K-2866
		Williams FJ-44-1C	K-2867
08-0138-4000	1,400 (635)	Pratt & Whitney - PW306A	NA
08-0139-4000	1,900 (862)	Pratt & Whitney - PW306B	NA
08-0140-4000	1,000 (454)	Pratt & Whitney - PW535	NA
08-0141-4000	1,000 (454)	Garrett - TFE-731-20R-1B	NA
08-0142-4000	1,000 (454)	Garrett - TFE731-40R/200G	NA
08-0143-4000	1,650 (748)	Pratt & Whitney - PW306C	NA
08-0144-4000	1,900 (862)	Pratt & Whitney - PW308A, PW308C	NA
08-0145C4000	450 (204)	Pratt & Whitney - PW615F-A	NA
08-0147C4000	850 (386)	Williams FJ-44-4	NA
08-0149C4000	2,000 (907)	Pratt & Whitney - PW307B	NA
08-8023-4000	600 (272)	Pratt & Whitney - PW120 Reduction Gear Box	NA

Portable Engine Compressor Washers

Standard Features:

- 2 1/2 gal (9.5 l) fluid capacity
- Stainless steel tank
- 16 ft (5 m) #4 hose with quick disconnect fittings
- Charged with 100 psi (6.9 bar) maximum shop air
- Certified pressure gauge indicated safe range
- 9 lb (4 kg) empty weight
- 08-4014-4010 Aircraft connector assembly, no wand
- 08-4040-4010 22 in (56 cm) wand assembly with adjustable spray nozzle



08-4040-4010

Standard Features:

- Two 3-gallon pressure tanks
- Stainless steel fluid tanks with large fill ports
- Requires 125 psi (8.6 bar) shop air
- Pressure regulator with certified pressure gauge provided for flow control
- In-line check valve prevents fluid from flooding regulator
- Three-way direction pressure valve
- Pressure release valve for each tank
- Agitation tube for cleaning solution tank
- Wash and rinse output fluid is filtered
- Quick disconnects have check valves to keep vessel pressurized and fluid from leaking out of the hose
- 1/4 I.D. delivery hose, 14 ft long
- Delivery hose comes with a 1/2 ball valve shutoff
- Wheels and handle for mobility
- Handle can be removed
- Hose can be stored in the container



08-4060-6700

Specifications:

Model Number	Length in (cm)	Width in (cm)	Height in (cm)	Weight lb (kg)
08-4060-6700	28 (71)	10 (25)	44 (112) with handle 21.5 (54.6) with out handle	48 (22)

Standard Features:

- Stainless steel fluid tanks with large fill ports, bleed-off valve and safety pop-off valve
- Requires 125 psi (8.6 bar) shop air
- Pressure regulator with certified pressure gauge provided for flow control
- Solution agitation circuit
- 2 - ASME certified steel compressed air storage tanks with drain valves (1 on 08-4048-0013)
- Sturdy welded steel frame
- 25 micron output filter
- Foot brake
- Finish: Durable Powder Coat Tronair Blue

Additional Features:

Models: 08-4048-0013, 08-4049-0013

- 4 ft (1.2 m) wand assembly with shut-off valve
- Spray wand with 20 ft (6 m) hose and 4 nozzles:
 - 1.5 gpm (6 lpm), 3 gpm (11 lpm), 6 gpm (23 lpm), 10 gpm (38 lpm)

Model: 08-4053-0013

- No wand, T-hose attachment

Model: 08-4058-0013

- No wand, hose attachment

Model: 08T4049-0013

- PT-6 Fuel Nozzle Cleaner

Adaptor Kits:

- K-1057 - Garrett TPE331
- K-2248 - General Electric CFM56
- K-1152 - Pratt & Whitney PT6
- K-4590 - Bell 429
- K-3803 - Bombardier Challenger 300
- K-1710 - Canadair CRJ100, Challenger
- K-1243 - Cessna Caravan
- K-3202 - Cessna Citation X
- K-2714 - deHavilland Dash-8 100/300
- K-1709 - deHavilland DHC6, Twin Otter
- K-4500 - Eurocopter (with Turbomeca Arriel/Makila engines)
- K-1269 - Raytheon King Air
- K-1953 - Rolls Royce (Allison) 250-C20J
 - Bell 206B-JR3
 - Sikorsky S76A
- K-1357 - Saab 340
- K-3979 - Sikorsky S92
- K-4464 - Sikorsky S76B, S76C, S76D



08-4049-0013

Specifications:

Model Number	Wash & Rinse Tank Capacity gal (l)	Length in (cm)	Width in (cm)	Height in (cm)	Weight lb (kg)
08-4048-0013	7 (27)	33 (84)	29 (74)	52 (132)	152 (69)
08-4049-0013	12 (45)	33 (84)	29 (74)	52 (132)	266 (121)
08-4053-0013	12 (45)	33 (84)	29 (74)	53 (135)	266 (121)
08-4058-0013	12 (45)	33 (84)	29 (74)	53 (135)	266 (121)

Standard Features:

- 08-4044-0010 200 gal (757 l) tank
- 08-4044-0010-A2 68 gal (257 l) wash tank, 136 gal (515 l) rinse tank
- Trailer mounted
- Pump powered by 6.5 Hp engine
- Spray wand with 30 ft (9 m) hose
- Sturdy welded steel frame
- Finish: Durable Powder Coat Tronair Blue

08-4044-0010



Specifications:

Model Number	Length in (cm)	Width in (cm)	Height in (cm)	Weight lb (kg)
08-4044-0010	90 (229)	46 (117)	45 (114)	748 (339)
08-4044-0010-A2	90 (229)	46 (117)	45 (114)	748 (339)

Phenom 100 & 300 Aircraft Tooling

Tronair manufactures aircraft tooling for many aircraft. The tooling is custom designed to meet the specific requirements of each task performed with precision and accuracy.



Main Door Dolly



Aircraft Leveling Plumb



Clamp Locking Set



NLG Actuator Removal/Installation Device



Control Surface Deflection Protractor



Fuel Leakage Test Box



Backlash Measurement Set

Specifications:

Model Number	Description	Aircraft
AGE-04510-401	Jacking Adaptor Set	Phenom 100
2310-T030-401	Nose Landing Gear Wheel Changing Support	Phenom 100
AGE-05118-401	Static Port Protection Plug	Phenom 100
AGE-04713-401	Cabin Adaptor-Pressurization Test Tool	Phenom 100, 300
AGE-05102-403	Air Data Computer Calibration Set	Phenom 100
AGE-04701-401	Fuel Leakage Test Box	Phenom 100, 300
AGE-04540-401	Fuel Tanks Leakage Adaptor	Phenom 100, 300
AGE-04629-401	Hose Assembly Short	Phenom 100, 300
AGE-04629-403	Hose Assembly Long	Phenom 100, 300
AGE-03841-401	Brake Pressure/Bleed Hose Tool	Phenom 100
2310-T001-001	Landing Gear Pintle Pins Removal/Installation Device	Phenom 100, 300
2310-T020-401	NLG Actuator Removal/Installation Device	Phenom 100
AGE-04720-401	MLG Proximity Switch	Phenom 100
AGE-04871-401	Aircraft Leveling Plumb	Phenom 100, 300
AGE-04714-401	Rigging Pin Set	Phenom 100
AGE-00387-401	Control Surface Deflection Protractor	Phenom 100
AGE-04264-401	Control Cables Tension Adjusting Clip	Phenom 100, 300
AGE-04715-401	Control Surface Support Balancing Tool	Phenom 100, 300
AGE-04550-401	Main Door Eccentrics Wrench Set	Phenom 100, 300
AGE-04520-401	Main Door Dolly	Phenom 100, 300
AGE-04691-401	Aircraft Alignment Set	Phenom 100
AGE-04718-401	Backlash Measurement Set	Phenom 100, 300
AGE-04780-401	Clamp Locking Set	Phenom 100
AGE-04560-403	Engine Dolly	Phenom 100, 300
K-4281	CPU Adaptor	Phenom 100, 300



Door Safety Collar

Trunion Pin Extractor

Trunion Pin Alignment

Folding Side Brace Wrench

Downlock Springs Installation and Removal

Ground Lock Pin

Specifications:

Model Number	Description
99-7117-6000	NLG Ground Lock Pin
99-7118-6000	MLG Ground Lock Pin
99-7120-6000	MLG Axle Nut Threads Protection
99-7121-6000	NLG & MLG Downlock Springs Installation and Removal Tool
99-7122-6000	NLG Trunion Pin Extractor Tool
99-7123-6000	MLG FWD Trunion Pin Extractor Tool
99-7124-6000	NLG Trunion Pin Alignment Tool
99-7125-6000	MLG AFT Trunion Pin Extractor Tool
99-7126-6000	MLG FWD Trunion Pin Alignment Tool
99-7127-6000	MLG AFT Trunion Pin Alignment Tool
99-7131-6000	Door Safety Collar NLG
99-7132-6000	Door Safety Collar MLG
99-7133-6000	MLG Folding Side Brace Wrench
99-7169-6000	MLG Flight Simulation Targets
99-7170-6000	MLG Ground Simulation Targets
99-7171-6000	NLG Flight Simulation Targets
99-7172-6000	NLG Ground Simulation Targets



COMMERCIAL AND
REGIONAL AVIATION



BUSINESS AND
GENERAL AVIATION



MILITARY



ROTOCRAFT

TRONAIR®

1 Air Cargo Pkwy East
Swanton, OH 43558
USA

1.800.426.6301
sales@tronair.com

Asia
622.212.1463
tronairasia@tronair.com

Australia &
New Zealand
61.2.4028.6981

China, Hong Kong, Macau,
& Taiwan
86.137.6450.1982

Europe, Middle East,
& Africa
44 (0) 798.882.3897
saleseurope@tronair.com

tronair.com
ebiscloud.com
columbusjack.com
eagletags.com
malabar.com

ENABLING SAFE FLIGHT

Ordering Replacement Parts:

- Replacement parts do not appear in this catalog. A Tronair Operation and Service Manual or Illustrated Parts List is included with all Tronair products.
- To order replacement parts, be prepared to provide the following information:
 - a) Model number as it appears on unit
 - b) Serial number as it appears on unit
 - c) Call Customer Service at 419-866-6301 or 1-800-426-6301

Limited Warranty

Tronair products are warranted to be free of manufacturing or material defects for a period of one year after shipment to the original customer. This is solely limited to the repair or replacement of defective components. This warranty does not cover the following items:

- a) Parts required for normal maintenance
- b) Parts covered by a component manufacturers warranty
- c) Replacement parts have a 90-day warranty from date of shipment

If you have a problem that may require service, contact Tronair immediately. Do not attempt to repair or disassemble a product without first contacting Tronair, any action may affect warranty coverage. When you contact Tronair be prepared to provide the following information:

- a) Product Model Number
- b) Product Serial Number
- c) Description of the problem

If warranty coverage is approved, either replacement parts will be sent or the product will have to be returned to Tronair for repairs. If the product is to be returned, a Return Material Authorization (RMA) number will be issued for reference purposes on any shipping documents. Failure to obtain a RMA in advance of returning an item will result in a service fee. A decision on the extent of warranty coverage on returned products is reserved pending inspection at Tronair. Any shipments to Tronair must be shipped freight prepaid. Freight costs on shipments to customers will be paid by Tronair on any warranty claims only. Any unauthorized modification of the Tronair products or use of the Tronair products in violation of cautions and warnings in any manual (including updates) or safety bulletins published or delivered by Tronair will immediately void any warranty, express or implied.

The obligations of Tronair expressly stated herein are in lieu of all other warranties or conditions expressed or implied. Any unauthorized modification of the Tronair products or use of the Tronair products in violations of cautions and warnings in any manual (including updates) or safety bulletins published or delivered by Tronair will immediately void any warranty, express or implied and Tronair disclaims any and all liability for injury (WITHOUT LIMITATION and including DEATH), loss or damage arising from or relating to such misuse.

Payment Terms

- 30-day credit terms to customers based on approval by Tronair.
- New customers may apply for credit by furnishing bank and trade references.
- Terms to customers that have not established credit with Tronair are credit card or cash in advance.
- MasterCard, Visa and American Express are accepted.

Freight Terms

- All shipments are FOB factory.
- Same day shipments are subject to a service charge.
- Return shipments must be pre-approved by Tronair and freight prepaid.



Setting the worldwide standard in GSE.